



Main

Range of product	Preventa Safety detection
Accessory / separate part category	Protection accessories
Accessory / separate part type	Protective screen
Product compatibility	XUSL.E...31
Accessory / separate part destination	Safety light curtain type 2 Safety light curtain type 4
Height	345 mm
Quantity per set	Set of 4

Complementary

Material	Polycarbonate
Sensing distance reduction coefficient	0.97 Sn
Product weight	0.14 kg

Environment

Resistance to chemical agents	Resistant alkalis Resistant aqueous solutions Resistant detergents and cleaners Resistant to inorganic diluted acids
Ambient air temperature for operation	-10...55 °C 14...131 °F
Ambient air temperature for storage	-25...70 °C -13...158 °F

Offer Sustainability

Sustainable offer status	Green Premium product
RoHS (date code: YYWW)	Compliant - since 1425 - Schneider Electric declaration of conformity
REACH	Reference not containing SVHC above the threshold
Product environmental profile	Available Download Product Environmental
Product end of life instructions	Available Download End Of Life Manual

The information provided in this documentation contains general descriptions and/or technical characteristics of the products contained herein. This documentation is not intended as a substitute for and is not to be used for determining suitability or reliability of these products for specific user applications. It is the duty of any such user or integrator to perform the appropriate and complete risk analysis, evaluation and testing of the products with respect to the relevant specific application or use thereof. Neither Schneider Electric Industries SAS nor any of its affiliates or subsidiaries shall be responsible or liable for misuse of the information contained herein.

Mounting and Clearance

Various Stages in the Protective Screen Assembly

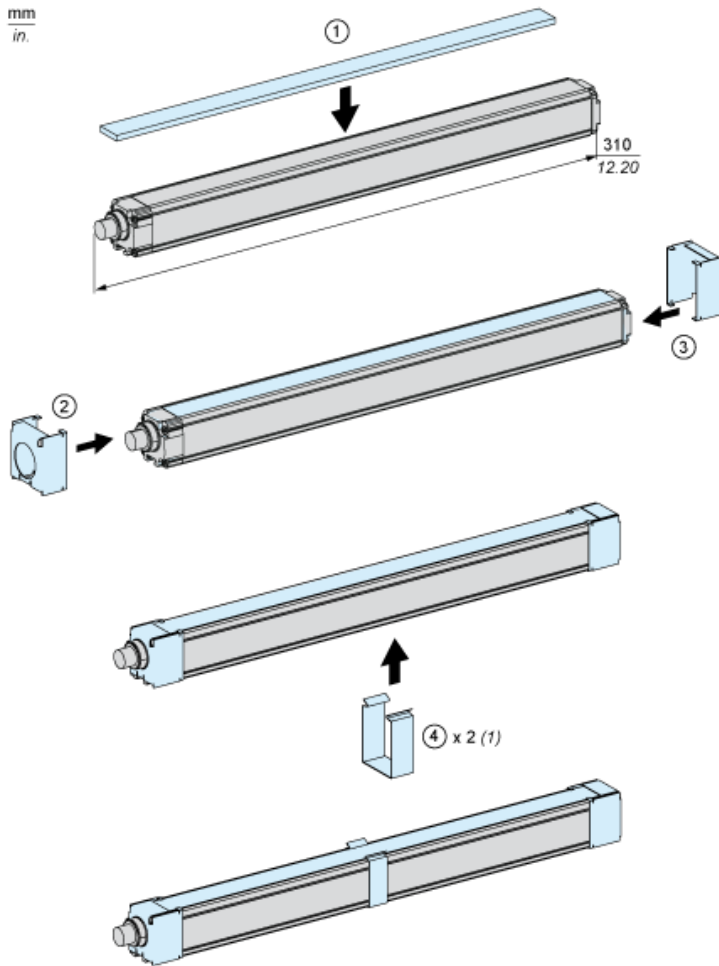

(1) Depending on the length