

**SV-SMT 7.62IT/04/90MSF3 2.6SN BK BX**
**Weidmüller Interface GmbH & Co. KG**

Klingenbergstraße 26

D-32758 Detmold

Germany

www.weidmueller.com



Similar to illustration

**OMNIMATE Power for IT networks – scalable to 50 kVA**
**Tailor-made solutions for special requirements**

More standard-compliance means fewer compromises: OMNIMATE Power for IT networks has integrated features incorporated as standard across the range. This makes the design-in and approvals process simpler and makes them safer and more reliable in operation.

Results for the application and advantages for the user: unlimited use in 400-V IT systems and touch safety according to IEC 61800-5-1 (+ 5.5 mm). The self-snapping one-handed safety flange enables intuitive and safe usage. Operational reliability is guaranteed by the automatic interlock feature during the plug-in process. In conclusion: You need no additional device covering. The application-oriented design means that no compromises are necessary during the approval process.

**General ordering data**

Version	PCB plug-in connector, male header, Middle screw flange, THT/THR solder connection, 7.62 mm, Number of poles: 4, 90°, Solder pin length (l): 2.6 mm, tinned, black, Box
Order No.	<a href="#">2499840000</a>
Type	SV-SMT 7.62IT/04/90MSF3 2.6SN BK BX
GTIN (EAN)	4050118513264
Qty.	48 pc(s).
Product data	IEC: 1000 V / 41 A UL: 300 V / 40.5 A
Packaging	Box

## SV-SMT 7.62IT/04/90MSF3 2.6SN BK BX

Weidmüller Interface GmbH &amp; Co. KG

Klingenbergstraße 26

D-32758 Detmold

Germany

www.weidmueller.com

## Technical data

## Dimensions and weights

Depth	28.3 mm	Depth (inches)	1.114 inch
Height of lowest version	11.4 mm	Net weight	8.8 g

## System specifications

Product family	OMNIMATE Power - series BV/SV 7.62HP	Type of connection	Board connection
Mounting onto the PCB	THT/THR solder connection	Pitch in mm (P)	7.62 mm
Pitch in inches (P)	0.3 inch	Outgoing elbow	90°
Number of poles	4	Number of solder pins per pole	2
Solder pin length (l)	2.6 mm	Solder pin length tolerance	+0.1 / -0.3 mm
Solder pin dimensions	0.8 x 1.0 mm	Solder eyelet hole diameter (D)	1.4 mm
Solder eyelet hole diameter tolerance (D)+	0,1 mm	L1 in mm	30.48 mm
L1 in inches	1.2 inch	Number of rows	1
Pin series quantity	1	Touch-safe protection acc. to DIN VDE 57 106	safe to back of hand above the printed circuit board
Touch-safe protection acc. to DIN VDE 0470	IP 20	Volume resistance	2.00 mΩ
Tightening torque for screw flange, min.	0.2 Nm	Tightening torque for screw flange, max.	0.3 Nm
Plugging cycles	25	Plugging force/pole, max.	12 N
Pulling force/pole, max.	7 N		

## Material data

Insulating material	PA GF HT3	Colour	black
Colour chart (similar)	RAL 9011	Insulating material group	I
Comparative Tracking Index (CTI)	≥ 600	Insulation strength	≥ 10 <sup>8</sup> Ω
Moisture Level (MSL)	3	UL 94 flammability rating	V-0
Contact material	Copper alloy	Contact surface	tinned
Layer structure of solder connection	1...3 μm Ni / 4...6 μm Sn matt	Layer structure of plug contact	1...3 μm Ni / 4...6 μm Sn matt
Storage temperature, min.	-40 °C	Storage temperature, max.	70 °C
Operating temperature, min.	-50 °C	Operating temperature, max.	130 °C
Temperature range, installation, min.	-25 °C	Temperature range, installation, max.	130 °C

## Rated data acc. to IEC

tested acc. to standard	IEC 60664-1, IEC 61984	Rated current, min. number of poles (Tu=20°C)	41 A
Rated current, max. number of poles (Tu=20°C)	41 A	Rated current, min. number of poles (Tu=40°C)	41 A
Rated current, max. number of poles (Tu=40°C)	41 A	Rated voltage for surge voltage class / pollution degree II/2	1,000 V
Rated voltage for surge voltage class / pollution degree III/2	630 V	Rated voltage for surge voltage class / pollution degree III/3	630 V
Rated impulse voltage for surge voltage class/ pollution degree II/2	6 kV	Rated impulse voltage for surge voltage class/ pollution degree III/2	6 kV
Rated impulse voltage for surge voltage class/ contamination degree III/3	6 kV	Short-time withstand current resistance	3 x 1s with 420 A

## SV-SMT 7.62IT/04/90MSF3 2.6SN BK BX

**Weidmüller Interface GmbH & Co. KG**  
 Klingenbergstraße 26  
 D-32758 Detmold  
 Germany

www.weidmueller.com

## Technical data

## Rated data acc. to UL 1059

Institute (cURus)



Certificate No. (cURus)

E60693

Rated voltage (Use group B / UL 1059)	300 V	Rated voltage (Use group C / UL 1059)	300 V
Rated voltage (Use group D / UL 1059)	300 V	Rated current (Use group B / UL 1059)	40.5 A
Rated current (Use group C / UL 1059)	40.5 A	Rated current (Use group D / UL 1059)	10 A
Clearance distance, min.	6.9 mm	Creepage distance, min.	9.6 mm
Reference to approval values	Specifications are maximum values, details - see approval certificate.		

## Packing

Packaging	Box	VPE length	338 mm
VPE width	130 mm	VPE height	33 mm

## Classifications

ETIM 6.0	EC002637	ETIM 7.0	EC002637
ECLASS 9.0	27-44-04-02	ECLASS 9.1	27-44-04-02
ECLASS 10.0	27-44-04-02	ECLASS 11.0	27-46-02-01

## Important note

IPC conformity	Conformity: The products are developed, manufactured and delivered according international recognized standards and norms and comply with the assured properties in the data sheet resp. fulfill decorative properties in accordance with IPC-A-610 "Class 2". Further claims on the products can be evaluated on request.
Notes	<ul style="list-style-type: none"> <li>• Additional colours on request</li> <li>• Rated current related to rated cross-section &amp; min. No. of poles.</li> <li>• P on drawing = pitch</li> <li>• Rated data refer only to the component itself. Clearance and creepage distances to other components are to be designed in accordance with the relevant application standards.</li> <li>• Long term storage of the product with average temperature of 50 °C and average humidity 70%, 36 months</li> </ul>

## Approvals

Approvals



UL File Number Search E60693

## Downloads

Engineering Data	<a href="#">STEP</a>
Brochure/Catalogue	<a href="#">Catalogues in PDF-format</a>

Creation date April 15, 2021 10:50:06 PM CEST

Catalogue status 09.04.2021 / We reserve the right to make technical changes.

SV-SMT 7.62IT/04/90MSF3 2.6SN BK BX

Weidmüller Interface GmbH & Co. KG  
Klingenbergstraße 26  
D-32758 Detmold  
Germany

www.weidmueller.com

Drawings

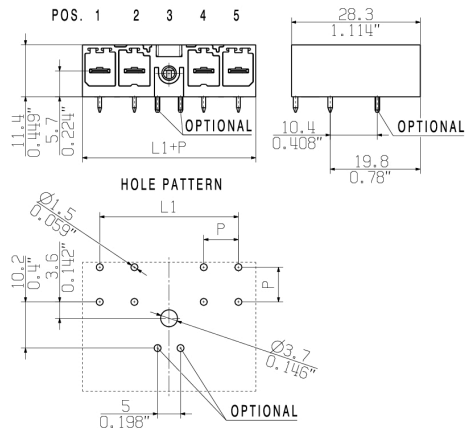

SV-SMT 7.62IT/04/270MF3

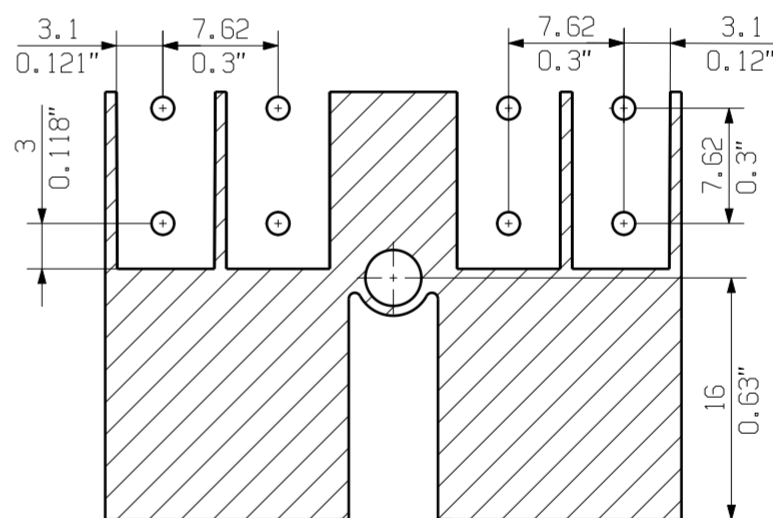
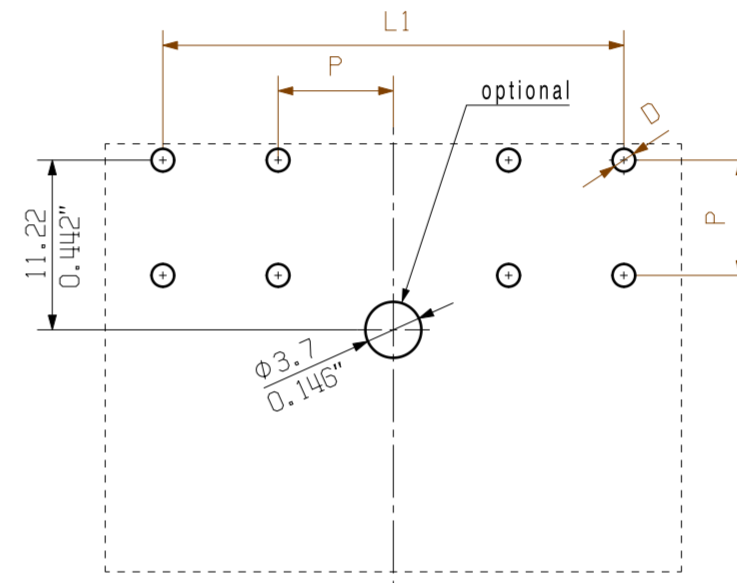
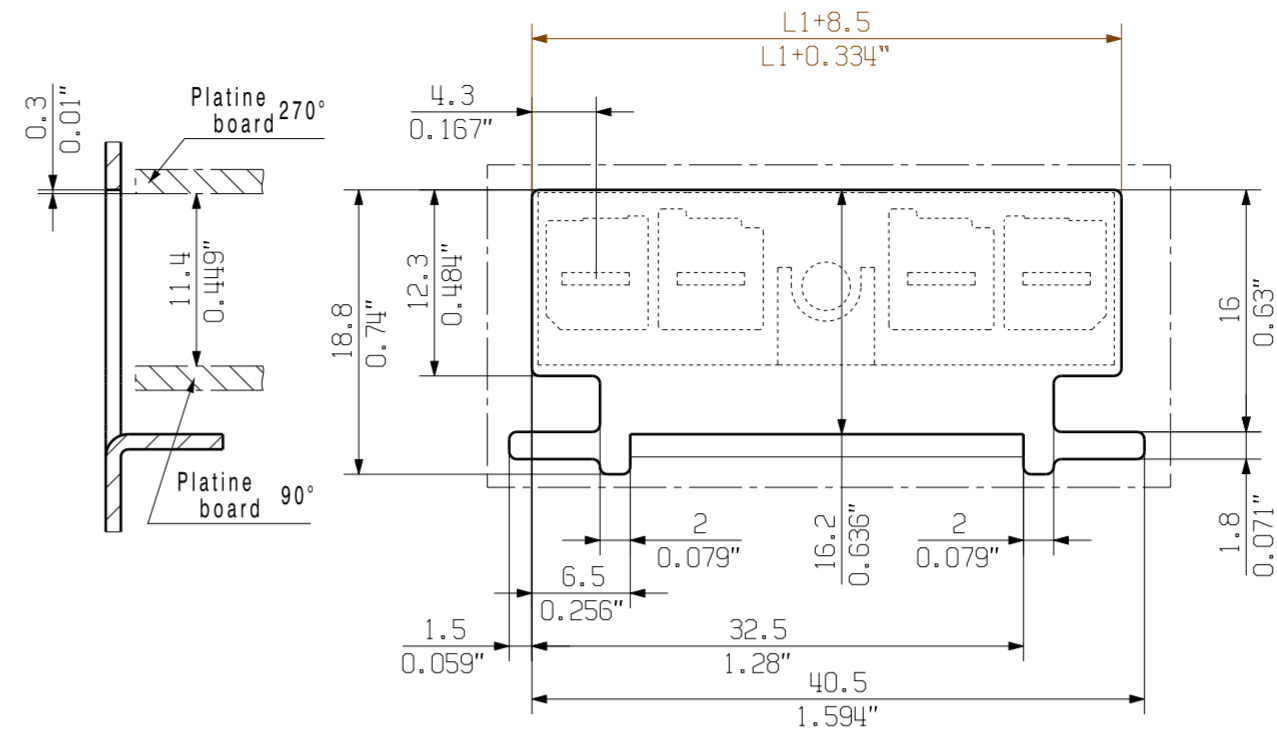
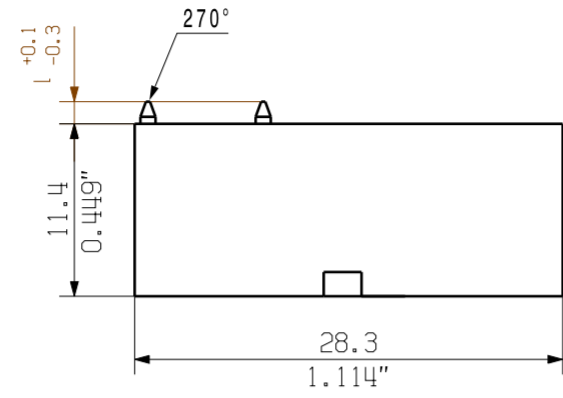
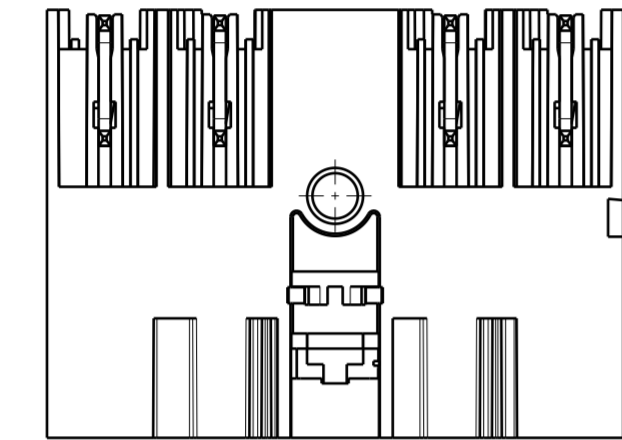
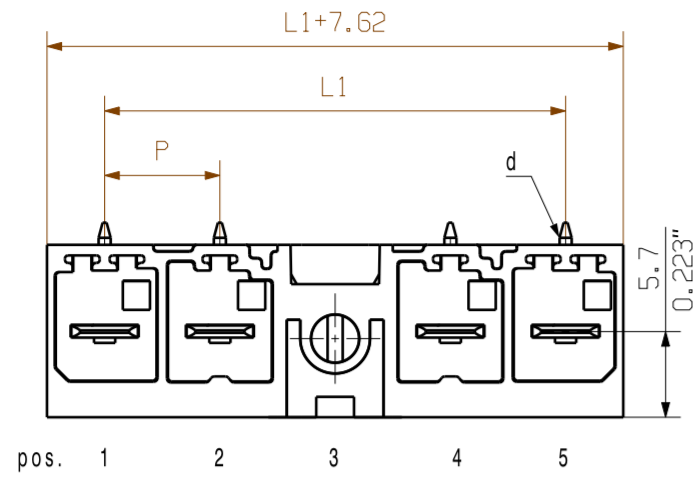

SV-SMT 7.62IT/04/270MSF3

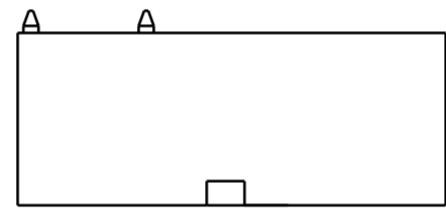
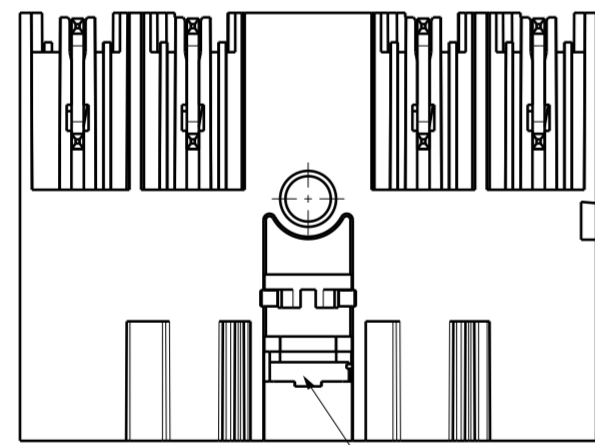
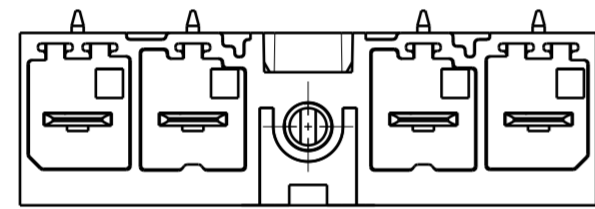

SV-SMT 7.62IT/04/270MF2



SV-SMT 7.62IT/04/270MSF2

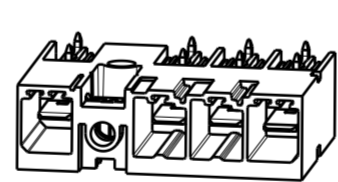

SV-SMT 7.62IT/04/270MF3

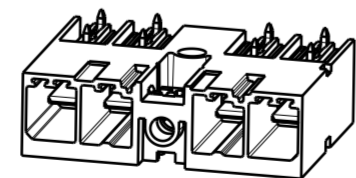

SV-SMT 7.62IT/04/270MSF3

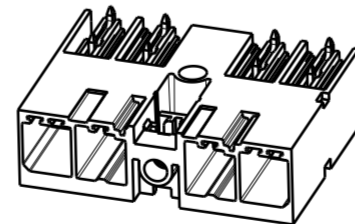

SV-SMT 7.62IT/04/270MF4

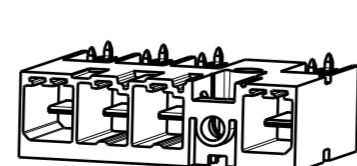

SV-SMT 7.62IT/04/270MSF4

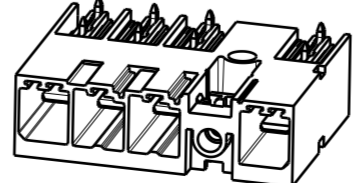

VKMU nur für MSF-Varianten / square nut only for MSF-variants

SO = ohne voreilenden Kontakt / without leading pin

D =  $0.1.4 + 0.1 / -0.05$   
d = 0.8x1.0

POL = Pol/pole  
PE = Voreilender Kontakt / leading pin  
P = Raster / pitch 7.62  
MF = Mittelflansch middle flange  
MSF = Mittelschraubflansch middle flange with screw

For the mounting of PCBs, it should be noted that the rated data relates only to the PCB components alone. The necessary creepage and clearance paths must be observed in connection with the respective applicant in accordance to IEC 664 / VDE 0110. The current-carrying capacity and pitch tolerance is to be determined according to DIN IEC 326 part 3 very fine.

Weidmüller PCB components are tested to the DIN EN 61984 standard, and are valid for its field of application. Provided that the components are used to the intended purpose, all requirements with respect to the occurring of electrical, mechanical, thermic and corrosive stress will be satisfied.

1.5
2.6
3.5
I
[mm]

GENERAL TOLERANCE: DIN ISO 2768-m

SV 7.62IT/05/...M(S)F5	5	38.10	1.50	Pol	Pol	Pol	Pol	MF	PE
SV 7.62IT/05/...M(S)F4				Pol	Pol	Pol	MF	Pol	Pol
SV 7.62IT/05/...M(S)F3				Pol	Pol	MF	Pol	Pol	Pol
SV 7.62IT/05/...M(S)F2				PE	MF	Pol	Pol	Pol	Pol
SV 7.62IT/04/...M(S)F4	4	30.48	1.20	Pol	Pol	Pol	MF	PE	
SV 7.62IT/04/...M(S)F3				Pol	Pol	MF	Pol	Pol	
SV 7.62IT/04/...M(S)F2				PE	MF	Pol	Pol	Pol	
SV 7.62IT/03/...M(S)F3	3	22.86	0.90	Pol	Pol	MF	PE		
SV 7.62IT/03/...M(S)F2				PE	MF	Pol	Pol		
SV 7.62IT/02/...M(S)F2 SO	2	15.24	0.60	Pol	MF	Pol			
description	no of poles	L1 [mm]	L1 [inch]	position MF					

ECO0002212	Prim PLM Part No.: 225880	Prim ERP Part No.: 2499550000
First Issue Date 14.11.2016	Max. nos.	<b>Weidmüller</b>
Date	Modification	
Drawn 30.08.2019 Helis, Maria	Date	63450
Responsible Döhner, Karl	Name	
Approved 09.10.2019 Lang, Thomas	Date	SV-SMT 7.62HP/IT/.. /90/270... STISTLEISTE MALE HEADER
Drawings Assembly	Size: A2	
Scale: 2:1	Product file: 7407 BLF 7.50HP	Sheet 16 of 17 sheets

The reproduction, distribution and utilization of this document as well as the communication of its contents to others without explicit authorization is prohibited. Offenders will be held liable for the payment of damages. Weidmüller exclusively reserves the right to file for patents, utility models or designs. © Weidmüller Interface GmbH & Co. KG

## Recommended wave soldering profiles

**Weidmüller Interface GmbH & Co. KG**  
 Klängenbergstraße 16  
 D-32758 Detmold  
 Germany  
 Fon: +49 5231 14-0  
 Fax: +49 5231 14-292083  
 www.weidmueller.com

### Single Wave:



### Double Wave:



### Wave soldering profiles

Wired connection elements should be processed in accordance with the DIN EN 61760-1 standard. We have included two recommendations for practical wave soldering profiles, with which Weidmüller PCB terminals and connectors are qualified.

When choosing a suitable profile for your application, the following factors also need to be considered:

- PCB thickness
- Proportion of Cu in the layers
- Single/double-sided assembly
- Product range
- Heating and cooling rates

The single and double wave profiles each indicate the recommended operating range, including the maximum soldering temperature of 260°C. In practice, the maximum soldering temperature is quite often well below the above maximum profile.

## Recommended reflow soldering profile

**Weidmüller Interface GmbH & Co. KG**  
 Klingenbergstraße 16  
 D-32758 Detmold  
 Germany  
 Fon: +49 5231 14-0  
 Fax: +49 5231 14-292083  
 www.weidmueller.com



### Reflow soldering profile

The perfect soldering profile for SMT Surface Mount Technology is one the most exiting question in SMT production. But there are more than one correct answer: The diagram of temperature-on-time is related to processing features of solder paste and to maximum load of components.

We have to consider the following parameters:

- Time for pre heating
- Maximum temperature
- Time above melting point
- Time for cooling
- Maximum heating rate
- Maximum cooling rate

We recommend a typical solder profile with associated process limits. With preheating components and board are prepared smoothly for the solder phase. Heating rate is typically  $\leq +3\text{K/s}$ . In parallel the solder paste is ‚activated‘. The time above melting point of 217°C the paste gets liquid and components and boards begin to connect. The maximum temperature of 245°C to 254°C should stay between 10 and 40 seconds. In the cooling phase at  $\geq -6\text{K/s}$  solder is cured. Board and components cool down while avoiding cold cracks.