

BVFL 7.62HP/02/180MF2 SN BK BX
Weidmüller Interface GmbH & Co. KG

Klingenbergstraße 26

D-32758 Detmold

Germany

www.weidmueller.com

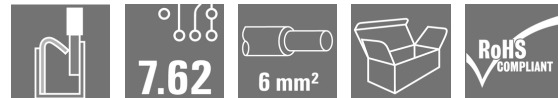
Product image

Similar to illustration

180° female plug with PUSH IN connection system with adjustable actuator (pusher) for field wiring 6 mm² in a 7.62 pitch. Meets the requirements of UL 1059 600 V Class C ad IEC 61800-5-1. Also ideal as a touch-safe solution for the power output. The self-locking middle flange which can optionally also be screwed, reduces the space requirements by one pitch width in comparison with conventional solutions. Variants: without flange, external flange, middle flange with snap-on mechanism and optionally additional screw mount

General ordering data

Version	PCB plug-in connector, female plug, 7.62 mm, Number of poles: 2, 180°, PUSH IN with actuator, Clamping range, max. : 6 mm ² , Box
Order No.	2549300000
Type	BVFL 7.62HP/02/180MF2 SN BK BX
GTIN (EAN)	4050118558739
Qty.	84 pc(s).
Product data	IEC: 1000 V / 41 A / 0.5 - 6 mm ² UL: 600 V / 39 A / AWG 24 - AWG 8
Packaging	Box

Creation date March 29, 2021 7:14:44 PM CEST

BVFL 7.62HP/02/180MF2 SN BK BX
Weidmüller Interface GmbH & Co. KG

Klingenbergstraße 26

D-32758 Detmold

Germany

www.weidmueller.com

Technical data
Dimensions and weights

Depth	52.1 mm	Depth (inches)	2.051 inch
Height	20.6 mm	Height (inches)	0.811 inch
Net weight	14.363 g		

System Parameters

Product family	OMNIMATE Power - series BV/SV 7.62HP	Type of connection	Field connection
Wire connection method	PUSH IN with actuator	Pitch in mm (P)	7.62 mm
Pitch in inches (P)	0.3 inch	Conductor outlet direction	180°
Number of poles	2	L1 in mm	15.24 mm
L1 in inches	0.6 inch	Number of rows	1
Pin series quantity	1	Rated cross-section	6 mm ²
Touch-safe protection acc. to DIN VDE 57 106	Safe from finger touch	Touch-safe protection acc. to DIN VDE 0470	IP 20
Volume resistance	4.50 mΩ	Can be coded	Yes
Stripping length	12 mm	Screwdriver blade	0.6 x 3.5
Plugging cycles	25		

Material data

Insulating material	PA GF	Colour	black
Colour chart (similar)	RAL 9011	Insulating material group	II
Comparative Tracking Index (CTI)	≥ 600	Insulation strength	≥ 10 ⁸ Ω
UL 94 flammability rating	V-0	Contact material	Copper alloy
Contact surface	tinned	Layer structure of plug contact	6...8 μm Sn glossy
Storage temperature, min.	-40 °C	Storage temperature, max.	70 °C
Operating temperature, min.	-50 °C	Operating temperature, max.	125 °C
Temperature range, installation, min.	-25 °C	Temperature range, installation, max.	125 °C

Conductors suitable for connection

Clamping range, min.	0.5 mm ²
Clamping range, max.	6 mm ²
Solid, min. H05(07) V-U	0.5 mm ²
Solid, max. H05(07) V-U	6 mm ²
Flexible, min. H05(07) V-K	0.5 mm ²
Flexible, max. H05(07) V-K	6 mm ²
w. plastic collar ferrule, DIN 46228 pt 4, 0.5 mm ² min.	
w. plastic collar ferrule, DIN 46228 pt 4, 6 mm ² max.	
w. wire end ferrule, DIN 46228 pt 1, min.	0.5 mm ²
w. wire end ferrule, DIN 46228 pt 1, max.	6 mm ²

BVFL 7.62HP/02/180MF2 SN BK BX
Weidmüller Interface GmbH & Co. KG

Klingenbergstraße 26

D-32758 Detmold

Germany

www.weidmueller.com

Technical data

Clampable conductor	Cross-section for conductor connection	Type	fine-wired
		nominal	0.5 mm ²
wire end ferrule	Stripping length	nominal	14 mm
		Recommended wire-end ferrule	H0.5/12 OR
Cross-section for conductor connection	Type	fine-wired	
		nominal	0.75 mm ²
wire end ferrule	Stripping length	nominal	14 mm
		Recommended wire-end ferrule	H0.75/18 W
Cross-section for conductor connection	Type	fine-wired	
		nominal	1 mm ²
wire end ferrule	Stripping length	nominal	15 mm
		Recommended wire-end ferrule	H1.0/18 GE
Cross-section for conductor connection	Type	fine-wired	
		nominal	1.5 mm ²
wire end ferrule	Stripping length	nominal	12 mm
		Recommended wire-end ferrule	H1.5/12
Cross-section for conductor connection	Type	fine-wired	
		nominal	1.5 mm ²
wire end ferrule	Stripping length	nominal	15 mm
		Recommended wire-end ferrule	H1.5/18D SW
Cross-section for conductor connection	Type	fine-wired	
		nominal	2.5 mm ²
wire end ferrule	Stripping length	nominal	12 mm
		Recommended wire-end ferrule	H2.5/12
Cross-section for conductor connection	Type	fine-wired	
		nominal	4 mm ²
wire end ferrule	Stripping length	nominal	14 mm
		Recommended wire-end ferrule	H2.5/19D BL
Cross-section for conductor connection	Type	fine-wired	
		nominal	4 mm ²
wire end ferrule	Stripping length	nominal	12 mm
		Recommended wire-end ferrule	H4.0/12
Cross-section for conductor connection	Type	fine-wired	
		nominal	6 mm ²
wire end ferrule	Stripping length	nominal	14 mm
		Recommended wire-end ferrule	H4.0/20D GR
Cross-section for conductor connection	Type	fine-wired	
		nominal	6 mm ²
wire end ferrule	Stripping length	nominal	12 mm
		Recommended wire-end ferrule	H6.0/12
Cross-section for conductor connection	Type	fine-wired	
		nominal	6 mm ²
wire end ferrule	Stripping length	nominal	14 mm
		Recommended wire-end ferrule	H6.0/20 SW

Reference text

The outside diameter of the plastic collar should not be larger than the pitch (P). Length of ferrules is to be chosen depending on the product and the rated voltage.

BVFL 7.62HP/02/180MF2 SN BK BX
Weidmüller Interface GmbH & Co. KG

Klingenbergstraße 26

D-32758 Detmold

Germany

www.weidmueller.com

Technical data
Rated data acc. to IEC

tested acc. to standard	IEC 60664-1, IEC 61984	Rated current, min. number of poles (Tu=20°C)	41 A
Rated current, max. number of poles (Tu=20°C)	41 A	Rated current, min. number of poles (Tu=40°C)	41 A
Rated current, max. number of poles (Tu=40°C)	38 A	Rated voltage for surge voltage class / pollution degree II/2	1,000 V
Rated voltage for surge voltage class / pollution degree III/2	1,000 V	Rated voltage for surge voltage class / pollution degree III/3	800 V
Rated impulse voltage for surge voltage class/ pollution degree II/2	6 kV	Rated impulse voltage for surge voltage class/ pollution degree III/2	8 kV
Rated impulse voltage for surge voltage class/ contamination degree III/3	8 kV	Short-time withstand current resistance	3 x 1s with 420 A

Rated data acc. to CSA

Rated voltage (Use group B / CSA)	600 V	Rated voltage (Use group C / CSA)	600 V
Rated voltage (Use group D / CSA)	600 V	Rated current (Use group B / CSA)	33 A
Rated current (Use group C / CSA)	33 A	Rated current (Use group D / CSA)	5 A
Wire cross-section, AWG, min.	AWG 24	Wire cross-section, AWG, max.	AWG 8

Rated data acc. to UL 1059

Rated voltage (Use group B / UL 1059)	600 V	Rated voltage (Use group C / UL 1059)	600 V
Rated voltage (Use group D / UL 1059)	600 V	Rated current (Use group B / UL 1059)	39 A
Rated current (Use group C / UL 1059)	39 A	Rated current (Use group D / UL 1059)	5 A
Wire cross-section, AWG, min.	AWG 24	Wire cross-section, AWG, max.	AWG 8

Packing

Packaging	Box	VPE length	350 mm
VPE width	135 mm	VPE height	58 mm

Classifications

ETIM 6.0	EC002638	ETIM 7.0	EC002638
ECLASS 9.0	27-44-03-09	ECLASS 9.1	27-44-03-09
ECLASS 10.0	27-44-03-09	ECLASS 11.0	27-46-02-02

BVFL 7.62HP/02/180MF2 SN BK BX

Weidmüller Interface GmbH & Co. KG
 Klingenbergstraße 26
 D-32758 Detmold
 Germany

www.weidmueller.com

Technical data
Important note

IPC conformity	Conformity: The products are developed, manufactured and delivered according international recognized standards and norms and comply with the assured properties in the data sheet resp. fulfill decorative properties in accordance with IPC-A-610 "Class 2". Further claims on the products can be evaluated on request.
Notes	<ul style="list-style-type: none"> • Additional colours on request • Wire end ferrule with plastic collar to DIN 46228/4 • Wire end ferrule without plastic collar to DIN 46228/1 • P on drawing = pitch • Rated data refer only to the component itself. Clearance and creepage distances to other components are to be designed in accordance with the relevant application standards. • Additional pole combinations on request • Long term storage of the product with average temperature of 50 °C and average humidity 70%, 36 months

Approvals

ROHS	Conform
------	---------

Downloads

Product Change Notification	EN - Change of isolation material DE - Werkstoffänderung Pusher
User Documentation	Operating Instruction BVFL QR-Code product handling video

BVFL 7.62HP/02/180MF2 SN BK BX

Weidmüller Interface GmbH & Co. KG
 Klingenbergstraße 26
 D-32758 Detmold
 Germany

www.weidmueller.com

Drawings

Dimensional drawing

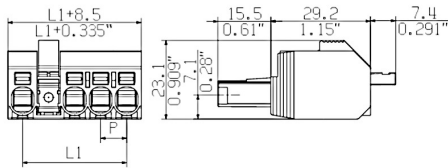

Similar to illustration

Connection diagram

6	M(S)F6	o	o	o	o	o	X	o
6	M(S)F5	o	o	o	o	X	o	o
6	M(S)F4	o	o	o	X	o	o	o
6	M(S)F3	o	o	X	o	o	o	o
6	M(S)F2	o	X	o	o	o	o	o
5	M(S)F5	o	o	o	o	X	o	o
5	M(S)F4	o	o	o	X	o	o	o
5	M(S)F3	o	o	X	o	o	o	o
5	M(S)F2	o	X	o	o	o	o	o
4	M(S)F4	o	o	o	X	o	o	o
4	M(S)F3	o	o	X	o	o	o	o
4	M(S)F2	o	X	o	o	o	o	o
3	M(S)F3	o	o	X	o	o	o	o
3	M(S)F2	o	X	o	o	o	o	o
2	M(S)F2	o	X	o	o	o	o	o
NO OF POLES	X = MIDDLE FLANGE POSITION	1	2	3	4	5	6	7

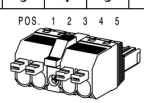

Graph

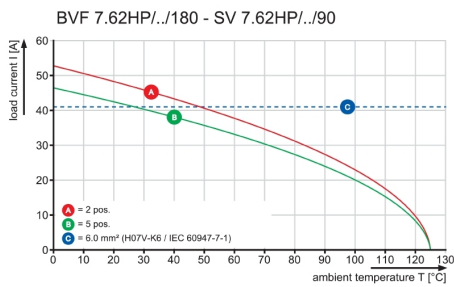

Graph

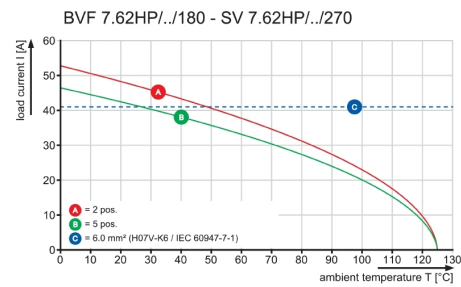

Graph

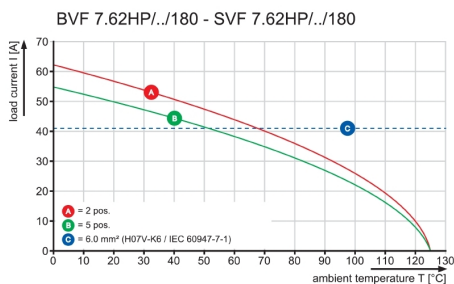

Product benefits



Secure connection of small conductors
PUSH IN WIRE READY

BVFL 7.62HP/02/180MF2 SN BK BX

Weidmüller Interface GmbH & Co. KG
Klingenbergstraße 26
D-32758 Detmold
Germany

Drawings

www.weidmueller.com

Product benefits



Installation without tools
Outlet direction: 90° und 180°

WEITERGABE SOWIE VERVIELFÄLTIGUNG DIESES DOKUMENTS, VERWERTUNG UND MITTEILUNG SEINES INHALTS SIND VERBOTEN, SOWEIT NICHT AUSDRUECKLICH GESTATTET.
 ZUWIDERHANDLUNGEN VERPFLICHTEN ZU SCHADENERSATZ. ALLE RECHTE FUER DEN FALL DER PATENT-, GEBRAUCHSMUSTER-, ODER GESCHMACKSMUSTERREINTRAGUNG VORBEHALTEN.
 THE REPRODUCTION, DISTRIBUTION AND UTILIZATION OF THIS DOCUMENT AS WELL AS THE COMMUNICATION OF ITS CONTENTS TO OTHERS WITHOUT EXPLICIT AUTHORIZATION IS PROHIBITED.
 OFFENDERS WILL BE HELD LIABLE FOR THE PAYMENT OF DAMAGES. WEIDMUELLER EXCLUSIVELY RESERVES THE RIGHT TO FILE FOR PATENTS, UTILITY MODELS OR DESIGNS.
 © WEIDMUELLER INTERFACE GmbH & Co.KG

SHOWN: BVFL 7.62HP/04/180



M 1:1



SHOWN: BVFL 7.62HP/04/180(S)F

DIE DEUTSCHE VERSION IST VERBINDLICH
THE GERMAN VERSION IS BINDING

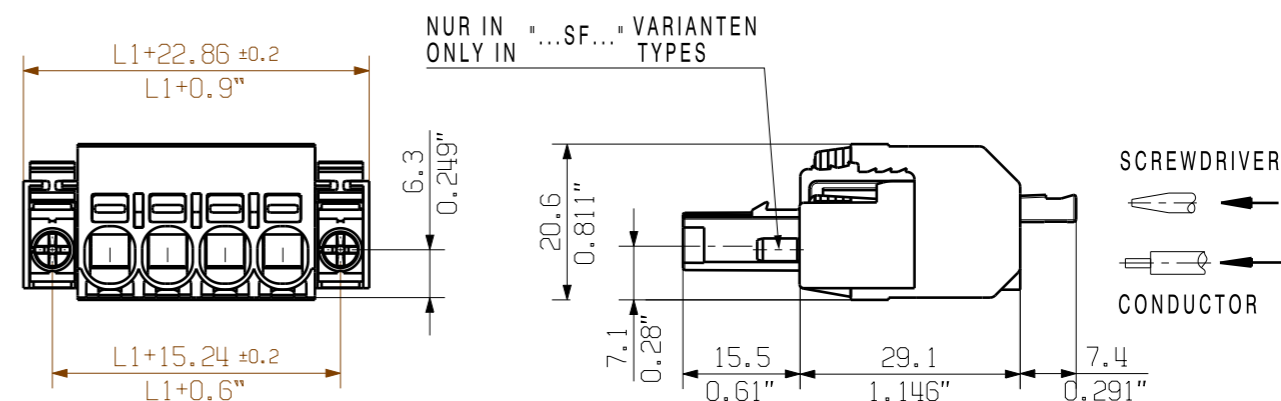

M 1:1



SHOWN: BVFL 7.62HP/04/180M(S)F

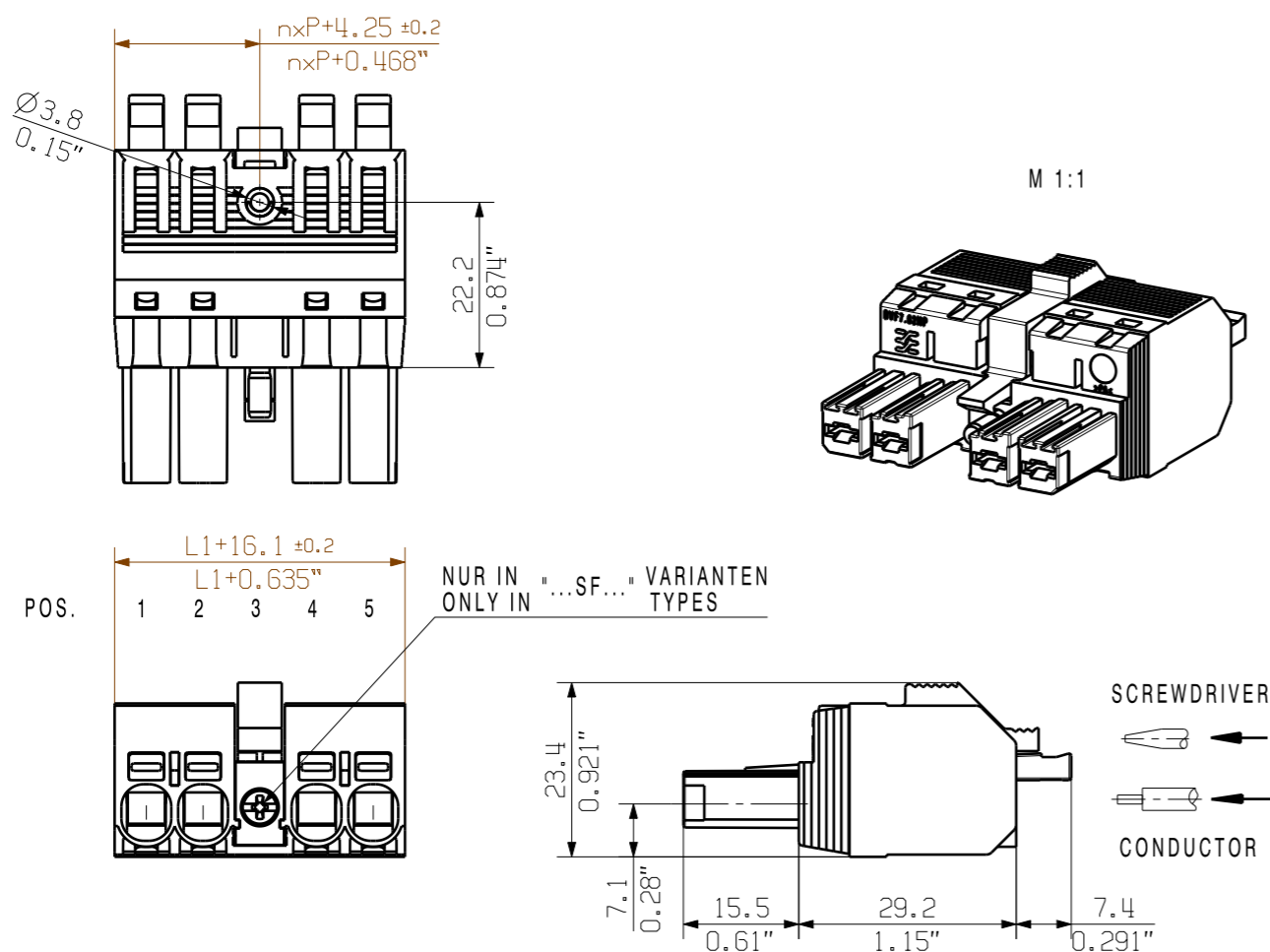

M 1:1

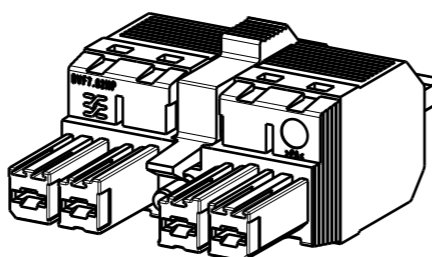

F= Flansch / flange
 SF=Schraubflansch / screw flange
 MF=Mittelflansch / middle flange
 MSF=Mittelschraubflansch / middle screw flange
 P= Raster / pitch
 n= Polzahl/no of poles

6 M(S)F 4	P	P	P	M(S)F	P	P	P
5 M(S)F 4	P	P	P	M(S)F	P	P	
5 M(S)F 3	P	P	M(S)F	P	P	P	
4 M(S)F 4	P	P	P	M(S)F	P		
4 M(S)F 3	P	P	M(S)F	P	P		
3 M(S)F 3	P	P	M(S)F	P			
3 M(S)F 2	P	M(S)F	P	P			
2 M(S)F 2	P	M(S)F	P				
POS.	1	2	3	4	5	6	7

For the mounting of PCBs, it should be noted that the rated data relates only to the PCB components alone. The necessary creepage and clearance paths must be observed in connection with the respective applicant in accordance to IEC 664 / VDE 0110. The current-carrying capacity and pitch tolerance is to be determined according to DIN IEC 326 part 3 very fine.

Weidmüller PCB components are tested to the DIN EN 61984 standard, and are valid for its field of application. Provided that the components are used to the intended purpose, all requirements with respect to the occurring of electrical, mechanical, thermic and corrosive stress will be satisfied.

7	45,72	1,8
6	38,10	1,5
5	30,48	1,2
4	22,86	0,9
3	15,24	0,6
2	7,62	0,3
POLE NO OF POLES	L1 (mm)	L1 (Inch)

RoHS COMPLIANT DIN ISO 2768-m
 97120/0 18.08.17 HELIS_MA 00
MODIFICATION
Weidmüller
C 60714 03
 DRAWING NO. ISSUE NO.
 SHEET 01 OF 01 SHEETS
BVFL 7.62HP/.../180...
 BUCHSENSTECKER FEMALE PLUG
 SCALE: 2:1
 SUPERSEDES: .
 DATE NAME
 DRAWN 23.09.2014 HELIS_MA
 RESPONSIBLE KRUG_M
 CHECKED 18.08.2017 HELIS_MA
 APPROVED LANG_T
 PRODUCT FILE: BVF 7.62HP 7390