



# CLV630-0000F0

CLV63x

FIXED MOUNT BAR CODE SCANNERS

**SICK**  
Sensor Intelligence.



### Ordering information

Type	Part no.
CLV630-0000F0	1051733

Other models and accessories → [www.sick.com/CLV63x](http://www.sick.com/CLV63x)



### Detailed technical data

#### Features

<b>Version</b>	Long Range
<b>Connection type</b>	Cable
<b>Reading field</b>	Front
<b>Scanning method</b>	Line scanner
<b>Optical focus</b>	Fixed focus
<b>Light source</b>	Light spot Laser, Visible, Red, 655 nm
<b>Light spot</b>	Circular
<b>Laser class</b>	2 (IEC 60825-1:2014, EN 60825-1:2014)
<b>Aperture angle</b>	≤ 50°
<b>Scanning frequency</b>	400 Hz ... 1,200 Hz
<b>Code resolution</b>	0.35 mm ... 1 mm
<b>Reading distance</b>	60 mm ... 735 mm <sup>1)</sup>
<b>Heating</b>	✓

<sup>1)</sup> For details see reading field diagram.

#### Mechanics/electronics

<b>Connection type</b>	1 x 15-pin D-Sub HD male connector (0.9 m) 1 x cable, open-ended, 3-wire (2 m)
<b>Supply voltage</b>	≤ 24 V DC, ± 10 %
<b>Power consumption</b>	40 W
<b>Housing</b>	Aluminum die cast
<b>Housing color</b>	Light blue (RAL 5012)
<b>Front screen</b>	Glass
<b>Enclosure rating</b>	IP65 (EN 60529)
<b>Protection class</b>	III (EN 61140)
<b>Weight</b>	520 g, with connecting cable

<b>Dimensions (L x W x H)</b>	61 mm x 96 mm x 50 mm
<b>MTBF</b>	100,000 h

### Performance

<b>Readable code structures</b>	1D codes
<b>Bar code types</b>	All current code types, Code 39, Code 128, Code 93, Codabar, GS1-128 / EAN 128, UPC / GTIN / EAN, Interleaved 2 of 5, Pharmacode, GS1 DataBar, Telepen, MSI/Plessey
<b>Print ratio</b>	2:1 ... 3:1
<b>No. of codes per scan</b>	1 ... 20 (Standard decoder) 1 ... 6 (SMART decoder)
<b>No. of codes per reading interval</b>	1 ... 50 (auto-discriminating)
<b>No. of characters per reading interval</b>	5,000 500 (for multiplexer function in CAN operation)
<b>No. of multiple readings</b>	1 ... 99

### Interfaces

<b>PROFINET</b>	✓
Type of fieldbus integration	Optional over external fieldbus module CDF600-2
Function	PROFINET Single Port, PROFINET Dual Port
<b>EtherCAT</b>	✓
Type of fieldbus integration	Optional over external fieldbus module CDF600
<b>Serial</b>	✓, RS-232, RS-422, RS-485
Function	Host, AUX
Data transmission rate	2,400 Baud ... 115.2 kBaud, AUX: 57.6 kBaud (RS-232)
<b>CAN</b>	✓
Function	SICK CAN sensor network CSN (master/slave, multiplexer/server)
Data transmission rate	20 kbit/s ... 1 Mbit/s
<b>CANopen</b>	✓
Data transmission rate	20 kbit/s ... 1 Mbit/s
<b>PROFIBUS DP</b>	✓
Type of fieldbus integration	Optional over external fieldbus module CDF600-2
<b>DeviceNet™</b>	✓
Type of fieldbus integration	Optional, over external connection module CDM + CMF
<b>Digital inputs</b>	4 ("Sensor 1", "Sensor 2", 2 inputs via optional parameter storage CMC600 in CDB620/CDM420)
<b>Digital outputs</b>	4 ("Result 1", "Result 2", 2 outputs via optional parameter storage CMC600 in CDB620/CDM420)
<b>Reading pulse</b>	Digital inputs, non-powered, serial interface, auto pulse, CAN
<b>Optical indicators</b>	6 LEDs (Ready) , Result , laser , Data , CAN , LNK TX , Bar graph for displaying the reading rate percentage (10 LEDs)
<b>Acoustic indicators</b>	Beeper/buzzer (can be switched off, can be allocated as a result indication function)
<b>Control elements</b>	2 buttons (choose and start/stop functions)
<b>Configuration software</b>	SOPAS ET

<b>Memory card</b>	MicroSD memory card (flash card), optional
--------------------	--

Ambient data

<b>Electromagnetic compatibility (EMC)</b>	EN 61000-6-3 (2001-10) / EN 61000-6-2:2005
<b>Vibration resistance</b>	EN 60068-2-6 (1995)
<b>Ambient operating temperature</b>	-35 °C ... +35 °C
<b>Storage temperature</b>	-20 °C ... +70 °C
<b>Permissible relative humidity</b>	90 %, Non-condensing
<b>Ambient light immunity</b>	2,000 lx, on bar code
<b>Bar code print contrast (PCS)</b>	≥ 60 %

General notes

<b>Note on use</b>	For Ethernet connection please use an Ethernet version of CLV6xx
--------------------	--

Classifications

<b>ECl@ss 5.0</b>	27280102
<b>ECl@ss 5.1.4</b>	27280102
<b>ECl@ss 6.0</b>	27280102
<b>ECl@ss 6.2</b>	27280102
<b>ECl@ss 7.0</b>	27280102
<b>ECl@ss 8.0</b>	27280102
<b>ECl@ss 8.1</b>	27280102
<b>ECl@ss 9.0</b>	27280102
<b>ECl@ss 10.0</b>	27280102
<b>ECl@ss 11.0</b>	27280102
<b>ETIM 5.0</b>	EC002550
<b>ETIM 6.0</b>	EC002550
<b>ETIM 7.0</b>	EC002550
<b>UNSPSC 16.0901</b>	43211701

Dimensional drawing (Dimensions in mm (inch))

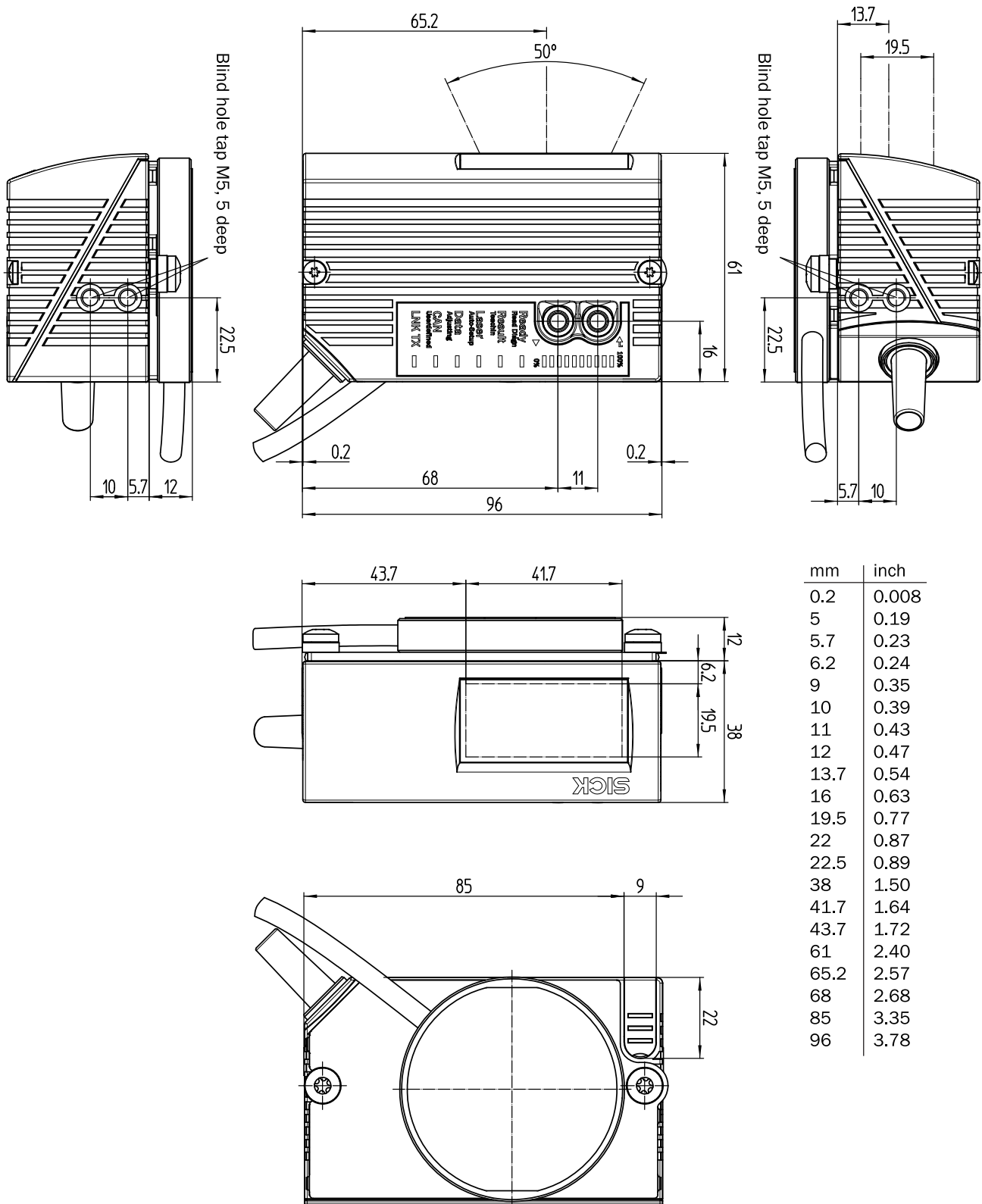

## Reading field diagram

Reading field height in mm (inch)

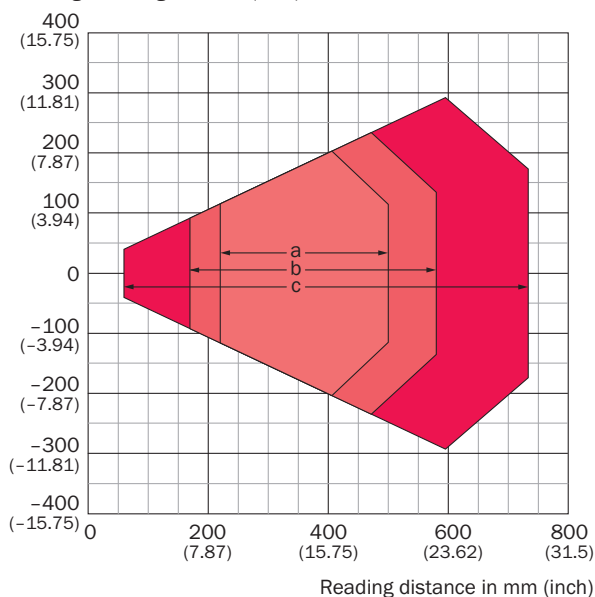





For devices with plastic reading window, the depth of field is reduced by approx. 10 %.



### Resolution

- a: 0.35 mm (13.8 mil)
- b: 0.50 mm (19.7 mil)
- c: 1.0 mm (39.4 mil)

## Recommended accessories

Other models and accessories → [www.sick.com/CLV63x](http://www.sick.com/CLV63x)

	Brief description	Type	Part no.
<b>Mounting brackets and plates</b>			
	Hanger-shaped mounting bracket, thermally isolated for use with heating devices, mounting hardware included	Mounting bracket	2050705
<b>Cloning module</b>			
	External parameter memory for integration in CDB620/CDB650/CDM42x	CMC600-101	1042259
<b>Modules</b>			
	Small connection module for one sensor, 4 cable glands, base for CMC600	CDB620-001	1042256
	Modular connection module for one sensor	CDM420-0001	1025362

	Brief description	Type	Part no.
Electronic modules			
	Additional board for connecting a bar code scanner with heater in combination with CDM-420	Additional board	2055071
Storage media			
	microSD memory card with 1 GB for industrial use	microSD memory card	4051366

## Recommended services

Additional services → [www.sick.com/CLV63x](http://www.sick.com/CLV63x)

	Type	Part no.
Performance check		
<ul style="list-style-type: none"> <li>• <b>Product area:</b> Fixed mount bar code scanners</li> <li>• <b>Range of services:</b> Inspection of defined functions, e.g., reading performance</li> <li>• <b>Travel expenses:</b> The prices do not include travel costs such as hotel, flight, travel time and expenses.</li> <li>• <b>Duration:</b> Additional work will be invoiced separately</li> </ul>	Performance check CLV4xx/CLV6xx	1682028
Product, system, and software training		
<ul style="list-style-type: none"> <li>• <b>Range of services:</b> SICK offers training courses for numerous target groups ranging from basic to expert levels, Training format and location can be worked out in collaboration with SICK</li> </ul>	Training for the CLV6 series	1612231
Warranty extensions		
<ul style="list-style-type: none"> <li>• <b>Product area:</b> Identification solutions, machine vision, Distance sensors, Detection and ranging solutions</li> <li>• <b>Range of services:</b> The services correspond to the scope of the statutory manufacturer warranty (SICK general terms and conditions of purchase)</li> <li>• <b>Duration:</b> Five-year warranty from delivery date.</li> </ul>	Extended warranty for a total of five years from delivery date	1680671
Commissioning		
<ul style="list-style-type: none"> <li>• <b>Product area:</b> Fixed mount bar code scanners</li> <li>• <b>Range of services:</b> Inspection of connection, fine adjustment, optimization of parameters of SICK product as well as tests, Setup of previously defined functions of reading configuration, code configuration, data processing and network, interfaces or inputs and outputs</li> <li>• <b>Travel expenses:</b> The prices do not include travel costs such as hotel, flight, travel time and expenses.</li> <li>• <b>Duration:</b> Additional work will be invoiced separately</li> </ul>	Commissioning CLV61x ... CLV64x	1681925

## SICK AT A GLANCE

SICK is one of the leading manufacturers of intelligent sensors and sensor solutions for industrial applications. A unique range of products and services creates the perfect basis for controlling processes securely and efficiently, protecting individuals from accidents and preventing damage to the environment.

We have extensive experience in a wide range of industries and understand their processes and requirements. With intelligent sensors, we can deliver exactly what our customers need. In application centers in Europe, Asia and North America, system solutions are tested and optimized in accordance with customer specifications. All this makes us a reliable supplier and development partner.

Comprehensive services complete our offering: SICK LifeTime Services provide support throughout the machine life cycle and ensure safety and productivity.

For us, that is “Sensor Intelligence.”

## WORLDWIDE PRESENCE:

Contacts and other locations –[www.sick.com](http://www.sick.com)