



IRL-P212E40

ZoneControl

MULTITASK PHOTOELECTRIC SENSORS

SICK
Sensor Intelligence.



Illustration may differ



Ordering information

| Type | Part no. |
|-------------|----------|
| IRL-P212E40 | 1085231 |

Other models and accessories → www.sick.com/ZoneControl

Detailed technical data

Features

| | |
|---------------------------------------|--|
| Actuator | Pneumatic, valve on board |
| Max. number of sensors | Approx. 30 ¹⁾ Approx. 50 ²⁾ |
| Logical principle of operation | Single accumulation |
| Type of Release | Single release, block (slug) release |
| Sensor/ detection principle | Photoelectric retro-reflective sensor |
| Dimensions (W x H x D) | 50 mm x 147.4 mm x 48.9 mm |
| Sensing range max. | 250 mm ... 1,500 mm |
| Sensing range | 250 mm ... 1,500 mm ³⁾ |
| Focus | 7° |
| Type of light | Visible red light |
| Light source | LED ⁴⁾ |
| Light spot size (distance) | Ø 20 mm (500 mm) |
| Angle of dispersion | 7° |
| Adjustment | Potentiometer, 9 turns |
| Special applications | ZoneControl |

¹⁾ When power from the end of the IR daisy chain.

²⁾ When power from center of the IR daisy chain.

³⁾ On reflective tape REF-7610-K.

⁴⁾ Average service life: 100,000 h at T_J = +25 °C.

Mechanics/electronics

| | |
|---|--|
| Supply voltage | 19.2 V DC ... 27.6 V DC ¹⁾ |
| Ripple | < 5 V _{pp} ²⁾ |
| Current consumption | 20 mA ³⁾ |
| Switching output | PNP |
| Signal voltage PNP HIGH/LOW | Approx. V _S - 0.5 V / 0 V |
| Output current I_{max.} | ≤ 100 mA |
| Response time | 2 ms |
| Switching frequency | 250 Hz |
| Connection type | Male connector M12, 4-pin |
| Connection type for daisy chain | Cable with receptacle, M12, 4-pin 2 m |
| Circuit protection | A ⁴⁾ C ⁵⁾ D ⁶⁾ |
| Protection class | III |
| Weight | 175 g |
| Housing material | Plastic, ABS |
| Enclosure rating | IP65 |
| Shock and vibration resistance | According to IEC 68 |
| Ambient operating temperature | -10 °C ... +55 °C |
| Ambient storage temperature | -40 °C ... +75 °C |
| UL File No. | NRKH.E189383 & NRKH7.E189383 |
| Medium for valves | Compressed air or neutral gases filtered, non-lubricated or lubricated |
| Design solenoid valve | 3/2-way valve |
| Mode of operation solenoid valve | Air to Drive (NC) |
| Connection type solenoid valve | Compressed air 2 x 8 mm diameter, output line 4 mm diameter |
| Coil ratings | 24 V DC 1 W |
| Air flow rate | Approx. 20 NI/min |
| Ventilation capacity | Approx. 130 NI/min |
| Operating pressure range | 2 bar ... 8 bar |

¹⁾ Limit values.

²⁾ May not exceed or fall below U_v tolerances.

³⁾ Without load and valve deenergized.

⁴⁾ A = V_S connections reverse-polarity protected.

⁵⁾ C = interference suppression.

⁶⁾ D = outputs overcurrent and short-circuit protected.

Safety-related parameters

| | |
|-------------------------|-------------|
| MTTF_D | 1,374 years |
| DC_{avg} | 0% |

Pneumatic

| | |
|--------------------------|--|
| Coil ratings | 24 V DC 1 W |
| Medium for valves | Compressed air or neutral gases filtered, non-lubricated or lubricated |

| | |
|---------------------------------------|---|
| Design solenoid valve | 3/2-way valve |
| Connection type solenoid valve | Compressed air 2 x 8 mm diameter, output line 4 mm diameter |
| Air flow rate | Approx. 20 NI/min |
| Ventilation capacity | Approx. 130 NI/min |
| Operating pressure range | 2 bar ... 8 bar |

Classifications

| | |
|-----------------------|----------|
| ECl@ss 5.0 | 27270902 |
| ECl@ss 5.1.4 | 27270902 |
| ECl@ss 6.0 | 27270902 |
| ECl@ss 6.2 | 27270902 |
| ECl@ss 7.0 | 27270902 |
| ECl@ss 8.0 | 27270902 |
| ECl@ss 8.1 | 27270902 |
| ECl@ss 9.0 | 27270902 |
| ECl@ss 10.0 | 27270902 |
| ECl@ss 11.0 | 27270902 |
| ETIM 5.0 | EC002717 |
| ETIM 6.0 | EC002717 |
| ETIM 7.0 | EC002717 |
| UNSPSC 16.0901 | 39121528 |

Connection diagram

Cd-264

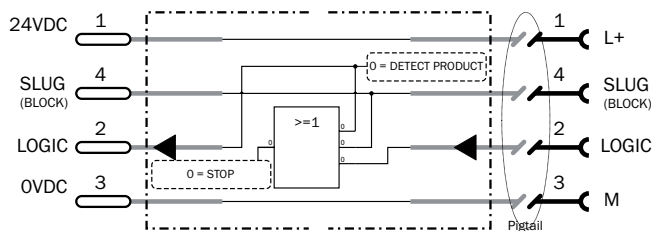

Characteristic curve

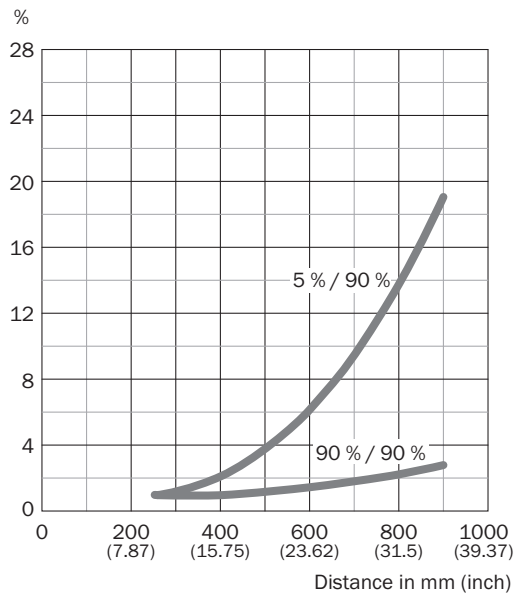

Light spot size

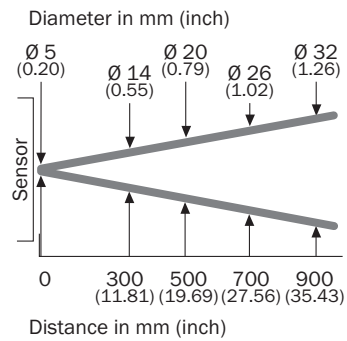

Sensing range diagram

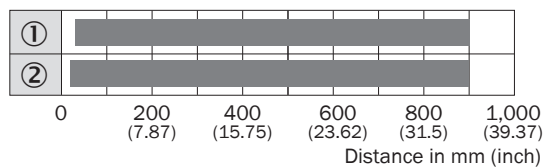

- Sensing range max.
- ① Sensing range on black, 5% remission
- ② Sensing range on white, 90% remission

Dimensional drawing (Dimensions in mm (inch))

IR, valve metric/imperial

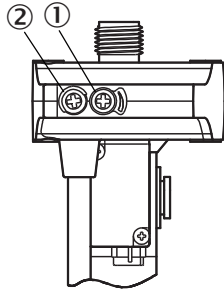

| Valve | A | B | C | D | E | F |
|------------|----------------|--------------|----------------|----------------|----------------|-----------------|
| A1x | 46.7 (1.84) | 18 (0.71) | 24.6 (0.97) | 59.9 (2.36) | 31.7 (1.25) | 151.9 (5.98) |
| E3x | 30.2 (1.19) | 22 (0.87) | 24.6 (0.97) | 49.9 (1.96) | 22.2 (0.87) | 135.4 (5.33) |
| E4x | 42.2 (1.66) | 18 (0.71) | 24.7 (0.97) | 50 (1.97) | 34.2 (1.35) | 147.4 (5.80) |
| E5x | 21.5 (0.85) | 22 (0.87) | 28.7 (1.13) | 50 (1.97) | 15.1 (0.59) | 125.3 (4.93) |



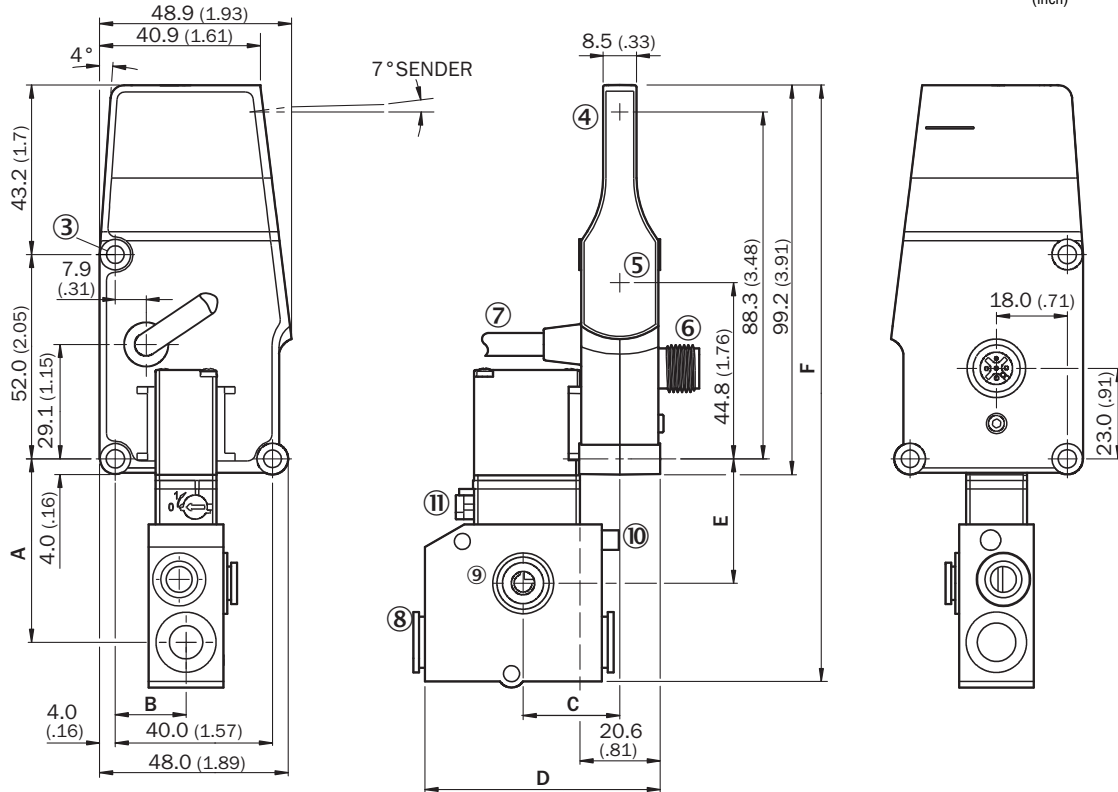

mm
(inch)



- ① Potentiometer
- ② LED
- ③ Fixing hole
- ④ Center of optical axis, sender
- ⑤ Center of optical axis, receiver
- ⑥ Male connector M12, 4-pin
- ⑦ Series connection, cable with female connector

Recommended accessories

Other models and accessories → www.sick.com/ZoneControl

| | Brief description | Type | Part no. |
|---|---|--------------------|----------|
| Mounting brackets and plates | | | |
|  | Mounting bracket, steel, zinc coated, mounting hardware included | BEF-WK-WTR | 2051786 |
|  | | BEF-WN-RT/IRT | 2074621 |
| Plug connectors and cables | | | |
|  | Head A: female connector, M12, 4-pin, straight, A-coded Head B: Flying leads Cable: Sensor/actuator cable, PVC, unshielded, 5 m | YF2A14-050VB3XLEAX | 2096235 |
|  | | | |

SICK AT A GLANCE

SICK is one of the leading manufacturers of intelligent sensors and sensor solutions for industrial applications. A unique range of products and services creates the perfect basis for controlling processes securely and efficiently, protecting individuals from accidents and preventing damage to the environment.

We have extensive experience in a wide range of industries and understand their processes and requirements. With intelligent sensors, we can deliver exactly what our customers need. In application centers in Europe, Asia and North America, system solutions are tested and optimized in accordance with customer specifications. All this makes us a reliable supplier and development partner.

Comprehensive services complete our offering: SICK LifeTime Services provide support throughout the machine life cycle and ensure safety and productivity.

For us, that is “Sensor Intelligence.”

WORLDWIDE PRESENCE:

Contacts and other locations –www.sick.com