

# DFS60S-BDOK01024

DFS60S Pro

SAFETY ENCODERS

**SICK**  
Sensor Intelligence.

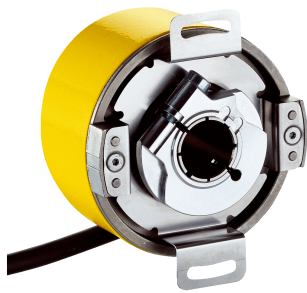

Illustration may differ



### Ordering information

Type	Part no.
DFS60S-BDOK01024	1069536

Other models and accessories → [www.sick.com/DFS60S\\_Pro](http://www.sick.com/DFS60S_Pro)

### Detailed technical data

#### Safety-related parameters

<b>Safety integrity level</b>	SIL2 (IEC 61508), SILCL2 (IEC 62061) <sup>1)</sup>
<b>Performance level</b>	PL d (EN ISO 13849) <sup>1)</sup>
<b>Category</b>	3 (EN ISO 13849)
<b>PFH<sub>D</sub>: Probability of dangerous failure per hour</b>	1.7 × 10 <sup>-8 2)</sup>
<b>T<sub>M</sub> (mission time)</b>	20 years (EN ISO 13849)
<b>Safety-related measuring step</b>	0.09°, Quadrature analysis
<b>Safety-related accuracy</b>	± 0.09°

<sup>1)</sup> For more detailed information on the exact configuration of your machine/unit, please consult your relevant SICK branch office.

<sup>2)</sup> The values displayed apply to a diagnostic degree of coverage of 99%, which must be achieved by the external drive system and 95 °C operating temperature.

#### Performance

<b>Sine/cosine periods per revolution</b>	1,024
<b>Measuring step</b>	0.3°, For interpolation of the sine/cosine signals with, e. g., 12 bits <sup>1)</sup>
<b>Initialization time</b>	50 ms <sup>2)</sup>
<b>Integral non-linearity</b>	Typ. ± 45 Winkelsekunden (without mechanical tension of the stator coupling)
<b>Differential non-linearity</b>	± 7 Winkelsekunden
<b>Reference signal, number</b>	1
<b>Reference signal, position</b>	90°, electronically, gated with Sinus and Cosinus

<sup>1)</sup> Not safety-related.

<sup>2)</sup> Valid signals can be read once this time has elapsed.

#### Electrical data

<b>Communication interface</b>	Incremental
--------------------------------	-------------

<sup>1)</sup> 1.0 V<sub>SS</sub> (differential).

<sup>2)</sup> The universal cable connection is positioned so that it can be laid in a radial or axial direction without any kinks. UL approval not available.

<sup>3)</sup> Short-circuit to another channel or GND permitted for max. 30 s. In the case of U<sub>S</sub> ≤ 12 V additional short-circuit to U<sub>S</sub> permitted for max. 30 s.

<b>Communication Interface detail</b>	Sin/Cos <sup>1)</sup>
<b>Connection type</b>	Cable, 8-wire, universal, 1.5 m <sup>2)</sup>
<b>Supply voltage</b>	4.5 V ... 32 V
<b>Maximum output frequency</b>	≤ 153.6 kHz
<b>Load resistance</b>	≥ 120 Ω
<b>Power consumption max. without load</b>	≤ 0.7 W
<b>Power consumption</b>	Without load
<b>Reverse polarity protection</b>	✓
<b>Protection class</b>	III (according to DIN EN 61140)
<b>Short-circuit protection</b>	✓ <sup>3)</sup>

<sup>1)</sup> 1.0 V<sub>SS</sub> (differential).

<sup>2)</sup> The universal cable connection is positioned so that it can be laid in a radial or axial direction without any kinks. UL approval not available.

<sup>3)</sup> Short-circuit to another channel or GND permitted for max. 30 s. In the case of U<sub>S</sub> ≤ 12 V additional short-circuit to U<sub>S</sub> permitted for max. 30 s.

## Mechanical data

<b>Mechanical design</b>	Blind hollow shaft with feather key groove
<b>Shaft diameter</b>	10 mm
<b>Shaft material</b>	Stainless steel
<b>Flange material</b>	Die-cast zinc
<b>Housing material</b>	Aluminum die cast
<b>Weight</b>	Approx. 0.25 kg <sup>1)</sup>
<b>Start up torque</b>	≤ 0.8 Ncm (at 20 °C)
<b>Operating torque</b>	≤ 0.6 Ncm (at 20 °C)
<b>Permissible movement static</b>	± 0.3 mm (radial) ± 0.5 mm (axial)
<b>Permissible movement dynamic</b>	± 0.05 mm (radial) ± 0.1 mm (axial)
<b>Max. angular acceleration</b>	≤ 500,000 rad/s <sup>2</sup>
<b>Operating speed</b>	6,000 min <sup>-1</sup> <sup>2)</sup>
<b>Moment of inertia of the rotor</b>	56 gcm <sup>2</sup>
<b>Bearing lifetime</b>	3.6 x 10 <sup>9</sup> revolutions <sup>3)</sup>

<sup>1)</sup> Relates to encoders with male connector.

<sup>2)</sup> Allow for self-heating of approx. 3.0 K per 1,000 rpm regarding the permissible operating temperature.

<sup>3)</sup> On maximum operating speed and temperature.

## Ambient data

<b>EMC</b>	According to EN 61000-6-2, EN 61000-6-3 and IEC 61326-3-1
<b>Enclosure rating</b>	IP65 (according to IEC 60529) <sup>1)</sup>
<b>Permissible relative humidity</b>	90 %, Condensation not permitted
<b>Operating temperature range</b>	-30 °C ... +85 °C <sup>2)</sup>
<b>Storage temperature range</b>	-30 °C ... +90 °C, without package

<sup>1)</sup> With male connector and mating connector fitted minimum IP65.

<sup>2)</sup> At operating temperature measuring point.

<sup>3)</sup> Checked during operation using vector length monitoring.

<b>Resistance to shocks</b>	100 g, 6 ms (according to EN 60068-2-27) <sup>3)</sup>
<b>Frequency range of resistance to vibrations</b>	30 g, 10 Hz ... 1,000 Hz (EN 60068-2-6) <sup>3)</sup>

<sup>1)</sup> With male connector and mating connector fitted minimum IP65.

<sup>2)</sup> At operating temperature measuring point.

<sup>3)</sup> Checked during operation using vector length monitoring.

### Classifications

<b>ECl@ss 5.0</b>	27272501
<b>ECl@ss 5.1.4</b>	27272501
<b>ECl@ss 6.0</b>	27272590
<b>ECl@ss 6.2</b>	27272590
<b>ECl@ss 7.0</b>	27272590
<b>ECl@ss 8.0</b>	27272590
<b>ECl@ss 8.1</b>	27272590
<b>ECl@ss 9.0</b>	27272590
<b>ECl@ss 10.0</b>	27272501
<b>ECl@ss 11.0</b>	27272501
<b>ETIM 5.0</b>	EC001486
<b>ETIM 6.0</b>	EC001486
<b>ETIM 7.0</b>	EC001486
<b>UNSPSC 16.0901</b>	41112113

Dimensional drawing (Dimensions in mm (inch))

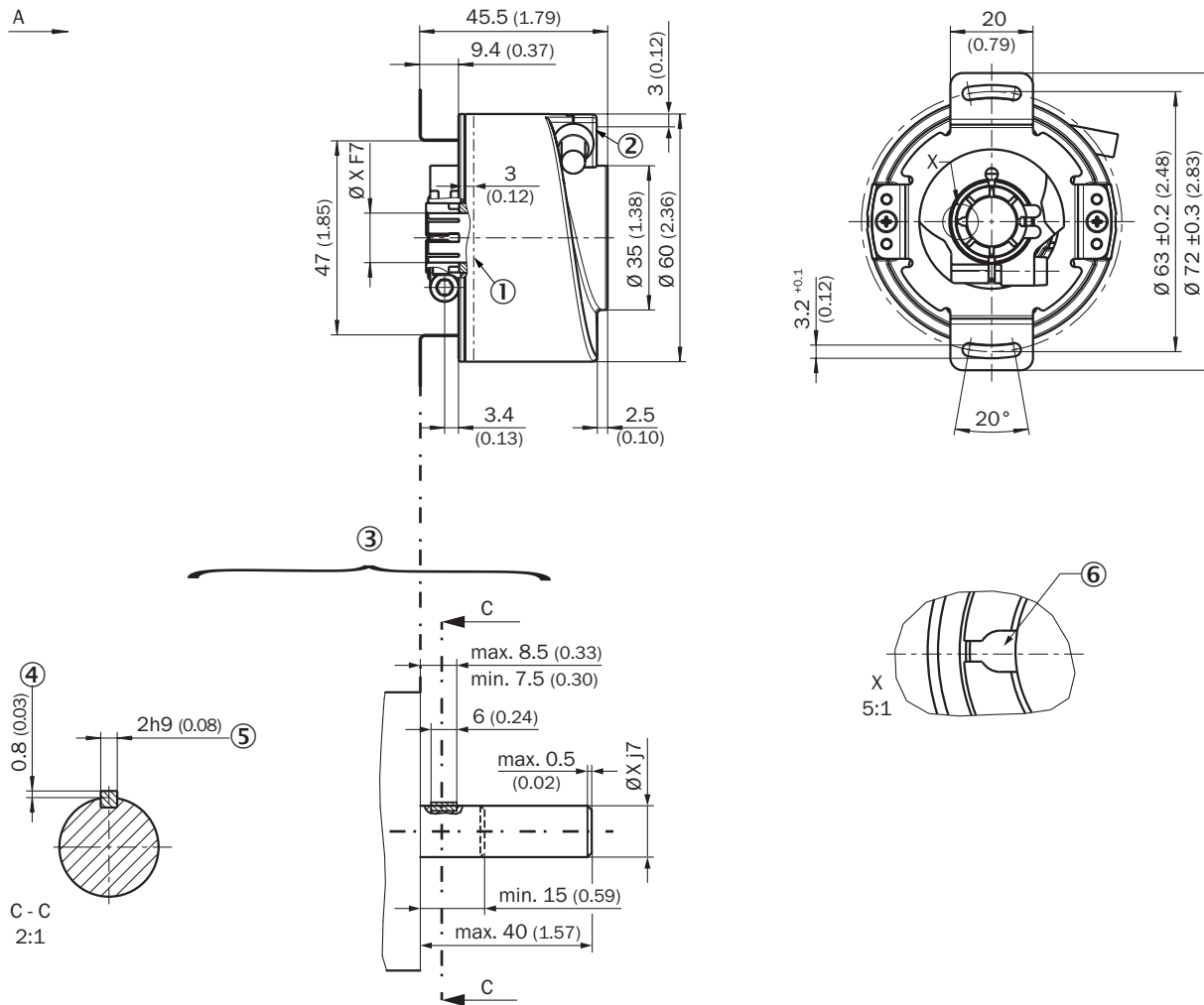

- ① Operating temperature measuring point (freely selectable, around the housing surface area in each case, approx. 3 mm away from flange)
- ② Measuring point vibration (respectively at the housing face. approx. 3 mm away from the cover edge)
- ③ Attachment specifications
- ④ Max. 0.4 at  $\varnothing 5/8"$
- ⑤ Feather key DIN 6885-A 2x2x6
- ⑥ Feather key groove

**Diagrams**

Signal SIN/COS after differential generation

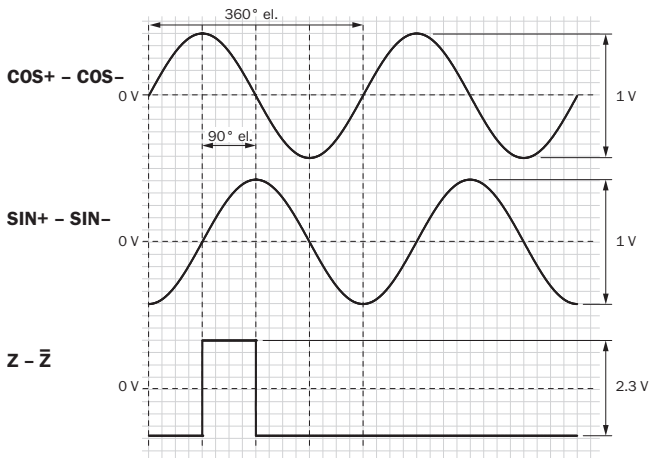

For clockwise shaft rotation, looking in direction “A” (see dimensional drawing)  
Signal SIN/COS before differential generation

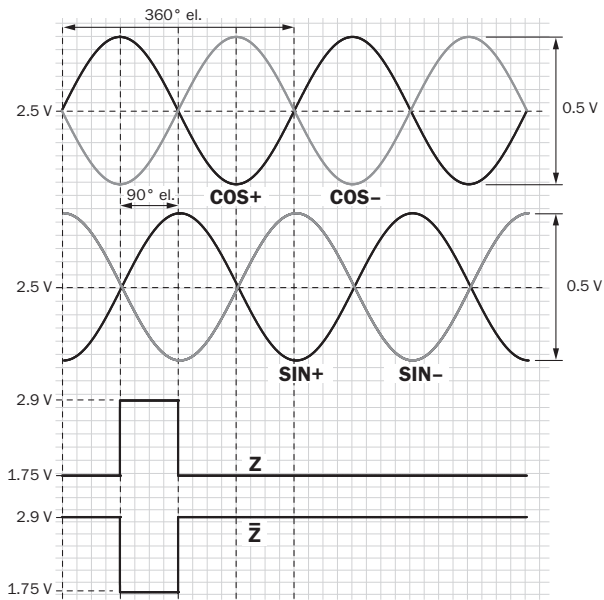







For clockwise shaft rotation, looking in direction “A” (see dimensional drawing)

**Recommended accessories**

Other models and accessories → [www.sick.com/DFS60S\\_Pro](http://www.sick.com/DFS60S_Pro)

	<b>Brief description</b>	<b>Type</b>	<b>Part no.</b>
<b>Plug connectors and cables</b>			
	Head A: cable Head B: Flying leads Cable: SSI, Incremental, HIPERFACE®, PUR, halogen-free, shielded	LTG-2308-MWENC	6027529

	Brief description	Type	Part no.
	Head A: cable Head B: Flying leads Cable: SSI, Incremental, PUR, shielded	LTG-2411-MW	6027530
	Head A: cable Head B: Flying leads Cable: SSI, Incremental, PUR, halogen-free, shielded	LTG-2512-MW	6027531
	Head A: cable Head B: Flying leads Cable: SSI, TTL, HTL, Incremental, PUR, halogen-free, shielded	LTG-2612-MW	6028516
	Head A: female connector, M12, 8-pin, straight, A-coded Head B: - Cable: Incremental, SSI, shielded	DOS-1208-GA01	6045001
	Head A: male connector, M12, 8-pin, straight, A-coded Head B: - Cable: Incremental, shielded	STE-1208-GA01	6044892
	Head A: male connector, M23, 12-pin, straight Head B: - Cable: HIPERFACE <sup>®</sup> , SSI, Incremental, shielded	STE-2312-G01	2077273

## SICK AT A GLANCE

SICK is one of the leading manufacturers of intelligent sensors and sensor solutions for industrial applications. A unique range of products and services creates the perfect basis for controlling processes securely and efficiently, protecting individuals from accidents and preventing damage to the environment.

We have extensive experience in a wide range of industries and understand their processes and requirements. With intelligent sensors, we can deliver exactly what our customers need. In application centers in Europe, Asia and North America, system solutions are tested and optimized in accordance with customer specifications. All this makes us a reliable supplier and development partner.

Comprehensive services complete our offering: SICK LifeTime Services provide support throughout the machine life cycle and ensure safety and productivity.

For us, that is “Sensor Intelligence.”

## WORLDWIDE PRESENCE:

Contacts and other locations –[www.sick.com](http://www.sick.com)