

# DBV50E-22AMA1000

DBV50 Core

MEASURING WHEEL ENCODERS

**SICK**  
Sensor Intelligence.



Illustration may differ



### Ordering information

| Type             | Part no. |
|------------------|----------|
| DBV50E-22AMA1000 | 1081682  |

Other models and accessories → [www.sick.com/DBV50\\_Core](http://www.sick.com/DBV50_Core)

### Detailed technical data

#### Performance

|                                                     |                                                            |
|-----------------------------------------------------|------------------------------------------------------------|
| <b>Pulses per revolution</b>                        | 1,000                                                      |
| <b>Resolution in pulses/mm</b>                      | 5                                                          |
| <b>Measuring increment (resolution in mm/pulse)</b> | 0.2                                                        |
| <b>Measuring step deviation</b>                     | ± 18° / pulses per revolution                              |
| <b>Error limits</b>                                 | ± 4 mm/m, subject to the measuring wheel (wheel + surface) |
| <b>Duty cycle</b>                                   | ≤ 0.5 ± 5 %                                                |
| <b>Initialization time</b>                          | < 3 ms                                                     |

#### Interfaces

|                                       |              |
|---------------------------------------|--------------|
| <b>Communication interface</b>        | Incremental  |
| <b>Communication Interface detail</b> | TTL / RS-422 |
| <b>Number of signal channels</b>      | 6-channel    |

#### Electrical data

|                                                |                                             |
|------------------------------------------------|---------------------------------------------|
| <b>Operating power consumption (no load)</b>   | 50 mA                                       |
| <b>Connection type</b>                         | Cable, 8-wire, universal, 5 m <sup>1)</sup> |
| <b>Supply voltage</b>                          | 4.5 V ... 5.5 V                             |
| <b>Load current max.</b>                       | 30 mA                                       |
| <b>Maximum output frequency</b>                | ≤ 300 kHz                                   |
| <b>Reference signal, number</b>                | 1                                           |
| <b>Reference signal, position</b>              | 90°, electric, logically gated with A and B |
| <b>Reverse polarity protection</b>             | -                                           |
| <b>Short-circuit protection of the outputs</b> | ✓ <sup>2)</sup>                             |
| <b>MTTFd: mean time to dangerous failure</b>   | 600 years (EN ISO 13849-1) <sup>3)</sup>    |

<sup>1)</sup> Number of wires depending on electrical interface: Interface A, C, E: 8-wire; Interface G, P, R: 5-wire.

<sup>2)</sup> The short-circuit rating is only given if Us and GND are connected correctly.

<sup>3)</sup> This product is a standard product and does not constitute a safety component as defined in the Machinery Directive. Calculation based on nominal load of components, average ambient temperature 40°C, frequency of use 8760 h/a. All electronic failures are considered hazardous. For more information, see document no. 8015532.

## Mechanical data

|                                                                            |                                                                   |
|----------------------------------------------------------------------------|-------------------------------------------------------------------|
| <b>Measuring wheel circumference</b>                                       | 200 mm                                                            |
| <b>Measuring wheel surface</b>                                             | O-ring NBR70 <sup>1)</sup>                                        |
| <b>Spring arm design</b>                                                   | 63.5 mm spring arm, encoder on mounting side (left), single wheel |
| <b>Mass</b>                                                                | + 300 g                                                           |
| <b>Shaft</b>                                                               | Stainless steel                                                   |
| <b>Flange</b>                                                              | Aluminum                                                          |
| <b>Housing</b>                                                             | Aluminum                                                          |
| <b>Cable</b>                                                               | PVC                                                               |
| <b>Spring element</b>                                                      | Spring steel, anti-corrosive                                      |
| <b>Measuring wheel, spring arm</b>                                         | Aluminum                                                          |
| <b>Start up torque</b>                                                     | 0.9 Ncm (at 20 °C)                                                |
| <b>Operating torque</b>                                                    | 0.6 Ncm (at 20 °C)                                                |
| <b>Operating speed</b>                                                     | 1,500 min <sup>-1</sup>                                           |
| <b>Maximum operating speed</b>                                             | 3,000 min <sup>-1 2)</sup>                                        |
| <b>Bearing lifetime</b>                                                    | 2.0 x 10 <sup>9</sup> revolutions                                 |
| <b>Maximum travel/deflection of spring arm</b>                             | 14 mm At 14 N spring travel                                       |
| <b>Recommended pretension</b>                                              | 15 N At 10 mm deflection <sup>3)</sup>                            |
| <b>Max. permissible working area for the spring (continuous operation)</b> | ± 3 mm                                                            |
| <b>Recommended spring deflection</b>                                       | 2 mm ... 13 mm                                                    |
| <b>Service life of spring element</b>                                      | > 1.4 million cycles <sup>4)</sup>                                |
| <b>Mounting position relative to the measuring object</b>                  | Preferably from above, from below possible <sup>5)</sup>          |

<sup>1)</sup> The surface of a measuring wheel is subject to wear. This depends on contact pressure, acceleration behavior in the application, traversing speed, measurement surface, mechanical alignment of the measuring wheel, temperature, and ambient conditions. We recommend you regularly check the condition of the measuring wheel and replace as required.

<sup>2)</sup> No permanent operation. Decreasing signal quality.

<sup>3)</sup> When measured from the top of the measuring surface.

<sup>4)</sup> One cycle corresponds to an upward and downward movement of ± 3 mm from the recommended pretension position.

<sup>5)</sup> When mounted from below, the encoder weight during spring pretensioning must be taken into account.

## Ambient data

|                                      |                                                           |
|--------------------------------------|-----------------------------------------------------------|
| <b>EMC</b>                           | According to EN 61000-6-2 and EN 61000-6-3 (class A)      |
| <b>Enclosure rating</b>              | IP65                                                      |
| <b>Permissible relative humidity</b> | 90 % (condensation of the optical scanning not permitted) |
| <b>Operating temperature range</b>   | -20 °C ... +85 °C (on request)<br>-35 °C ... +95 °C       |
| <b>Storage temperature range</b>     | -40 °C ... +100 °C, without package                       |

## Classifications

|                     |          |
|---------------------|----------|
| <b>ECl@ss 5.0</b>   | 27270501 |
| <b>ECl@ss 5.1.4</b> | 27270501 |
| <b>ECl@ss 6.0</b>   | 27270590 |
| <b>ECl@ss 6.2</b>   | 27270590 |
| <b>ECl@ss 7.0</b>   | 27270501 |

|                       |          |
|-----------------------|----------|
| <b>ECl@ss 8.0</b>     | 27270501 |
| <b>ECl@ss 8.1</b>     | 27270501 |
| <b>ECl@ss 9.0</b>     | 27270501 |
| <b>ECl@ss 10.0</b>    | 27270790 |
| <b>ECl@ss 11.0</b>    | 27270707 |
| <b>ETIM 5.0</b>       | EC001486 |
| <b>ETIM 6.0</b>       | EC001486 |
| <b>ETIM 7.0</b>       | EC001486 |
| <b>UNSPSC 16.0901</b> | 41112113 |

### Dimensional drawing (Dimensions in mm (inch))

63.5 mm spring arm, encoder on mounting side (left), single wheel

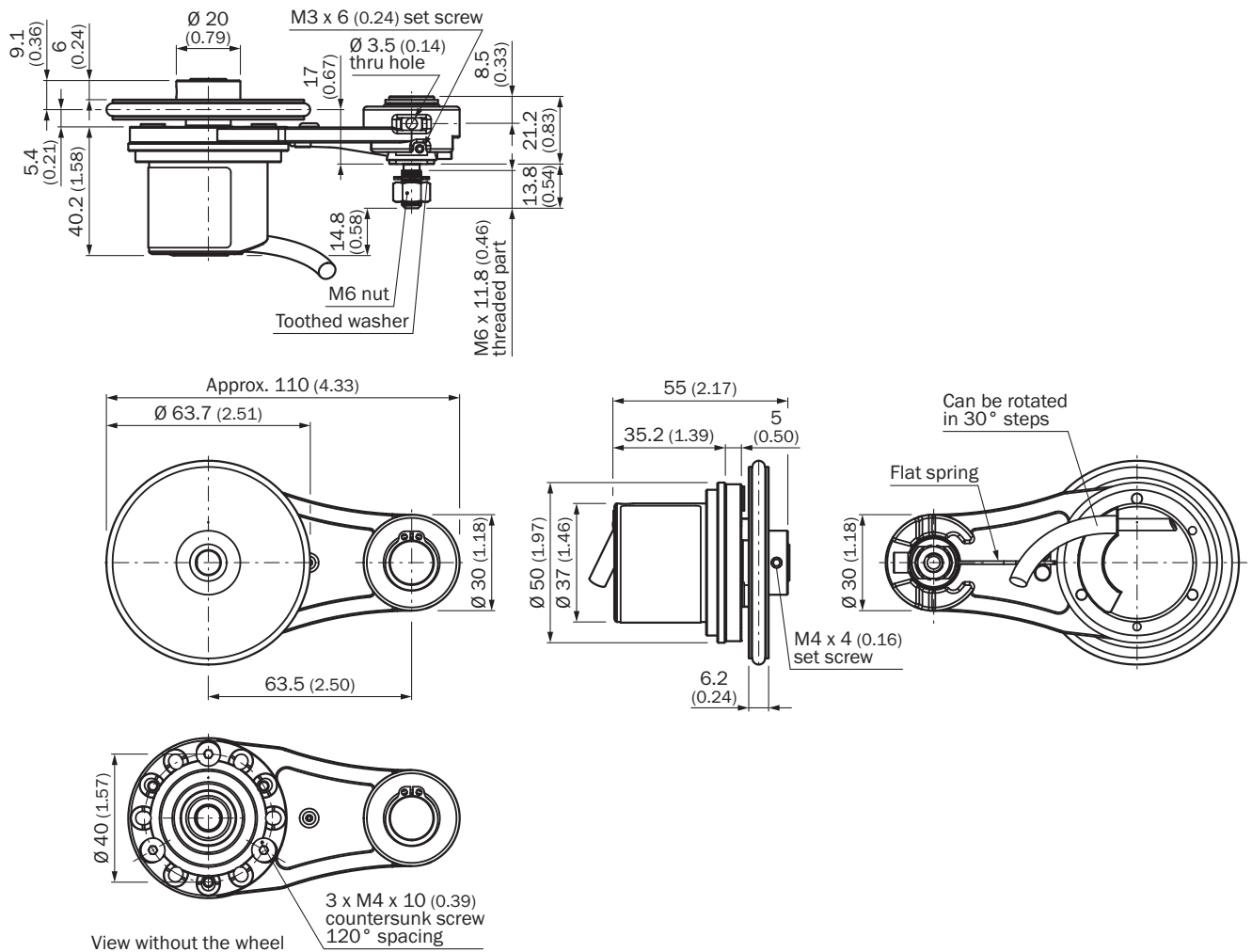

Attachment specifications

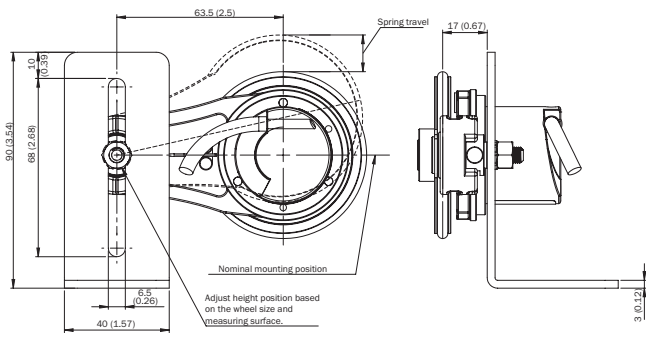

PIN assignment

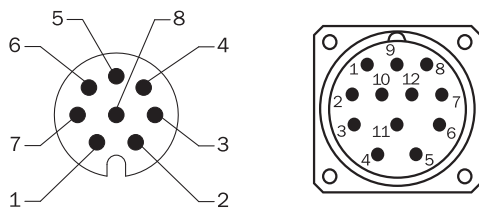

View of M12 / M23 male device connector on cable / housing

| Wire colors (cable connection) | Male connector M12, 8-pin | Male connector M23, 12-pin | HTL/OC 3-channel signal | TTL/HTL 6-channel signal | Explanation                         |
|--------------------------------|---------------------------|----------------------------|-------------------------|--------------------------|-------------------------------------|
| Brown                          | 1                         | 6                          | N.C.                    | A-                       | Signal wire                         |
| White                          | 2                         | 5                          | A                       | A                        | Signal wire                         |
| Black                          | 3                         | 1                          | N.C.                    | B-                       | Signal wire                         |
| Pink                           | 4                         | 8                          | B                       | B                        | Signal wire                         |
| Yellow                         | 5                         | 4                          | N.C.                    | Z-                       | Signal wire                         |
| Purple                         | 6                         | 3                          | Z                       | Z                        | Signal wire                         |
| Blue                           | 7                         | 10                         | GND                     | GND                      | Ground connection                   |
| Red                            | 8                         | 12                         | U <sub>S</sub>          | U <sub>S</sub>           | Supply voltage                      |
| -                              | -                         | 9                          | N.C.                    | N.C.                     | Not assigned                        |
| -                              | -                         | 2                          | N.C.                    | N.C.                     | Not assigned                        |
| -                              | -                         | 11                         | N.C.                    | N.C.                     | Not assigned                        |
| -                              | -                         | 7                          | N.C.                    | N.C.                     | Not assigned                        |
| Screen                         | Screen                    | Screen                     | Screen                  | Screen                   | Screen connected to encoder housing |

### Diagrams

Force deflection chart with working range

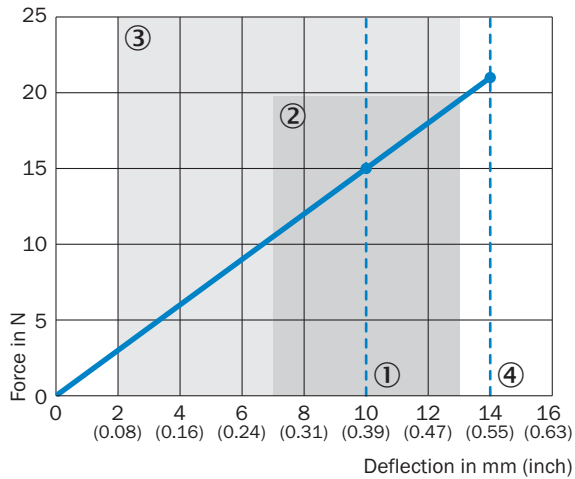

- ① Proposed Pre-tension: 10 mm
- ② Allowed operating travel (continuous operation) +/- 3 mm
- ③ Proposed spring deflection: 2 - 13 mm
- ④ Maximum spring travel: 14 mm

Signal outputs for electrical interfaces TTL and HTL

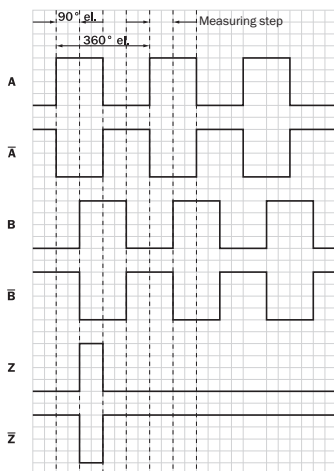









CW with view on the encoder shaft, compare dimensional drawing. Interfaces G, P, R perform only the channels A, B, Z.

### Recommended accessories

Other models and accessories → [www.sick.com/DBV50\\_Core](http://www.sick.com/DBV50_Core)

|                                                                                     | Brief description                                 | Type       | Part no. |
|-------------------------------------------------------------------------------------|---------------------------------------------------|------------|----------|
| Flanges                                                                             |                                                   |            |          |
|  | Adapter flange for modular measuring wheel system | BEF-AP-MRS | 2084969  |

|                                                                                     | Brief description                                                                                                                    | Type             | Part no. |
|-------------------------------------------------------------------------------------|--------------------------------------------------------------------------------------------------------------------------------------|------------------|----------|
| <b>Mounting brackets and plates</b>                                                 |                                                                                                                                      |                  |          |
|    | Mounting bracket for encoder with spigot 36 mm                                                                                       | BEF-WF-MRS       | 2084709  |
| <b>Other mounting accessories</b>                                                   |                                                                                                                                      |                  |          |
|    | Aluminium measuring wheel with O-ring (NBR70) for 8 mm solid shaft, circumference 200 mm                                             | BEF-MR008020R    | 2055223  |
|                                                                                     | O-ring for measuring wheels (circumference 200 mm)                                                                                   | BEF-OR-053-040   | 2064061  |
| <b>Plug connectors and cables</b>                                                   |                                                                                                                                      |                  |          |
|    | Head A: cable<br>Head B: Flying leads<br>Cable: SSI, Incremental, HIPERFACE®, PUR, halogen-free, shielded                            | LTG-2308-MWENC   | 6027529  |
|    | Head A: cable<br>Head B: Flying leads<br>Cable: SSI, Incremental, PUR, shielded                                                      | LTG-2411-MW      | 6027530  |
|    | Head A: cable<br>Head B: Flying leads<br>Cable: SSI, Incremental, PUR, halogen-free, shielded                                        | LTG-2512-MW      | 6027531  |
|    | Head A: cable<br>Head B: Flying leads<br>Cable: SSI, TTL, HTL, Incremental, PUR, halogen-free, shielded                              | LTG-2612-MW      | 6028516  |
|   | Head A: female connector, M12, 8-pin, straight<br>Head B: Flying leads<br>Cable: Incremental, SSI, PUR, halogen-free, shielded, 2 m  | DOL-1208-G02MAC1 | 6032866  |
|                                                                                     | Head A: female connector, M12, 8-pin, straight<br>Head B: Flying leads<br>Cable: Incremental, SSI, PUR, halogen-free, shielded, 5 m  | DOL-1208-G05MAC1 | 6032867  |
|                                                                                     | Head A: female connector, M12, 8-pin, straight<br>Head B: Flying leads<br>Cable: Incremental, SSI, PUR, halogen-free, shielded, 10 m | DOL-1208-G10MAC1 | 6032868  |
|                                                                                     | Head A: female connector, M12, 8-pin, straight<br>Head B: Flying leads<br>Cable: Incremental, SSI, PUR, halogen-free, shielded, 20 m | DOL-1208-G20MAC1 | 6032869  |
|                                                                                     | Head A: female connector, M12, 8-pin, straight<br>Head B: Flying leads<br>Cable: Incremental, SSI, PUR, halogen-free, shielded, 25 m | DOL-1208-G25MAC1 | 6067859  |
|                                                                                     | Head A: female connector, M12, 8-pin, straight, A-coded<br>Head B: -<br>Cable: Incremental, SSI, shielded                            | DOS-1208-GA01    | 6045001  |
|  | Head A: female connector, M23, 9-pin, straight<br>Cable: HIPERFACE®, SSI, Incremental, shielded                                      | DOS-2309-G       | 6028533  |
|  | Head A: female connector, M23, 12-pin, straight<br>Head B: -<br>Cable: HIPERFACE®, SSI, Incremental, shielded                        | DOS-2312-G       | 6027538  |
|                                                                                     |                                                                                                                                      | DOS-2312-G02     | 2077057  |
|  | Head A: female connector, M23, 12-pin, angled<br>Head B: -<br>Cable: HIPERFACE®, SSI, Incremental, shielded                          | DOS-2312-W01     | 2072580  |
|  | Head A: male connector, M12, 8-pin, straight, A-coded<br>Head B: -<br>Cable: Incremental, shielded                                   | STE-1208-GA01    | 6044892  |

|                                                                                   | Brief description                                                                                                                | Type         | Part no. |
|-----------------------------------------------------------------------------------|----------------------------------------------------------------------------------------------------------------------------------|--------------|----------|
|  | Head A: male connector, M23, 12-pin, straight<br>Head B: -<br>Cable: HIPERFACE <sup>®</sup> , SSI, Incremental, RS-422, shielded | STE-2312-G   | 6027537  |
|  | Head A: male connector, M23, 12-pin, straight<br>Head B: -<br>Cable: HIPERFACE <sup>®</sup> , SSI, Incremental, shielded         | STE-2312-G01 | 2077273  |



## SICK AT A GLANCE

SICK is one of the leading manufacturers of intelligent sensors and sensor solutions for industrial applications. A unique range of products and services creates the perfect basis for controlling processes securely and efficiently, protecting individuals from accidents and preventing damage to the environment.

We have extensive experience in a wide range of industries and understand their processes and requirements. With intelligent sensors, we can deliver exactly what our customers need. In application centers in Europe, Asia and North America, system solutions are tested and optimized in accordance with customer specifications. All this makes us a reliable supplier and development partner.

Comprehensive services complete our offering: SICK LifeTime Services provide support throughout the machine life cycle and ensure safety and productivity.

For us, that is “Sensor Intelligence.”

## WORLDWIDE PRESENCE:

Contacts and other locations –[www.sick.com](http://www.sick.com)