

DBV50E-22AKB0200

DBV50 Core

MEASURING WHEEL ENCODERS

SICK
Sensor Intelligence.

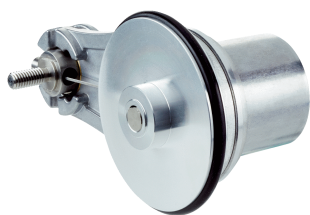

Ordering information

Type	Part no.
DBV50E-22AKB0200	1081466

Other models and accessories → www.sick.com/DBV50_Core

Illustration may differ



Detailed technical data

Performance

Pulses per revolution	200
Resolution in pulses/mm	1
Measuring increment (resolution in mm/pulse)	1
Measuring step deviation	± 18° / pulses per revolution
Error limits	± 4 mm/m, subject to the measuring wheel (wheel + surface)
Duty cycle	≤ 0.5 ± 5 %
Initialization time	< 3 ms

Interfaces

Communication interface	Incremental
Communication Interface detail	TTL / RS-422
Number of signal channels	6-channel

Electrical data

Operating power consumption (no load)	50 mA
Connection type	Cable, 8-wire, universal, 1.5 m ¹⁾
Supply voltage	4.5 V ... 5.5 V
Load current max.	30 mA
Maximum output frequency	≤ 300 kHz
Reference signal, number	1
Reference signal, position	90°, electric, logically gated with A and B
Reverse polarity protection	-
Short-circuit protection of the outputs	✓ ²⁾
MTTFd: mean time to dangerous failure	600 years (EN ISO 13849-1) ³⁾

¹⁾ Number of wires depending on electrical interface: Interface A, C, E: 8-wire; Interface G, P, R: 5-wire.

²⁾ The short-circuit rating is only given if Us and GND are connected correctly.

³⁾ This product is a standard product and does not constitute a safety component as defined in the Machinery Directive. Calculation based on nominal load of components, average ambient temperature 40°C, frequency of use 8760 h/a. All electronic failures are considered hazardous. For more information, see document no. 8015532.

Mechanical data

Measuring wheel circumference	200 mm
Measuring wheel surface	O-ring NBR70 ¹⁾
Spring arm design	63.5 mm spring arm, wheel on mounting side (right), single wheel
Mass	+ 300 g
Shaft	Stainless steel
Flange	Aluminum
Housing	Aluminum
Cable	PVC
Spring element	Spring steel, anti-corrosive
Measuring wheel, spring arm	Aluminum
Start up torque	0.9 Ncm (at 20 °C)
Operating torque	0.6 Ncm (at 20 °C)
Operating speed	1,500 min ⁻¹
Maximum operating speed	3,000 min ⁻¹ ²⁾
Bearing lifetime	2.0 x 10 ⁹ revolutions
Maximum travel/deflection of spring arm	14 mm At 14 N spring travel
Recommended pretension	15 N At 10 mm deflection ³⁾
Max. permissible working area for the spring (continuous operation)	± 3 mm
Recommended spring deflection	2 mm ... 13 mm
Service life of spring element	> 1.4 million cycles ⁴⁾
Mounting position relative to the measuring object	Preferably from above, from below possible ⁵⁾

¹⁾ The surface of a measuring wheel is subject to wear. This depends on contact pressure, acceleration behavior in the application, traversing speed, measurement surface, mechanical alignment of the measuring wheel, temperature, and ambient conditions. We recommend you regularly check the condition of the measuring wheel and replace as required.

²⁾ No permanent operation. Decreasing signal quality.

³⁾ When measured from the top of the measuring surface.

⁴⁾ One cycle corresponds to an upward and downward movement of ± 3 mm from the recommended pretension position.

⁵⁾ When mounted from below, the encoder weight during spring pretensioning must be taken into account.

Ambient data

EMC	According to EN 61000-6-2 and EN 61000-6-3 (class A)
Enclosure rating	IP65
Permissible relative humidity	90 % (condensation of the optical scanning not permitted)
Operating temperature range	-20 °C ... +85 °C (on request) -35 °C ... +95 °C
Storage temperature range	-40 °C ... +100 °C, without package

Classifications

ECl@ss 5.0	27270501
ECl@ss 5.1.4	27270501
ECl@ss 6.0	27270590
ECl@ss 6.2	27270590
ECl@ss 7.0	27270501

ECl@ss 8.0	27270501
ECl@ss 8.1	27270501
ECl@ss 9.0	27270501
ECl@ss 10.0	27270790
ECl@ss 11.0	27270707
ETIM 5.0	EC001486
ETIM 6.0	EC001486
ETIM 7.0	EC001486
UNSPSC 16.0901	41112113

Dimensional drawing (Dimensions in mm (inch))

63.5 mm spring arm, wheel on mounting side (right), single wheel

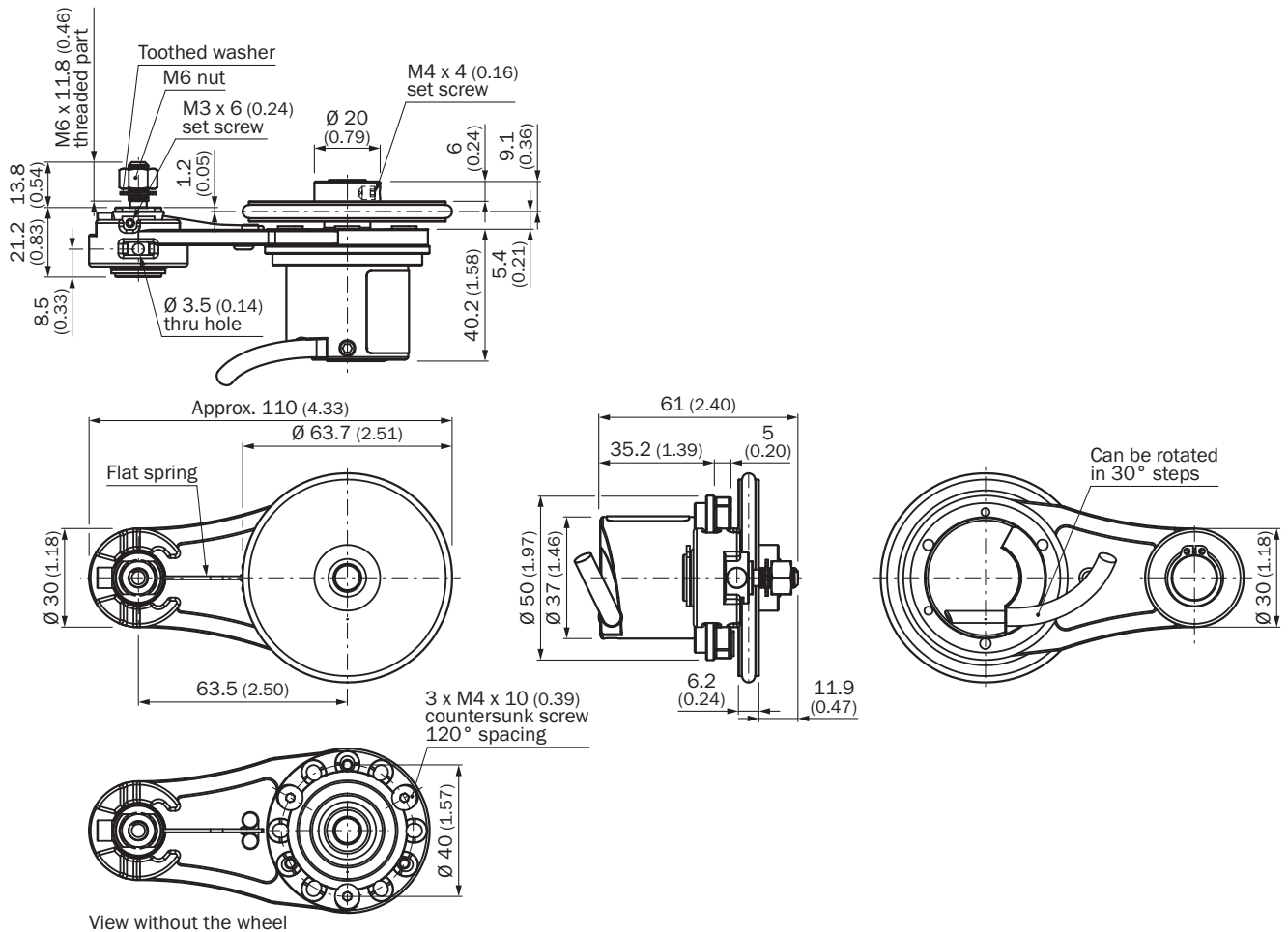

Attachment specifications

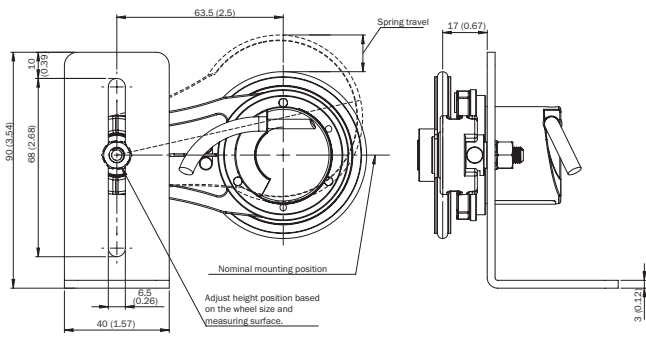

PIN assignment

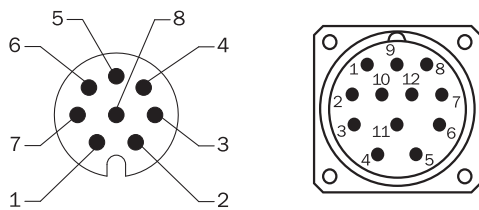

View of M12 / M23 male device connector on cable / housing

Wire colors (cable connection)	Male connector M12, 8-pin	Male connector M23, 12-pin	HTL/OC 3-channel signal	TTL/HTL 6-channel signal	Explanation
Brown	1	6	N.C.	A-	Signal wire
White	2	5	A	A	Signal wire
Black	3	1	N.C.	B-	Signal wire
Pink	4	8	B	B	Signal wire
Yellow	5	4	N.C.	Z-	Signal wire
Purple	6	3	Z	Z	Signal wire
Blue	7	10	GND	GND	Ground connection
Red	8	12	U _S	U _S	Supply voltage
-	-	9	N.C.	N.C.	Not assigned
-	-	2	N.C.	N.C.	Not assigned
-	-	11	N.C.	N.C.	Not assigned
-	-	7	N.C.	N.C.	Not assigned
Screen	Screen	Screen	Screen	Screen	Screen connected to encoder housing

Diagrams

Force deflection chart with working range

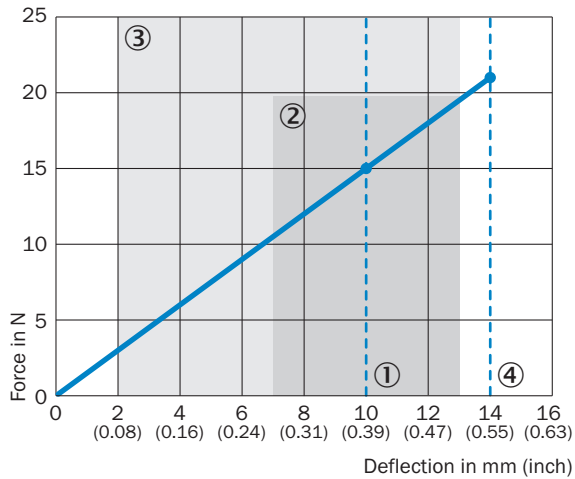

- ① Proposed Pre-tension: 10 mm
- ② Allowed operating travel (continuous operation) +/- 3 mm
- ③ Proposed spring deflection: 2 - 13 mm
- ④ Maximum spring travel: 14 mm

Signal outputs for electrical interfaces TTL and HTL

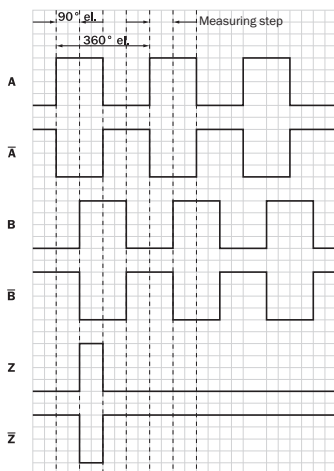







CW with view on the encoder shaft, compare dimensional drawing. Interfaces G, P, R perform only the channels A, B, Z.

Recommended accessories

Other models and accessories → www.sick.com/DBV50_Core

	Brief description	Type	Part no.
Flanges			
	Adapter flange for modular measuring wheel system	BEF-AP-MRS	2084969

	Brief description	Type	Part no.
Mounting brackets and plates			
	Mounting bracket for encoder with spigot 36 mm	BEF-WF-MRS	2084709
Other mounting accessories			
	Aluminium measuring wheel with O-ring (NBR70) for 8 mm solid shaft, circumference 200 mm	BEF-MR008020R	2055223
	O-ring for measuring wheels (circumference 200 mm)	BEF-OR-053-040	2064061
Plug connectors and cables			
	Head A: cable Head B: Flying leads Cable: SSI, Incremental, HIPERFACE®, PUR, halogen-free, shielded	LTG-2308-MWENC	6027529
	Head A: cable Head B: Flying leads Cable: SSI, Incremental, PUR, shielded	LTG-2411-MW	6027530
	Head A: cable Head B: Flying leads Cable: SSI, Incremental, PUR, halogen-free, shielded	LTG-2512-MW	6027531
	Head A: cable Head B: Flying leads Cable: SSI, TTL, HTL, Incremental, PUR, halogen-free, shielded	LTG-2612-MW	6028516
	Head A: female connector, M12, 8-pin, straight Head B: Flying leads Cable: Incremental, SSI, PUR, halogen-free, shielded, 2 m	DOL-1208-G02MAC1	6032866
	Head A: female connector, M12, 8-pin, straight Head B: Flying leads Cable: Incremental, SSI, PUR, halogen-free, shielded, 5 m	DOL-1208-G05MAC1	6032867
	Head A: female connector, M12, 8-pin, straight Head B: Flying leads Cable: Incremental, SSI, PUR, halogen-free, shielded, 10 m	DOL-1208-G10MAC1	6032868
	Head A: female connector, M12, 8-pin, straight Head B: Flying leads Cable: Incremental, SSI, PUR, halogen-free, shielded, 20 m	DOL-1208-G20MAC1	6032869
	Head A: female connector, M12, 8-pin, straight Head B: Flying leads Cable: Incremental, SSI, PUR, halogen-free, shielded, 25 m	DOL-1208-G25MAC1	6067859
	Head A: female connector, M12, 8-pin, straight, A-coded Head B: - Cable: Incremental, SSI, shielded	DOS-1208-GA01	6045001
	Head A: female connector, M23, 9-pin, straight Cable: HIPERFACE®, SSI, Incremental, shielded	DOS-2309-G	6028533
	Head A: female connector, M23, 12-pin, straight Head B: -	DOS-2312-G	6027538
	Cable: HIPERFACE®, SSI, Incremental, shielded	DOS-2312-G02	2077057
	Head A: female connector, M23, 12-pin, angled Head B: - Cable: HIPERFACE®, SSI, Incremental, shielded	DOS-2312-W01	2072580
	Head A: male connector, M12, 8-pin, straight, A-coded Head B: - Cable: Incremental, shielded	STE-1208-GA01	6044892

	Brief description	Type	Part no.
	Head A: male connector, M23, 12-pin, straight Head B: - Cable: HIPERFACE [®] , SSI, Incremental, RS-422, shielded	STE-2312-G	6027537
	Head A: male connector, M23, 12-pin, straight Head B: - Cable: HIPERFACE [®] , SSI, Incremental, shielded	STE-2312-G01	2077273

SICK AT A GLANCE

SICK is one of the leading manufacturers of intelligent sensors and sensor solutions for industrial applications. A unique range of products and services creates the perfect basis for controlling processes securely and efficiently, protecting individuals from accidents and preventing damage to the environment.

We have extensive experience in a wide range of industries and understand their processes and requirements. With intelligent sensors, we can deliver exactly what our customers need. In application centers in Europe, Asia and North America, system solutions are tested and optimized in accordance with customer specifications. All this makes us a reliable supplier and development partner.

Comprehensive services complete our offering: SICK LifeTime Services provide support throughout the machine life cycle and ensure safety and productivity.

For us, that is “Sensor Intelligence.”

WORLDWIDE PRESENCE:

Contacts and other locations –www.sick.com