



# WLA16P-1H162100A00

W16

SMALL PHOTOELECTRIC SENSORS

**SICK**  
Sensor Intelligence.



Illustration may differ



### Ordering information

| Type               | Part no. |
|--------------------|----------|
| WLA16P-1H162100A00 | 1218826  |

Other models and accessories → [www.sick.com/W16](http://www.sick.com/W16)

### Detailed technical data

#### Features

|  |  |                    |                          |                     |   |                      |   |
|--|--|--------------------|--------------------------|---------------------|---|----------------------|---|
| <b>Sensor/ detection principle</b>     | Photoelectric retro-reflective sensor, autocollimation   |                    |                          |                     |   |                      |   |
| <b>Dimensions (W x H x D)</b>          | 20 mm x 55.7 mm x 42 mm  |                    |                          |                     |   |                      |   |
| <b>Housing design (light emission)</b> | Rectangular  |                    |                          |                     |   |                      |   |
| <b>Sensing range max.</b>              | 0 m ... 10 m <sup>1)</sup>   |                    |                          |                     |   |                      |   |
| <b>Type of light</b>                   | Visible red light  |                    |                          |                     |   |                      |   |
| <b>Light source</b>                    | PinPoint LED <sup>2)</sup>   |                    |                          |                     |   |                      |   |
| <b>Light spot size (distance)</b>      | Ø 80 mm (5 m)  |                    |                          |                     |   |                      |   |
| <b>Wave length</b>                     | 635 nm   |                    |                          |                     |   |                      |   |
| <b>Adjustment</b>                      | IO-Link For configuring the sensor parameters and Smart Task functions   |                    |                          |                     |   |                      |   |
| <b>Indication</b>                      | <table border="0"> <tr> <td>LED indicator blue</td> <td>BluePilot: Alignment aid</td> </tr> <tr> <td>LED indicator green</td> <td>Operating indicator<br/>Static: power on<br/>Flashing: IO-Link mode</td> </tr> <tr> <td>LED indicator yellow</td> <td>Status of received light beam<br/>Static: object not present</td> </tr> </table> | LED indicator blue | BluePilot: Alignment aid | LED indicator green | Operating indicator<br>Static: power on<br>Flashing: IO-Link mode | LED indicator yellow | Status of received light beam<br>Static: object not present |
| LED indicator blue                     | BluePilot: Alignment aid   |                    |                          |                     |   |                      |   |
| LED indicator green                    | Operating indicator<br>Static: power on<br>Flashing: IO-Link mode  |                    |                          |                     |   |                      |   |
| LED indicator yellow                   | Status of received light beam<br>Static: object not present  |                    |                          |                     |   |                      |   |

<sup>1)</sup> Reflector PL80A.

<sup>2)</sup> Average service life: 100,000 h at T<sub>U</sub> = +25 °C.

|                             |  |
|-----------------------------|--|
|                             | Static off: object present<br>Flashing: Below the 1.5 function reserve |
| <b>Pin 2 configuration</b>  | External input, Teach-in, switching signal                             |
| <b>Special applications</b> | Detecting objects wrapped in film                                      |

<sup>1)</sup> Reflector PL80A.

<sup>2)</sup> Average service life: 100,000 h at  $T_U = +25 \text{ °C}$ .

## Mechanics/electronics

|  |   |
|--|---|
| <b>Supply voltage</b>                  | 10 V DC ... 30 V DC <sup>1)</sup>   |
| <b>Ripple</b>                          | $< 5 V_{pp}$  |
| <b>Current consumption</b>             | 30 mA <sup>2)</sup><br>50 mA <sup>3)</sup>  |
| <b>Switching output</b>                | Push-pull: PNP/NPN  |
| <b>Output: Q<sub>L1</sub> / C</b>      | Switching output or IO-Link mode  |
| <b>Output function</b>                 | Factory setting: Pin 2 / white (MF): NPN normally closed (light switching), PNP normally open (dark switching), Pin 4 / black (QL1 / C): NPN normally open (dark switching), PNP normally closed (light switching), IO-Link |
| <b>Switching mode</b>                  | Light/dark switching  |
| <b>Signal voltage PNP HIGH/LOW</b>     | Approx. $V_S - 2.5 \text{ V} / 0 \text{ V}$   |
| <b>Signal voltage NPN HIGH/LOW</b>     | Approx. $V_S / < 2.5 \text{ V}$   |
| <b>Output current I<sub>max.</sub></b> | $\leq 100 \text{ mA}$   |
| <b>Response time</b>                   | $\leq 500 \mu\text{s}$ <sup>4)</sup>  |
| <b>Switching frequency</b>             | 1,000 Hz <sup>5)</sup>  |
| <b>Connection type</b>                 | Cable, 2 m <sup>6)</sup>  |
| <b>Cable material</b>                  | PVC   |
| <b>Circuit protection</b>              | A <sup>7)</sup><br>B <sup>8)</sup><br>C <sup>9)</sup><br>D <sup>10)</sup>   |
| <b>Protection class</b>                | III   |
| <b>Weight</b>                          | 100 g   |
| <b>Polarisation filter</b>             | ✓   |
| <b>Housing material</b>                | Plastic, VISTAL®  |
| <b>Optics material</b>                 | Plastic, PMMA   |
| <b>Enclosure rating</b>                | IP66 (According to EN 60529)<br>IP67 (According to EN 60529)  |

<sup>1)</sup> Limit values.

<sup>2)</sup> 16 V DC ... 30 V DC, without load.

<sup>3)</sup> 10 V DC ... 16 V DC, without load.

<sup>4)</sup> Signal transit time with resistive load in switching mode. Different values possible in COM2 mode.

<sup>5)</sup> With light/dark ratio 1:1 in switching mode. Different values possible in IO-Link mode.

<sup>6)</sup> Do not bend below 0 °C.

<sup>7)</sup> A =  $V_S$  connections reverse-polarity protected.

<sup>8)</sup> B = inputs and output reverse-polarity protected.

<sup>9)</sup> C = interference suppression.

<sup>10)</sup> D = outputs overcurrent and short-circuit protected.

<sup>11)</sup> Replaces IP69K with ISO 20653: 2013-03.

|                                      |   |
|--------------------------------------|---|
|                                      | IP69 (According to EN 60529) <sup>11)</sup> |
| <b>Ambient operating temperature</b> | -40 °C ... +60 °C                           |
| <b>Ambient storage temperature</b>   | -40 °C ... +75 °C                           |
| <b>UL File No.</b>                   | NRKH.E181493 & NRKH7.E181493                |

<sup>1)</sup> Limit values.

<sup>2)</sup> 16 V DC ... 30 V DC, without load.

<sup>3)</sup> 10 V DC ... 16 V DC, without load.

<sup>4)</sup> Signal transit time with resistive load in switching mode. Different values possible in COM2 mode.

<sup>5)</sup> With light/dark ratio 1:1 in switching mode. Different values possible in IO-Link mode.

<sup>6)</sup> Do not bend below 0 °C.

<sup>7)</sup> A = V<sub>S</sub> connections reverse-polarity protected.

<sup>8)</sup> B = inputs and output reverse-polarity protected.

<sup>9)</sup> C = interference suppression.

<sup>10)</sup> D = outputs overcurrent and short-circuit protected.

<sup>11)</sup> Replaces IP69K with ISO 20653: 2013-03.

### Safety-related parameters

|                         |           |
|-------------------------|-----------|
| <b>MTTF<sub>D</sub></b> | 627 years |
| <b>DC<sub>avg</sub></b> | 0%        |

### Communication interface

|                                       |  |
|---------------------------------------|--|
| <b>Communication interface</b>        | IO-Link V1.1   |
| <b>Communication Interface detail</b> | COM2 (38,4 kBaud)  |
| <b>Cycle time</b>                     | 2.3 ms   |
| <b>Process data length</b>            | 16 Bit   |
| <b>Process data structure</b>         | Bit 0 = switching signal Q <sub>L1</sub><br>Bit 1 = switching signal Q <sub>L2</sub><br>Bit 2 ... 15 = empty |
| <b>VendorID</b>                       | 26   |
| <b>DeviceID HEX</b>                   | 0x80016C   |
| <b>DeviceID DEC</b>                   | 8388972  |

### Smart Task

|                            |   |
|----------------------------|---|
| <b>Smart Task name</b>     | Base logics   |
| <b>Logic function</b>      | Direct<br>AND<br>OR<br>Window<br>Hysteresis   |
| <b>Timer function</b>      | Deactivated<br>On delay<br>Off delay<br>ON and OFF delay<br>Impulse (one shot)                    |
| <b>Inverter</b>            | Yes   |
| <b>Switching frequency</b> | SIO Direct: 1000 Hz <sup>1)</sup><br>SIO Logic: 800 Hz <sup>2)</sup><br>IOL: 650 Hz <sup>3)</sup> |

<sup>1)</sup> SIO Direct: sensor operation in standard I/O mode without IO-Link communication and without using internal sensor logic or time parameters (set to "direct"/"deactivated").

<sup>2)</sup> SIO Logic: Sensor operation in standard I/O mode without IO-Link communication. Sensor-internal logic or timing parameters plus Automation Functions used.

<sup>3)</sup> IOL: Sensor operation with full IO-Link communication and usage of logic, timing and Automation Function parameters.

|  |   |
|--|---|
| <b>Response time</b>                   | SIO Direct: 500 $\mu\text{s}$ <sup>1)</sup><br>SIO Logic: 600 $\mu\text{s}$ <sup>2)</sup><br>IOL: 750 $\mu\text{s}$ <sup>3)</sup> |
| <b>Repeatability</b>                   | SIO Direct: 150 $\mu\text{s}$ <sup>1)</sup><br>SIO Logic: 300 $\mu\text{s}$ <sup>2)</sup><br>IOL: 750 $\mu\text{s}$ <sup>3)</sup> |
| <b>Switching signal Q<sub>L1</sub></b> | Switching output  |
| <b>Switching signal Q<sub>L2</sub></b> | Switching output  |

<sup>1)</sup> SIO Direct: sensor operation in standard I/O mode without IO-Link communication and without using internal sensor logic or time parameters (set to "direct"/"deactivated").

<sup>2)</sup> SIO Logic: Sensor operation in standard I/O mode without IO-Link communication. Sensor-internal logic or timing parameters plus Automation Functions used.

<sup>3)</sup> IOL: Sensor operation with full IO-Link communication and usage of logic, timing and Automation Function parameters.

### Classifications

|                       |          |
|-----------------------|----------|
| <b>ECl@ss 5.0</b>     | 27270904 |
| <b>ECl@ss 5.1.4</b>   | 27270904 |
| <b>ECl@ss 6.0</b>     | 27270904 |
| <b>ECl@ss 6.2</b>     | 27270904 |
| <b>ECl@ss 7.0</b>     | 27270904 |
| <b>ECl@ss 8.0</b>     | 27270904 |
| <b>ECl@ss 8.1</b>     | 27270904 |
| <b>ECl@ss 9.0</b>     | 27270904 |
| <b>ECl@ss 10.0</b>    | 27270904 |
| <b>ECl@ss 11.0</b>    | 27270904 |
| <b>ETIM 5.0</b>       | EC002719 |
| <b>ETIM 6.0</b>       | EC002719 |
| <b>ETIM 7.0</b>       | EC002719 |
| <b>UNSPSC 16.0901</b> | 39121528 |

### Connection diagram

Cd-389

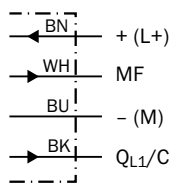

### Characteristic curve

Reflective tape

Function reserve

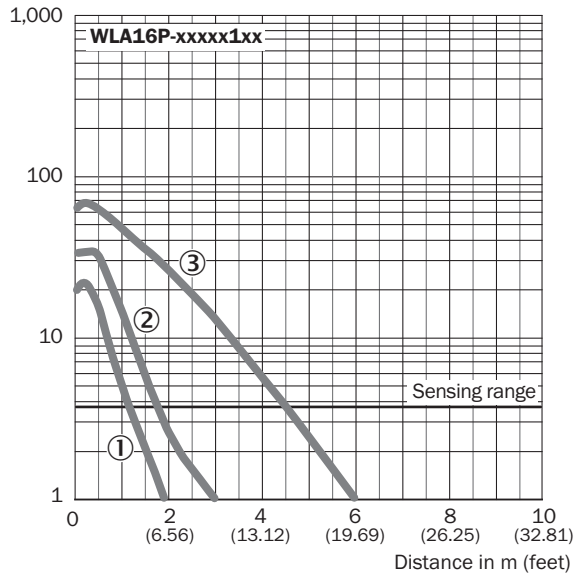

- ① Reflective tape REF-DG (50 x 50 mm)
- ② Reflective tape REF-IRF-56 (50 x 50 mm)
- ③ Reflective tape REF-AC1000 (50 x 50 mm)

Standard reflectors

Function reserve

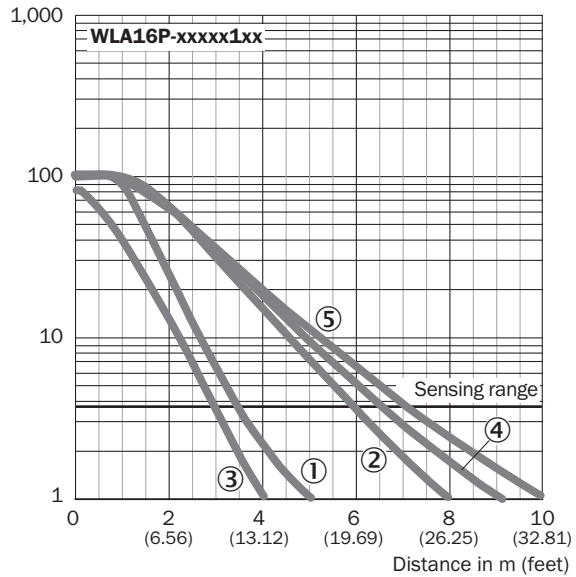

- ① Reflector PL22
- ② Reflector P250, PL30A
- ③ Reflector PL20A
- ④ Reflector PL40A
- ⑤ Reflector PL80A, C110A

Fine triple reflectors

Function reserve

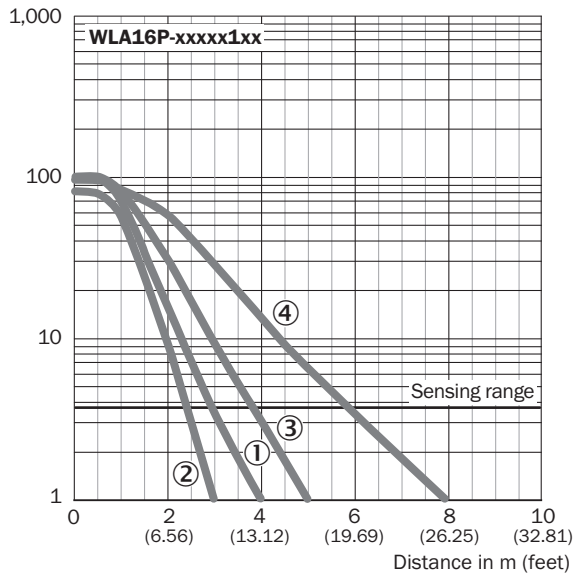

- ① PL10FH-1 reflector
- ② PL10F reflector
- ③ Reflector PL20F
- ④ Reflector P250F

Chemical-resistant reflectors

Function reserve

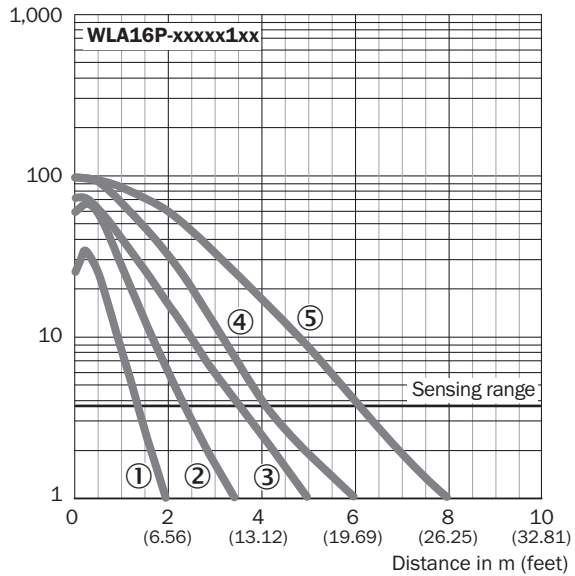

- ① PL10F CHEM reflector
- ② Reflector PL20 CHEM
- ③ Reflector P250 CHEM
- ④ Reflector P250H
- ⑤ Reflector PL40A Antifog

### Light spot size

WLA16P-xxxxx1xx

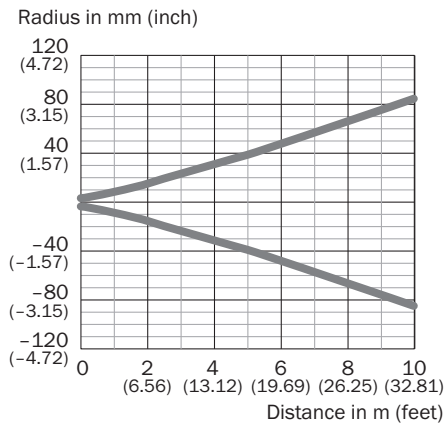

### Sensing range diagram

Reflective tape

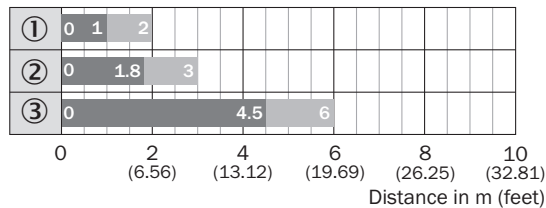

■ Sensing range      ■ Sensing range typ. max.

WLA16P-xxxxx1xx

- ① Reflective tape REF-DG (50 x 50 mm)
- ② Reflective tape REF-IRF-56 (50 x 50 mm)
- ③ Reflective tape REF-AC1000 (50 x 50 mm)

Standard reflectors

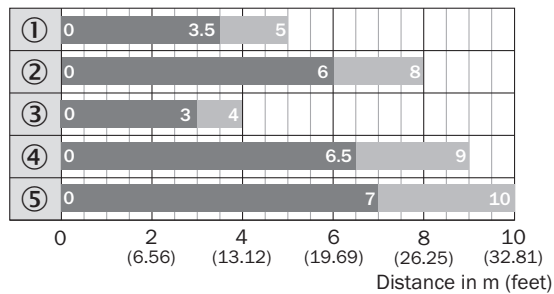

■ Sensing range      ■ Sensing range typ. max.

WLA16P-xxxxx1xx

- ① Reflector PL22
- ② Reflector P250, PL30A
- ③ Reflector PL20A
- ④ Reflector PL40A
- ⑤ Reflector PL80A, C110A



**Chemical-resistant reflectors**

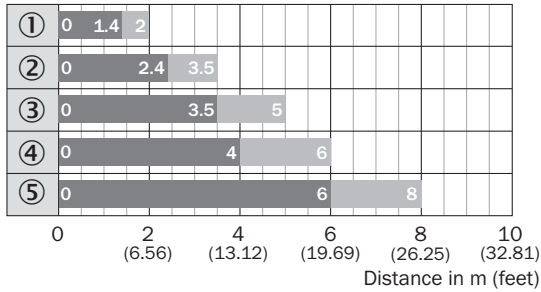

■ Sensing range      ■ Sensing range typ. max.

WLA16P-xxxx1xx

- ① PL10F CHEM reflector
- ② Reflector PL20 CHEM
- ③ Reflector P250 CHEM
- ④ Reflector P250H
- ⑤ Reflector PL40A Antifog

**Fine triple reflectors**

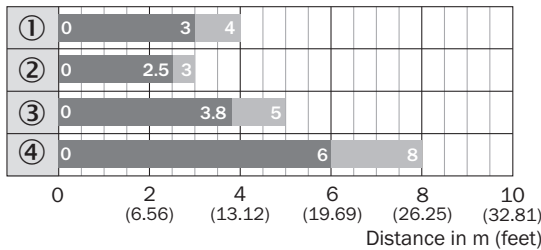

■ Sensing range      ■ Sensing range typ. max.

WLA16P-xxxx1xx

- ① PL10FH-1 reflector
- ② PL10F reflector
- ③ Reflector PL20F
- ④ Reflector P250F

**Functions**

**Operation note**

BluePilot: Blue indicator LEDs with double benefits

|  |   |
|--|---|
| <p>Easy and quick sensor alignment with the help of the LED indicator</p> <p>All blue LEDs illuminate<br/>- optimum alignment<br/>- highest possible operating reserve</p>   | <p><b>WLA photoelectric retro-reflection sensor alignment</b></p> |
| <p><b>Service note</b><br/>A reduction in sensor availability is displayed by a decrease of the blue LEDs.</p> <p>Possible causes:<br/>a) insufficient alignment<br/>b) contamination of the optical surfaces<br/>c) particles in the light beam</p> |   |

### Operation note

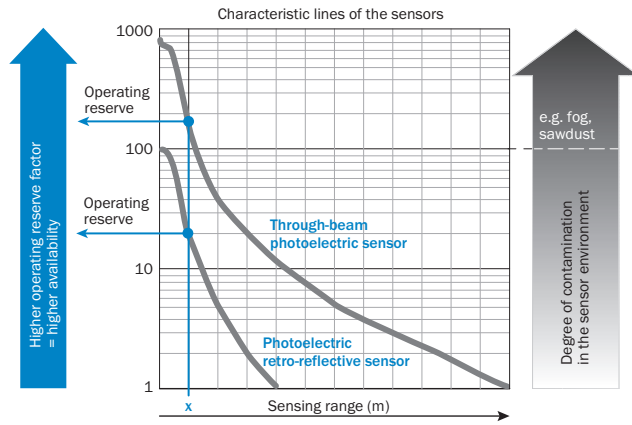

At a sensing range of „x“ the photoelectric retro-reflective and through-beam photoelectric sensors have different operating reserves (see blue arrow). The higher the operating reserve factor, the better the sensor can compensate the contamination in the air or in the light beam and on the optical surfaces (front screen, reflector), i.e. the sensor has the maximum availability, otherwise the sensor switches due to pollution although there is no object in the path of the light beam.

### Adjustments

Display and adjustment elements

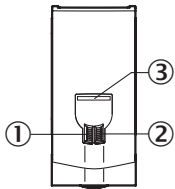

- ① LED indicator green
- ② LED indicator yellow
- ③ LED indicator blue

Dimensional drawing (Dimensions in mm (inch))

WLA16,cable

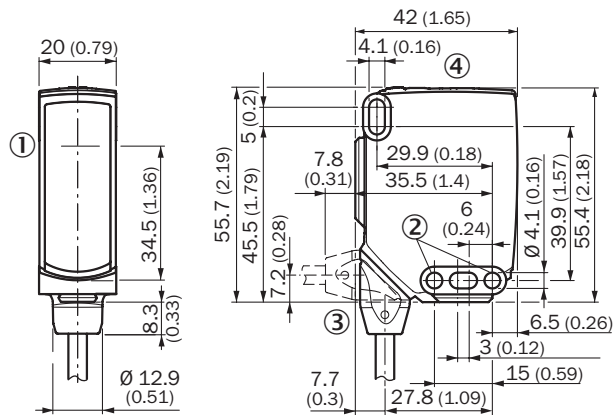

- ① Center of optical axis
- ② Mounting hole, Ø 4.1 mm
- ③ Connection
- ④ Display and adjustment elements

Recommended accessories

Other models and accessories → [www.sick.com/W16](http://www.sick.com/W16)

|                                     | Brief description   | Type        | Part no. |
|-------------------------------------|---|-------------|----------|
| <b>Universal bar clamp systems</b>  |   |             |          |
|                                     | Plate N02 for universal clamp bracket, Zinc plated steel (sheet), Zinc die cast (clamping bracket), Universal clamp (5322626), mounting hardware        | BEF-KHS-N02 | 2051608  |
| <b>Mounting brackets and plates</b> |   |             |          |
|                                     | Universal mounting bracket for reflectors, steel, zinc coated   | BEF-WN-REFX | 2064574  |
|                                     | Adapter for mounting W16 sensors in existing W14-2/W18-3 installations or L25 sensors in existing L28 installations, plastic, fastening screws included | BEF-AP-W16  | 2095677  |
| <b>Reflectors</b>                   |   |             |          |
|                                     | Rectangular, screw connection, 84 mm x 84 mm, PMMA/ABS, Screw-on, 2 hole mounting   | PL80A       | 1003865  |
| <b>Plug connectors and cables</b>   |   |             |          |
|                                     | Head A: male connector, M8, 4-pin, straight<br>Head B: -<br>Cable: unshielded   | STE-0804-G  | 6037323  |

### Recommended services

Additional services → [www.sick.com/W16](http://www.sick.com/W16)

|   | Type                   | Part no.   |
|---|------------------------|------------|
| Function Block Factory  |                        |            |
| <ul style="list-style-type: none"><li><b>Description:</b> The Function Block Factory supports common programmable logic controllers (PLCs) from various manufacturers, such as Siemens, Beckhoff, Rockwell Automation and B&amp;R. More information on the FBF can be found <a _blank"="" href="https://fbf.cloud.sick.com target=">here</a>.</li></ul> | Function Block Factory | On request |

## SICK AT A GLANCE

SICK is one of the leading manufacturers of intelligent sensors and sensor solutions for industrial applications. A unique range of products and services creates the perfect basis for controlling processes securely and efficiently, protecting individuals from accidents and preventing damage to the environment.

We have extensive experience in a wide range of industries and understand their processes and requirements. With intelligent sensors, we can deliver exactly what our customers need. In application centers in Europe, Asia and North America, system solutions are tested and optimized in accordance with customer specifications. All this makes us a reliable supplier and development partner.

Comprehensive services complete our offering: SICK LifeTime Services provide support throughout the machine life cycle and ensure safety and productivity.

For us, that is “Sensor Intelligence.”

## WORLDWIDE PRESENCE:

Contacts and other locations –[www.sick.com](http://www.sick.com)