



AFM60E-S4LA001024

AFS/AFM60 SSI

ABSOLUTE ENCODERS

SICK
Sensor Intelligence.



Ordering information

Type	Part no.
AFM60E-S4LA001024	1071500

Other models and accessories → www.sick.com/AFS_AFM60_SSI

Illustration may differ



Detailed technical data

Performance

Max. resolution (number of steps per revolution x number of revolutions)	10 bit x 12 bit (1,024 x 4,096)
Error limits G	0.2° ¹⁾
Repeatability standard deviation σ_r	0.002° ²⁾

¹⁾ In accordance with DIN ISO 1319-1, position of the upper and lower error limit depends on the installation situation, specified value refers to a symmetrical position, i.e. deviation in upper and lower direction is the same.

²⁾ In accordance with DIN ISO 55350-13; 68.3% of the measured values are inside the specified area.

Interfaces

Communication interface	SSI
Communication Interface detail	SSI + incremental HTL
Initialization time	50 ms ¹⁾
Position forming time	< 1 μ s
SSI	
Code type	Gray
Code sequence parameter adjustable	CW/CCW (V/R) parameter adjustable
Clock frequency	≤ 1 MHz ²⁾
Set (electronic adjustment)	H-active (L = 0 - 3 V, H = 4,0 - U _s V)
CW/CCW (counting sequence when turning)	L-active (L = 0 - 1,5 V, H = 2,0 - U _s V)
Incremental	
Pulses per revolution	1/4 of number of SSI steps per revolution
Output frequency	≤ 300 kHz
Load current	≤ 30 mA
Sin/Cos	
Load resistance	$\geq 120 \Omega$

¹⁾ Valid positional data can be read once this time has elapsed.

²⁾ Minimum, LOW level (Clock +): 250 ns.

Electrical data

Connection type	Male connector, M23, 12-pin, radial
Supply voltage	4.5 ... 32 V DC
Power consumption	≤ 0.7 W (without load)
Reverse polarity protection	✓
MTTFd: mean time to dangerous failure	250 years (EN ISO 13849-1) ¹⁾

¹⁾ This product is a standard product and does not constitute a safety component as defined in the Machinery Directive. Calculation based on nominal load of components, average ambient temperature 40 °C, frequency of use 8760 h/a. All electronic failures are considered hazardous. For more information, see document no. 8015532.

Mechanical data

Mechanical design	Solid shaft, face mount flange
Shaft diameter	10 mm
Wavelength	19 mm
Weight	0.3 kg ¹⁾
Shaft material	Stainless steel
Flange material	Aluminum
Housing material	Aluminum die cast
Start up torque	< 0.5 Ncm ^{2) 2)}
Operating torque	< 0.3 Ncm ^{2) 2)}
Permissible Load capacity of shaft	80 N / radial 40 N / axial
Moment of inertia of the rotor	6.2 gcm ²
Bearing lifetime	3.0 x 10 ⁹ revolutions
Angular acceleration	+ 500,000 rad/s ²
Operating speed	≤ 9,000 min ⁻¹ ³⁾

¹⁾ Relates to devices with male connector.

²⁾ At 20 °C.

³⁾ Allow for self-heating of 3.3 K per 1,000 rpm when designing the operating temperature range.

Ambient data

EMC	According to EN 61000-6-2 and EN 61000-6-3 ¹⁾
Enclosure rating	IP65, shaft side (according to IEC 60529) IP67, housing side (according to IEC 60529) ²⁾
Permissible relative humidity	90 % (condensation of the optical scanning not permitted)
Operating temperature range	0 °C ... +85 °C
Storage temperature range	-40 °C ... +100 °C, without package
Resistance to shocks	50 g, 6 ms (according to EN 60068-2-27)
Resistance to vibration	20 g, 10 Hz ... 2,000 Hz (according to EN 60068-2-6)

¹⁾ EMC according to the standards quoted is achieved if shielded cables are used.

²⁾ For devices with male connector: With mating connector mounted.

Classifications

ECl@ss 5.0	27270502
ECl@ss 5.1.4	27270502

ECl@ss 6.0	27270590
ECl@ss 6.2	27270590
ECl@ss 7.0	27270502
ECl@ss 8.0	27270502
ECl@ss 8.1	27270502
ECl@ss 9.0	27270502
ECl@ss 10.0	27270502
ECl@ss 11.0	27270502
ETIM 5.0	EC001486
ETIM 6.0	EC001486
ETIM 7.0	EC001486
UNSPSC 16.0901	41112113

Dimensional drawing (Dimensions in mm (inch))

Face mount flange, radial male connector M12 and M23

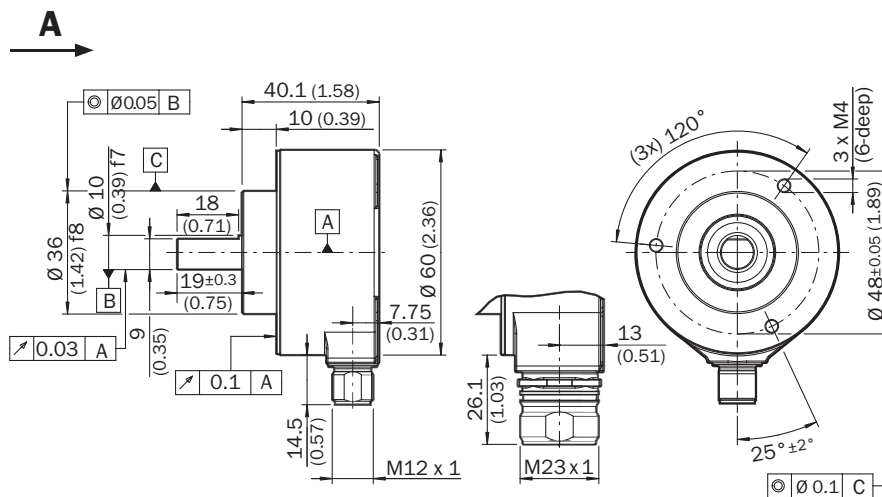

General tolerances according to DIN ISO 2768-mk

PIN assignment

M23 male connector, 12-pin and cable, 12-wire, SSI/Gray + incremental

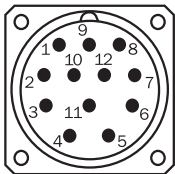

View of M23 male device connector on encoder

PIN	Wire colors (cable connection)	Signal	Explanation
1	Red	U_S	Operating voltage

PIN	Wire colors (cable connection)	Signal	Explanation
2	Blue	GND	Ground connection
3	Yellow	Clock +	Interface signals
4	White	Data +	Interface signals
5	Orange	SET	Electronic adjustment
6	Brown	Data -	Interface signals
7	Violet	Clock -	Interface signals
8	Black	\bar{B}	Signal wire
9	Orange-black	V/R	Sequence in direction of rotation
10	Green	\bar{A}	Signal wire
11	Gray	A	Signal wire
12	Pink	B	Signal wire
		Screen	Screen connected to housing on encoder side. Connected to ground on control side.

Maximum revolution range

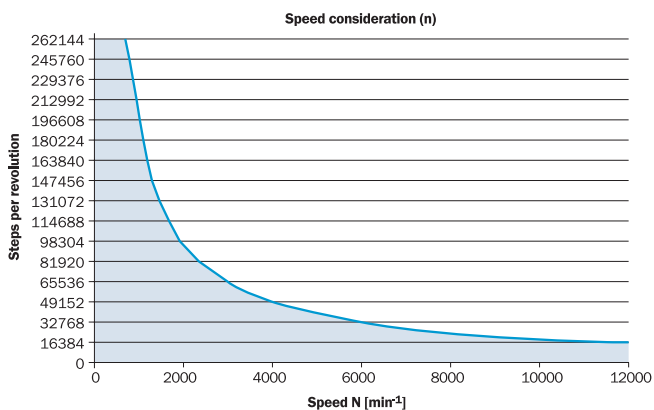

The maximum speed is also dependent on the shaft type.

Diagrams

SSI data format singleturn

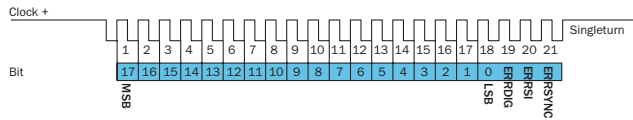

Bit 1–18: Position Bits

- LSB: Least significant Bit
- MSB: Most significant Bit

Bit 19–21: Error Bits

- ERRDIG: Failure message about speed. If this failure occurs during the position building procedure it will be indicated by the ERRDIG-Bit.
- ERRSI: Light source monitoring failure.
- ERRSYNC: Contamination of the disc or scanning system. During the determination of the position, an error has occurred since the last SSI transmission. The error bit will be deleted during the next data transmission.

The evaluation of the error bits has to be realized in the PLC.

The provided error bits don't have to be used by the PLC compulsorily.

Example

If the resolution of the absolute encoder is set on 13 bits, 16 bits are provided by the encoder: 13 data bits and 3 error bits. If the PLC is not able to evaluate the error bits, the PLC has to be set on a resolution of 13 bits. Then the error bits have to be masked out by the PLC.

SSI data format multiturn

30 Bits

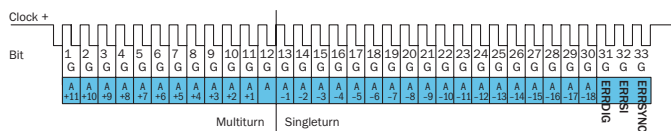

- Bit 1–12: Position Bits multiturn
- Bit 13–30: Position Bits singleturn
- Bit 31–33: Error Bits

27 Bits

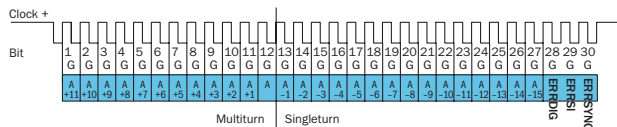

- Bit 1–12: Position Bits multiturn
- Bit 13–27: Position Bits singleturn
- Bit 28–30: Error Bits

Error Bits

- ERRDIG: Failure message about speed. If this failure occurs during the position building procedure it will be indicated by the ERRDIG-Bit.
- ERRSI: Light source monitoring failure.
- ERRSYNC: Contamination of the disc or scanning system. During the determination of the position, an error has occurred since the last SSI transmission. The error bit will be deleted during the next data transmission.

The evaluation of the error bits has to be realized in the PLC.

The provided error bits don't have to be used by the PLC compulsorily. The multiturn resolution is fixed on 12 bits.

Example

If the resolution of the absolute encoder is set on 27 bits, 30 bits are provided by the encoder: 27 data bits and 3 error bits. If the PLC is not able to evaluate the error bits, the PLC has to be set on a resolution of 27 bits. Then the error bits have to be masked out by the PLC.

Electrical interfaces sine 0.5 V_{pp}

Power supply	Output
4.5 ... 5.5 V	Sine 0.5 V _{pp}

Signal before differential generation at load 120 Ω at U_s = 5 V

Signal diagram for clockwise rotation of the shaft looking in direction "A" (shaft)

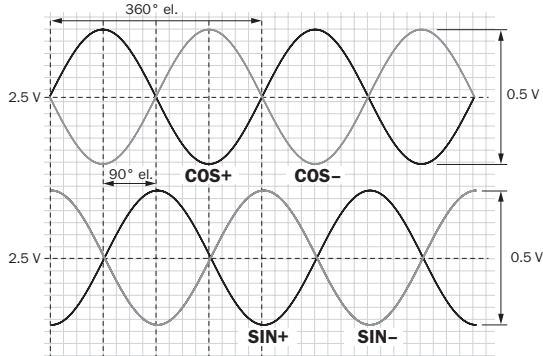

Interface signals Sin, $\overline{\text{Sin}}$, Cos, $\overline{\text{Cos}}$	Signal before differential generation at load 120 Ω	Signal offset
Analog differential	0.5 V _{pp} ± 20 %	2.5 V ± 10 %

Signal after differential generation at load 120 Ω at U_s = 5 V

Signal diagram for clockwise rotation of the shaft looking in direction "A" (shaft)

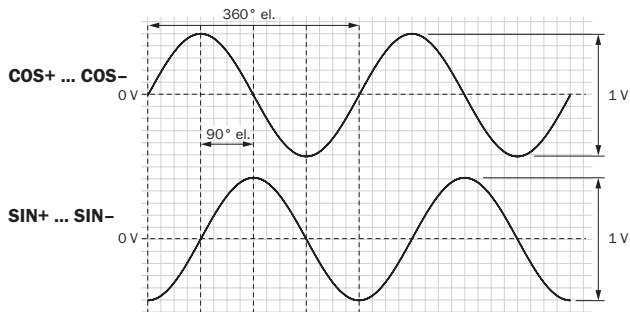





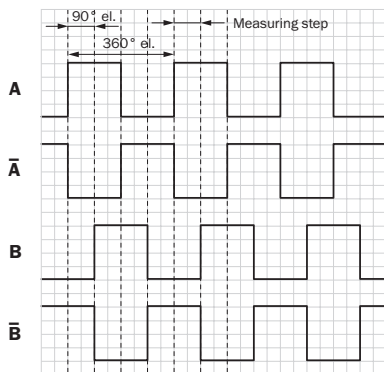





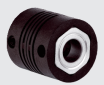

Electrical interfaces HTL/TTL

Incremental pulse diagram for clockwise rotation of the shaft looking in direction "A", see dimensional drawing



Recommended accessories

Other models and accessories → www.sick.com/AFS_AFM60_SSI

	Brief description	Type	Part no.
Flanges			
	Flange adapter, adaptation of face mount flange with 36 mm centering hub to 100 mm servo flange with 60 mm centering hub, aluminum, Aluminum	BEF-FA-036-100	2029161
Other mounting accessories			
	Servo clamps, large, for servo flanges (clamps, eccentric fastener), 3 pcs., without mounting material, without mounting hardware	BEF-WK-SF	2029166
Shaft adaptation			
	Bellows coupling, shaft diameter 6 mm / 10 mm, maximum shaft offset: radial ± 0.25 mm, axial ± 0.4 mm, angular +/- 4°; max. speed 10,000 rpm, -30 °C to +120 °C, max. torque 80 Ncm; material: stainless steel bellows, aluminum hub	KUP-0610-B	5312982
	Double loop coupling, shaft diameter 6 mm / 10 mm, max. shaft offset: radially +/- 2,5 mm, axially +/-3 mm, angle +/- 10 degrees;max. speed 3.000 rpm, -30 to +80 degrees Celsius, torsional spring stiffness of 25 Nm/rad	KUP-0610-D	5326697
	Spring washer coupling, shaft diameter 6 mm / 10 mm, Maximum shaft offset: radial +/- 0.3 mm, axial +/- 0.4 mm, angular +/- 2.5°; max. speed 12,000 rpm, -10° to +80 °C, max. torque 60 Ncm; material: aluminum flange, glass fiber-reinforced polyamide membrane and hardened steel coupling pin	KUP-0610-F	5312985
	Bar coupling, shaft diameter 6 mm / 10 mm, max. shaft offset: radial ± 0,3 mm, axial ± 0,3 mm, angular ± 3°; max. speed 10.000 rpm, -10° to +80 °C, max. torque: 80 Ncm, material: fiber-glass reinforced polyamide, aluminum hub	KUP-0610-S	2056407
	Double loop coupling, shaft diameter 8 mm / 10 mm, max. shaft offset: radially +/- 0,25 mm, axially +/-0,4 mm, angle +/- 4 degrees;max. speed 10.000 rpm, -30 to +120 degrees Celsius, torsional spring stiffness of 150 Nm/rad	KUP-0810-D	5326704
	Bar coupling, shaft diameter 8 mm / 10 mm, max. shaft offset: radial ± 0,3 mm, axial ± 0,3 mm, angular ± 3°; max. speed 10.000 rpm, -10° to +80 °C, max. torque: 80 Ncm, material: fiber-glass reinforced polyamide, aluminum hub	KUP-0810-S	5314178
	Bellows coupling, shaft diameter 10 mm/10 mm; maximum shaft offset: radial +/- 0.25 mm, axial +/- 0.4 mm, angular +/- 4°; max. revolutions 10,000 rpm, -30° to +120 °C, max. torque 80 Ncm; material: stainless steel bellows, aluminum clamping hubs	KUP-1010-B	5312983
	Double loop coupling, shaft diameter 10 mm / 10 mm, Maximum shaft offset: radial +/- 2.5 mm, axial +/- 3 mm, angular +/- 10°; max. speed 3,000 rpm, -30° to +80 °C, max. torque 1.5 Nm; material: polyurethane, galvanized steel flange	KUP-1010-D	5326703
	Spring washer coupling, shaft diameter 10 mm / 10 mm, maximum shaft offset, radial ± 0.3 mm, axial ± 0.4 mm, angle ± 2.5°, torsion spring stiffness 30 Nm/rad; material: aluminum flange, glass-fiber reinforced polyamide membrane and hardened steel coupling pin	KUP-1010-F	5312986
	Bar coupling, shaft diameter 10 mm / 10 mm; maximum shaft offset: radial ± 0.3 mm, axial ± 0.2 mm, angular ± 3°; speed 10,000 rpm, -10° to +80° Celsius, max. torque 80 Ncm; material: glass fiber-reinforced polyamide, aluminum hub	KUP-1010-S	2056408
	Spring washer coupling, shaft diameter 10 mm / 10 mm, maximum shaft offset, radial ± 0.3 mm, axial ± 0.4 mm, angle ± 2.5°, torsion spring stiffness 30 Nm/rad; material: aluminum flange, glass-fiber reinforced polyamide membrane and hardened steel coupling pin	KUP-1010-W	5319914
	10 mm / 12 mm; maximum shaft offset: radial +/- 0.25 mm, axial +/- 0.4 mm, angular +/- 4°; max. revolutions 10,000 rpm, -30° to +120 °C, max. torque 80 Ncm; material: stainless steel bellows, aluminum clamping hubs	KUP-1012-B	5312984

	Brief description	Type	Part no.
	Double loop coupling, shaft diameter 10 mm / 12 mm, Maximum shaft offset: radial +/- 2.5 mm, axial +/- 3 mm, angular +/- 10°; max. speed 3,000 rpm, -30° to +80 °C, max. torque 1.5 Nm; material: polyurethane, galvanized steel flange	KUP-1012-D	5326702
Plug connectors and cables			
	Head A: female connector, M23, 12-pin, straight Head B: Flying leads Cable: shielded, 3 m	DOL-2312-G03MMD2	2062300
	Head A: female connector, M23, 12-pin, straight Head B: Flying leads Cable: shielded, 5 m	DOL-2312-G05MMD2	2062301
	Head A: female connector, M23, 12-pin, straight Head B: Flying leads Cable: shielded, 10 m	DOL-2312-G10MMD2	2062302
	Head A: female connector, M23, 12-pin, straight Head B: Flying leads Cable: unshielded, 1.5 m	DOL-2312-G1M5MD2	2062284
	Head A: female connector, M23, 12-pin, straight Head B: Flying leads Cable: shielded, 20 m	DOL-2312-G20MMD2	2062303
	Head A: female connector, M23, 12-pin, straight Head B: Flying leads Cable: shielded, 30 m	DOL-2312-G30MMD2	2062304
	Head A: female connector, M23, 9-pin, straight Cable: HIPERFACE®, SSI, Incremental, shielded	DOS-2309-G	6028533
	Head A: female connector, M23, 12-pin, straight Head B: - Cable: HIPERFACE®, SSI, Incremental, shielded	DOS-2312-G	6027538
		DOS-2312-G02	2077057
	Head A: female connector, M23, 12-pin, angled Head B: - Cable: HIPERFACE®, SSI, Incremental, shielded	DOS-2312-W01	2072580

SICK AT A GLANCE

SICK is one of the leading manufacturers of intelligent sensors and sensor solutions for industrial applications. A unique range of products and services creates the perfect basis for controlling processes securely and efficiently, protecting individuals from accidents and preventing damage to the environment.

We have extensive experience in a wide range of industries and understand their processes and requirements. With intelligent sensors, we can deliver exactly what our customers need. In application centers in Europe, Asia and North America, system solutions are tested and optimized in accordance with customer specifications. All this makes us a reliable supplier and development partner.

Comprehensive services complete our offering: SICK LifeTime Services provide support throughout the machine life cycle and ensure safety and productivity.

For us, that is “Sensor Intelligence.”

WORLDWIDE PRESENCE:

Contacts and other locations –www.sick.com