

# AFM60E-S4AK002048

AFS/AFM60 SSI

**ABSOLUTE ENCODERS**

**SICK**  
Sensor Intelligence.



Illustration may differ



### Ordering information

Type	Part no.
AFM60E-S4AK002048	1066855

Other models and accessories → [www.sick.com/AFS\\_AFM60\\_SSI](http://www.sick.com/AFS_AFM60_SSI)

### Detailed technical data

#### Performance

<b>Max. resolution (number of steps per revolution x number of revolutions)</b>	11 bit x 12 bit (2,048 x 4,096)
<b>Error limits G</b>	0.2° <sup>1)</sup>
<b>Repeatability standard deviation <math>\sigma_r</math></b>	0.002° <sup>2)</sup>

<sup>1)</sup> In accordance with DIN ISO 1319-1, position of the upper and lower error limit depends on the installation situation, specified value refers to a symmetrical position, i.e. deviation in upper and lower direction is the same.

<sup>2)</sup> In accordance with DIN ISO 55350-13; 68.3% of the measured values are inside the specified area.

#### Interfaces

<b>Communication interface</b>	SSI
<b>Initialization time</b>	50 ms <sup>1)</sup>
<b>Position forming time</b>	< 1 $\mu$ s
<b>SSI</b>	
Code type	Gray
Code sequence parameter adjustable	CW/CCW (V/R) parameter adjustable
Clock frequency	$\leq 1$ MHz <sup>2)</sup>
Set (electronic adjustment)	H-active (L = 0 - 3 V, H = 4,0 - U <sub>s</sub> V)
CW/CCW (counting sequence when turning)	L-active (L = 0 - 1,5 V, H = 2,0 - U <sub>s</sub> V)
<b>Sin/Cos</b>	
Load resistance	$\geq 120 \Omega$

<sup>1)</sup> Valid positional data can be read once this time has elapsed.

<sup>2)</sup> Minimum, LOW level (Clock +): 250 ns.

#### Electrical data

<b>Connection type</b>	Cable, 8-wire, universal, 1.5 m <sup>1)</sup>
<b>Supply voltage</b>	4.5 ... 32 V DC
<b>Power consumption</b>	$\leq 0.7$ W (without load)
<b>Reverse polarity protection</b>	✓

<sup>1)</sup> The universal cable connection is positioned so that it is possible to lay it without bends in a radial or axial direction.

<sup>2)</sup> This product is a standard product and does not constitute a safety component as defined in the Machinery Directive. Calculation based on nominal load of components, average ambient temperature 40°C, frequency of use 8760 h/a. All electronic failures are considered hazardous. For more information, see document no. 8015532.

<b>MTTFd: mean time to dangerous failure</b>	250 years (EN ISO 13849-1) <sup>2)</sup>
--	--

<sup>1)</sup> The universal cable connection is positioned so that it is possible to lay it without bends in a radial or axial direction.

<sup>2)</sup> This product is a standard product and does not constitute a safety component as defined in the Machinery Directive. Calculation based on nominal load of components, average ambient temperature 40 °C, frequency of use 8760 h/a. All electronic failures are considered hazardous. For more information, see document no. 8015532.

## Mechanical data

<b>Mechanical design</b>	Solid shaft, face mount flange
<b>Shaft diameter</b>	10 mm
<b>Wavelength</b>	19 mm
<b>Weight</b>	0.3 kg <sup>1)</sup>
<b>Shaft material</b>	Stainless steel
<b>Flange material</b>	Aluminum
<b>Housing material</b>	Aluminum die cast
<b>Start up torque</b>	< 0.5 Ncm <sup>2)</sup> <sup>2)</sup>
<b>Operating torque</b>	< 0.3 Ncm <sup>2)</sup> <sup>2)</sup>
<b>Permissible Load capacity of shaft</b>	80 N / radial 40 N / axial
<b>Moment of inertia of the rotor</b>	6.2 gcm <sup>2</sup>
<b>Bearing lifetime</b>	3.0 x 10 <sup>9</sup> revolutions
<b>Angular acceleration</b>	+ 500,000 rad/s <sup>2</sup>
<b>Operating speed</b>	≤ 9,000 min <sup>-1</sup> <sup>3)</sup>

<sup>1)</sup> Relates to devices with male connector.

<sup>2)</sup> At 20 °C.

<sup>3)</sup> Allow for self-heating of 3.3 K per 1,000 rpm when designing the operating temperature range.

## Ambient data

<b>EMC</b>	According to EN 61000-6-2 and EN 61000-6-3 <sup>1)</sup>
<b>Enclosure rating</b>	IP65, shaft side (according to IEC 60529) IP67, housing side (according to IEC 60529) <sup>2)</sup>
<b>Permissible relative humidity</b>	90 % (condensation of the optical scanning not permitted)
<b>Operating temperature range</b>	0 °C ... +85 °C
<b>Storage temperature range</b>	-40 °C ... +100 °C, without package
<b>Resistance to shocks</b>	50 g, 6 ms (according to EN 60068-2-27)
<b>Resistance to vibration</b>	20 g, 10 Hz ... 2,000 Hz (according to EN 60068-2-6)

<sup>1)</sup> EMC according to the standards quoted is achieved if shielded cables are used.

<sup>2)</sup> For devices with male connector: With mating connector mounted.

## Classifications

<b>ECl@ss 5.0</b>	27270502
<b>ECl@ss 5.1.4</b>	27270502
<b>ECl@ss 6.0</b>	27270590
<b>ECl@ss 6.2</b>	27270590
<b>ECl@ss 7.0</b>	27270502
<b>ECl@ss 8.0</b>	27270502

<b>ECl@ss 8.1</b>	27270502
<b>ECl@ss 9.0</b>	27270502
<b>ECl@ss 10.0</b>	27270502
<b>ECl@ss 11.0</b>	27270502
<b>ETIM 5.0</b>	EC001486
<b>ETIM 6.0</b>	EC001486
<b>ETIM 7.0</b>	EC001486
<b>UNSPSC 16.0901</b>	41112113

### Dimensional drawing (Dimensions in mm (inch))

Face mount flange, cable connection

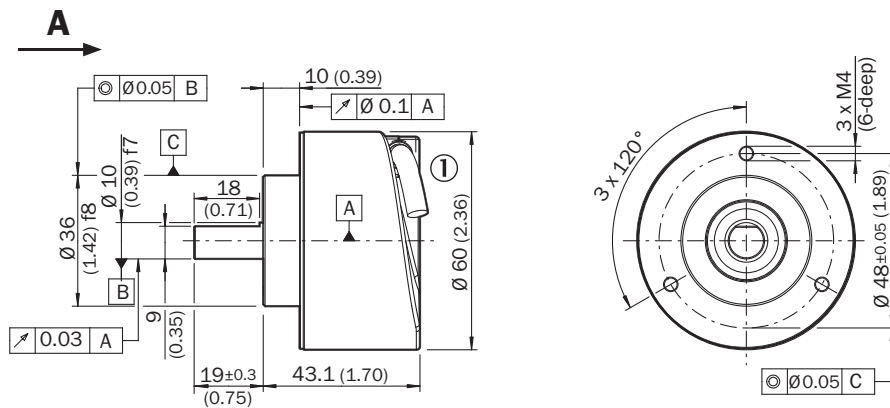

General tolerances according to DIN ISO 2768-mk

① Cable diameter = 5.6 mm +/- 0.2 mm bend radius = 30 mm

### PIN assignment

M12 male connector, 8-pin and cable, 8-wire, SSI/Gray

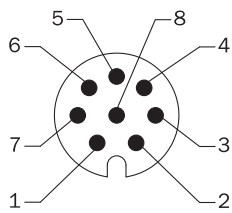

View of M12 male device connector on encoder

## Maximum revolution range

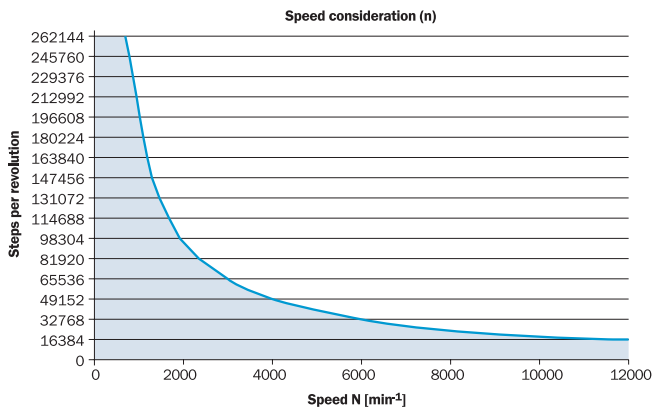

The maximum speed is also dependent on the shaft type.

Diagrams

SSI data format singleturn

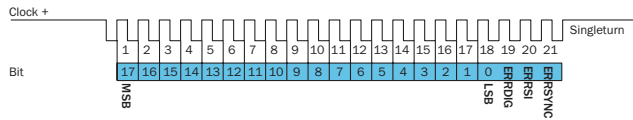

**Bit 1–18: Position Bits**

- LSB: Least significant Bit
- MSB: Most significant Bit

**Bit 19–21: Error Bits**

- ERRDIG: Failure message about speed. If this failure occurs during the position building procedure it will be indicated by the ERRDIG-Bit.
- ERRSI: Light source monitoring failure.
- ERRSYNC: Contamination of the disc or scanning system. During the determination of the position, an error has occurred since the last SSI transmission. The error bit will be deleted during the next data transmission.

**The evaluation of the error bits has to be realized in the PLC.**

The provided error bits don't have to be used by the PLC compulsorily.

**Example**

If the resolution of the absolute encoder is set on 13 bits, 16 bits are provided by the encoder: 13 data bits and 3 error bits. If the PLC is not able to evaluate the error bits, the PLC has to be set on a resolution of 13 bits. Then the error bits have to be masked out by the PLC.

SSI data format multiturn

**30 Bits**

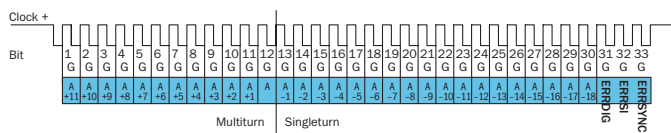

- Bit 1–12:** Position Bits multiturn
- Bit 13–30:** Position Bits singleturn
- Bit 31–33:** Error Bits

**27 Bits**

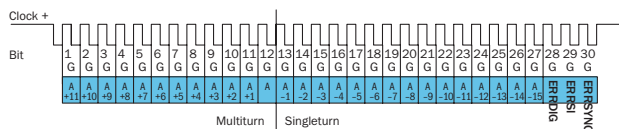

- Bit 1–12:** Position Bits multiturn
- Bit 13–27:** Position Bits singleturn
- Bit 28–30:** Error Bits

**Error Bits**

- ERRDIG: Failure message about speed. If this failure occurs during the position building procedure it will be indicated by the ERRDIG-Bit.
- ERRSI: Light source monitoring failure.
- ERRSYNC: Contamination of the disc or scanning system. During the determination of the position, an error has occurred since the last SSI transmission. The error bit will be deleted during the next data transmission.

**The evaluation of the error bits has to be realized in the PLC.**

The provided error bits don't have to be used by the PLC compulsorily. The multiturn resolution is fixed on 12 bits.

**Example**

If the resolution of the absolute encoder is set on 27 bits, 30 bits are provided by the encoder: 27 data bits and 3 error bits. If the PLC is not able to evaluate the error bits, the PLC has to be set on a resolution of 27 bits. Then the error bits have to be masked out by the PLC.

**Electrical interfaces sine 0.5 V<sub>pp</sub>**

Power supply	Output
4.5 ... 5.5 V	Sine 0.5 V <sub>pp</sub>

Signal before differential generation at load 120 Ω at U<sub>s</sub> = 5 V

Signal diagram for clockwise rotation of the shaft looking in direction "A" (shaft)

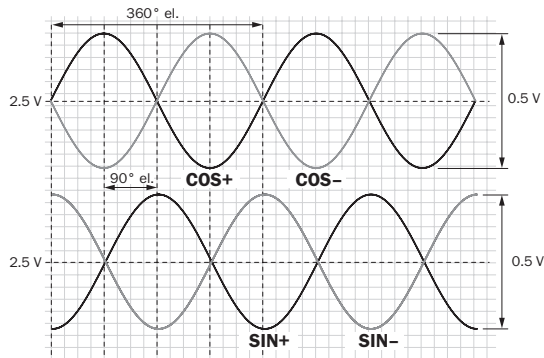

Interface signals Sin, $\overline{\text{Sin}}$ , Cos, $\overline{\text{Cos}}$	Signal before differential generation at load 120 Ω	Signal offset
Analog differential	0.5 V <sub>pp</sub> ± 20 %	2.5 V ± 10 %

Signal after differential generation at load 120 Ω at U<sub>s</sub> = 5 V

Signal diagram for clockwise rotation of the shaft looking in direction "A" (shaft)

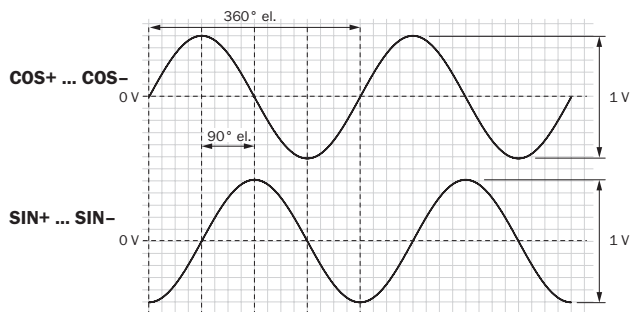





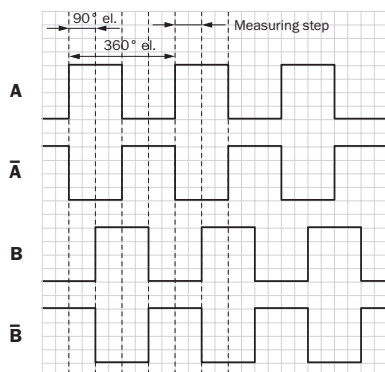





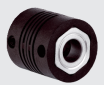

**Electrical interfaces HTL/TTL**

Incremental pulse diagram for clockwise rotation of the shaft looking in direction "A", see dimensional drawing







### Recommended accessories

Other models and accessories → [www.sick.com/AFS\\_AFM60\\_SSI](http://www.sick.com/AFS_AFM60_SSI)

	Brief description	Type	Part no.
<b>Flanges</b>			
	Flange adapter, adaptation of face mount flange with 36 mm centering hub to 100 mm servo flange with 60 mm centering hub, aluminum, Aluminum	BEF-FA-036-100	2029161
<b>Other mounting accessories</b>			
	Servo clamps, large, for servo flanges (clamps, eccentric fastener), 3 pcs., without mounting material, without mounting hardware	BEF-WK-SF	2029166
<b>Shaft adaptation</b>			
	Bellows coupling, shaft diameter 6 mm / 10 mm, maximum shaft offset: radial ± 0.25 mm, axial ± 0.4 mm, angular +/- 4°; max. speed 10,000 rpm, -30 °C to +120 °C, max. torque 80 Ncm; material: stainless steel bellows, aluminum hub	KUP-0610-B	5312982
	Double loop coupling, shaft diameter 6 mm / 10 mm, max. shaft offset: radially +/- 2,5 mm, axially +/-3 mm, angle +/- 10 degrees;max. speed 3.000 rpm, -30 to +80 degrees Celsius, torsional spring stiffness of 25 Nm/rad	KUP-0610-D	5326697
	Spring washer coupling, shaft diameter 6 mm / 10 mm, Maximum shaft offset: radial +/- 0.3 mm, axial +/- 0.4 mm, angular +/- 2.5°; max. speed 12,000 rpm, -10° to +80 °C, max. torque 60 Ncm; material: aluminum flange, glass fiber-reinforced polyamide membrane and hardened steel coupling pin	KUP-0610-F	5312985
	Bar coupling, shaft diameter 6 mm / 10 mm, max. shaft offset: radial ± 0,3 mm, axial ± 0,3 mm, angular ± 3°; max. speed 10.000 rpm, -10° to +80 °C, max. torque: 80 Ncm, material: fiber-glass reinforced polyamide, aluminum hub	KUP-0610-S	2056407
	Double loop coupling, shaft diameter 8 mm / 10 mm, max. shaft offset: radially +/- 0,25 mm, axially +/-0,4 mm, angle +/- 4 degrees;max. speed 10.000 rpm, -30 to +120 degrees Celsius, torsional spring stiffness of 150 Nm/rad	KUP-0810-D	5326704
	Bar coupling, shaft diameter 8 mm / 10 mm, max. shaft offset: radial ± 0,3 mm, axial ± 0,3 mm, angular ± 3°; max. speed 10.000 rpm, -10° to +80 °C, max. torque: 80 Ncm, material: fiber-glass reinforced polyamide, aluminum hub	KUP-0810-S	5314178
	Bellows coupling, shaft diameter 10 mm/10 mm; maximum shaft offset: radial +/- 0.25 mm, axial +/- 0.4 mm, angular +/- 4°; max. revolutions 10,000 rpm, -30° to +120 °C, max. torque 80 Ncm; material: stainless steel bellows, aluminum clamping hubs	KUP-1010-B	5312983
	Double loop coupling, shaft diameter 10 mm / 10 mm, Maximum shaft offset: radial +/- 2.5 mm, axial +/- 3 mm, angular +/- 10°; max. speed 3,000 rpm, -30° to +80 °C, max. torque 1.5 Nm; material: polyurethane, galvanized steel flange	KUP-1010-D	5326703
	Spring washer coupling, shaft diameter 10 mm / 10 mm, maximum shaft offset, radial ± 0.3 mm, axial ± 0.4 mm, angle ± 2.5°, torsion spring stiffness 30 Nm/rad; material: aluminum flange, glass-fiber reinforced polyamide membrane and hardened steel coupling pin	KUP-1010-F	5312986
	Bar coupling, shaft diameter 10 mm / 10 mm; maximum shaft offset: radial ± 0.3 mm, axial ± 0.2 mm, angular ± 3°; speed 10,000 rpm, -10° to +80° Celsius, max. torque 80 Ncm; material: glass fiber-reinforced polyamide, aluminum hub	KUP-1010-S	2056408
	Spring washer coupling, shaft diameter 10 mm / 10 mm, maximum shaft offset, radial ± 0.3 mm, axial ± 0.4 mm, angle ± 2.5°, torsion spring stiffness 30 Nm/rad; material: aluminum flange, glass-fiber reinforced polyamide membrane and hardened steel coupling pin	KUP-1010-W	5319914
	10 mm / 12 mm; maximum shaft offset: radial +/- 0.25 mm, axial +/- 0.4 mm, angular +/- 4°; max. revolutions 10,000 rpm, -30° to +120 °C, max. torque 80 Ncm; material: stainless steel bellows, aluminum clamping hubs	KUP-1012-B	5312984



	Brief description	Type	Part no.
	Double loop coupling, shaft diameter 10 mm / 12 mm, Maximum shaft offset: radial +/- 2.5 mm, axial +/- 3 mm, angular +/- 10°; max. speed 3,000 rpm, -30° to +80 °C, max. torque 1.5 Nm; material: polyurethane, galvanized steel flange	KUP-1012-D	5326702
Plug connectors and cables			
	Head A: male connector, M12, 8-pin, straight, A-coded Head B: - Cable: Incremental, shielded	STE-1208-GA01	6044892
	Head A: male connector, M23, 12-pin, straight Head B: - Cable: HIPERFACE®, SSI, Incremental, RS-422, shielded	STE-2312-G	6027537
	Head A: male connector, M23, 12-pin, straight Head B: - Cable: HIPERFACE®, SSI, Incremental, shielded	STE-2312-G01	2077273
		STE-2312-GX	6028548

## SICK AT A GLANCE

SICK is one of the leading manufacturers of intelligent sensors and sensor solutions for industrial applications. A unique range of products and services creates the perfect basis for controlling processes securely and efficiently, protecting individuals from accidents and preventing damage to the environment.

We have extensive experience in a wide range of industries and understand their processes and requirements. With intelligent sensors, we can deliver exactly what our customers need. In application centers in Europe, Asia and North America, system solutions are tested and optimized in accordance with customer specifications. All this makes us a reliable supplier and development partner.

Comprehensive services complete our offering: SICK LifeTime Services provide support throughout the machine life cycle and ensure safety and productivity.

For us, that is “Sensor Intelligence.”

## WORLDWIDE PRESENCE:

Contacts and other locations –[www.sick.com](http://www.sick.com)