



HSE18L-B4A5AA

SureSense

HYBRID PHOTOELECTRIC SENSORS

SICK
Sensor Intelligence.



Ordering information

| Type | Part no. |
|---------------|----------|
| HSE18L-B4A5AA | 1071029 |

Other models and accessories → www.sick.com/SureSense

Illustration may differ



Detailed technical data

Features

| | |
|--|-------------------------------------|
| Device version | Standard |
| Sensor/ detection principle | Through-beam photoelectric sensor |
| Dimensions (W x H x D) | 16.2 mm x 48.5 mm x 31.8 mm |
| Housing design (light emission) | Hybrid |
| Thread diameter (housing) | M18 |
| Mounting system type | M18, nose / side (24.1 ... 25.4 mm) |
| Housing color | Blue |
| Sensing range max. | 0 m ... 60 m |
| Sensing range | 0 m ... 50 m |
| Type of light | Visible red light |
| Light source | Laser ^{1) 2)} |
| Light spot size (distance) | 2 mm (1.5 m) |
| Wave length | 655 nm |
| Laser class | I |
| Adjustment | |
| | Potentiometer, right None |
| | Potentiometer, left None |
| Special applications | Detecting small objects |
| Special features | - |

¹⁾ Average service life: 50,000 h at T_U = +25 °C.

²⁾ CLASS 1 LASER PRODUCT EN60825-1:2014, IEC60825-1:2014, Maximum pulse power < 2.5 mW, Pulse length: 4 μs, Wavelength: 650 ... 670 nm, Complies with 21 CFR 1040.10 and 1040.11 except for deviations pursuant to Laser Notice No. 50, dated June 24, 2007.

Mechanics/electronics

| | |
|--|--|
| Supply voltage | 10 V DC ... 30 V DC |
| Ripple | < 5 V _{pp} ¹⁾ |
| Current consumption | 20 mA ²⁾ |
| Switching output | PNP NPN |
| Switching mode | Light switching |
| Switching output detail | |
| Switching output Q1 | PNP, Light switching |
| Switching output Q2 | NPN, Light switching |
| Output current I_{max.} | ≤ 100 mA |
| Response time | ≤ 0.5 ms ³⁾ |
| Switching frequency | 1,000 Hz ⁴⁾ |
| Connection type | Male connector M12, 4-pin |
| Circuit protection | A ⁵⁾ B ⁶⁾ D ⁷⁾ |
| Protection class | III |
| Weight | 18 g |
| Housing material | Plastic, VISTAL® |
| Optics material | Plastic, PMMA |
| Enclosure rating | IP67 IP69K |
| Items supplied | Mounting nut (1x), M18, plastic, black, flat |
| EMC | EN 60947-5-2 (The sensor complies with the Radio Safety Requirements (EMC) for the industrial sector (Radio Safety Class A). It may cause radio interference if used in a residential area.) |
| Ambient operating temperature | -30 °C ... +55 °C ⁸⁾ |
| Ambient storage temperature | -40 °C ... +70 °C |
| UL File No. | E189383 |

1) May not exceed or fall below U_v tolerances.

2) Without signal strength light bar and load.

3) Signal transit time with resistive load.

4) With light/dark ratio 1:1.

5) A = V_S connections reverse-polarity protected.

6) B = inputs and output reverse-polarity protected.

7) D = outputs overcurrent and short-circuit protected.

8) Below Ta = -10 °C, sensor must be turned on at Ta > -10 °C. Sensor cannot be turned on below Ta = -10 °C.

Classifications

| | |
|---------------------|----------|
| ECl@ss 5.0 | 27270901 |
| ECl@ss 5.1.4 | 27270901 |
| ECl@ss 6.0 | 27270901 |
| ECl@ss 6.2 | 27270901 |
| ECl@ss 7.0 | 27270901 |
| ECl@ss 8.0 | 27270901 |

| | |
|-----------------------|----------|
| ECl@ss 8.1 | 27270901 |
| ECl@ss 9.0 | 27270901 |
| ECl@ss 10.0 | 27270901 |
| ECl@ss 11.0 | 27270901 |
| ETIM 5.0 | EC002716 |
| ETIM 6.0 | EC002716 |
| ETIM 7.0 | EC002716 |
| UNSPSC 16.0901 | 39121528 |

Connection/PIN assignment

| | | | | | | | | | |
|--|---|------|--------|------|----------------|------|-------|------|--------------------|
| Connection type | Male connector M12, 4-pin | | | | | | | | |
| Pin assignment_{sender} | <table border="0"> <tr> <td>BN 1</td> <td>+ (L+)</td> </tr> <tr> <td>WH 2</td> <td>Not connected</td> </tr> <tr> <td>BU 3</td> <td>- (M)</td> </tr> <tr> <td>BK 4</td> <td>Test _{IN}</td> </tr> </table> | BN 1 | + (L+) | WH 2 | Not connected | BU 3 | - (M) | BK 4 | Test _{IN} |
| BN 1 | + (L+) | | | | | | | | |
| WH 2 | Not connected | | | | | | | | |
| BU 3 | - (M) | | | | | | | | |
| BK 4 | Test _{IN} | | | | | | | | |
| Pin assignment_{receiver} | <table border="0"> <tr> <td>BN 1</td> <td>+ (L+)</td> </tr> <tr> <td>WH 2</td> <td>Q₂</td> </tr> <tr> <td>BU 3</td> <td>- (M)</td> </tr> <tr> <td>BK 4</td> <td>Q₁</td> </tr> </table> | BN 1 | + (L+) | WH 2 | Q ₂ | BU 3 | - (M) | BK 4 | Q ₁ |
| BN 1 | + (L+) | | | | | | | | |
| WH 2 | Q ₂ | | | | | | | | |
| BU 3 | - (M) | | | | | | | | |
| BK 4 | Q ₁ | | | | | | | | |

Dimensional drawing (Dimensions in mm (inch))

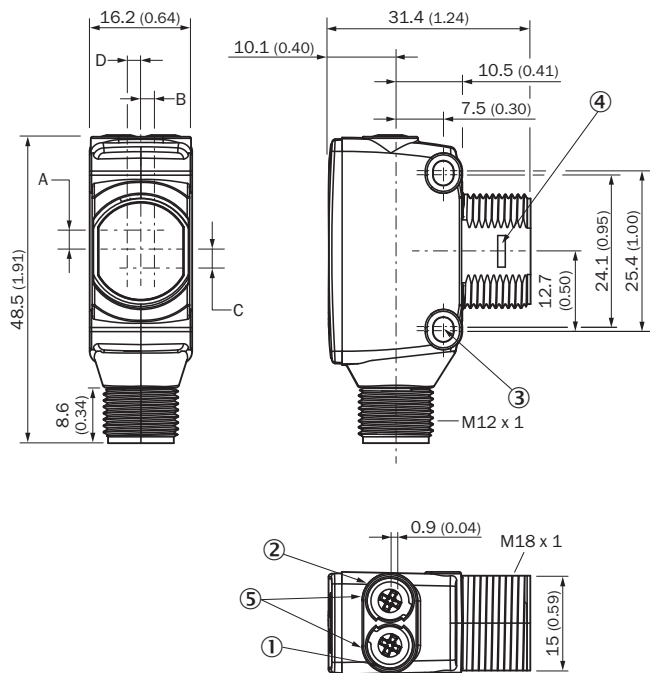

- ① LED indicator yellow: Status of received light beam
- ② LED indicator green: power on
- ③ M3 mounting hole
- ④ Snap Connection for flush ring (sold separately)
- ⑤ Potentiometer (if selected) or LED Indicators

| Dimensions in mm (inch) | Receiver | | Sender | |
|---|--------------|------------|------------|------------|
| | A | B | C | D |
| HTB18 / HTF18 | - 1.1 (0.04) | 1.1 (0.04) | 4.7 (0.19) | 0.6 (0.02) |
| HTE18 / HL18 / HSE18 | 2.5 (0.1) | 0.0 (0.0) | 4.0 (0.16) | 0.0 (0.0) |
| HTB18L / HTF18L / HL18L / HSE18L | 2.5 (0.1) | 0.0 (0.0) | 3.5 (0.14) | 0.0 (0.0) |

Connection type

See table: Connection/PIN assignment

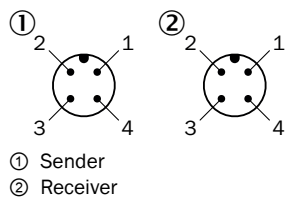

Characteristic curve

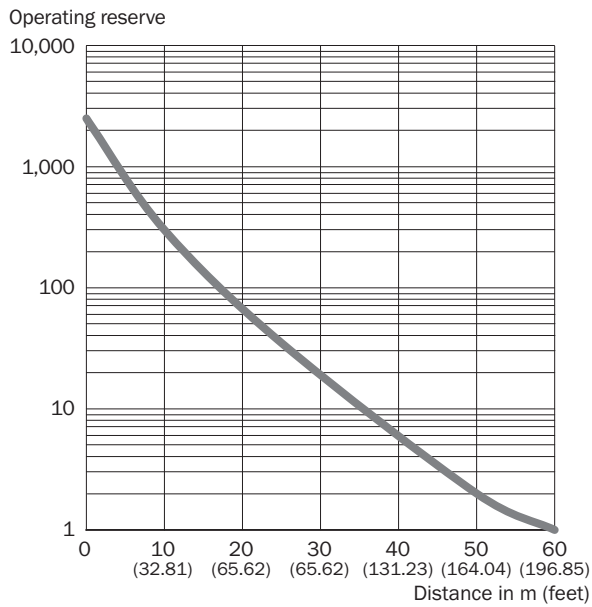

Light spot size

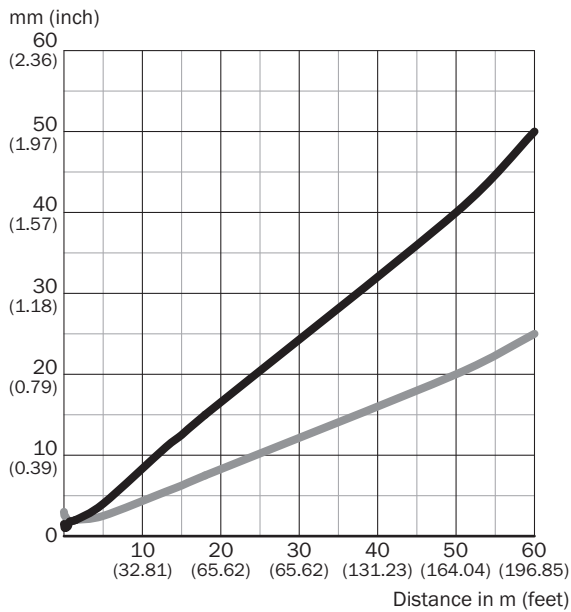

Dimensions in mm (inch)

| Sensing range | Vertical | Horizontal |
|------------------------------|----------------|----------------|
| 0.3 m (0.98 feet) | 1.2 (0.05) | 2.2 (0.09) |
| 1.5 m (4.92 feet) | 2.0 (0.08) | 2.0 (0.08) |
| 18 m (59.06 feet) | 15.0 (0.59) | 7.5 (0.30) |
| 60 m (196.85 feet) | 50.0 (1.97) | 25.0 (0.98) |

— Vertical
— Horizontal

Sensing range diagram

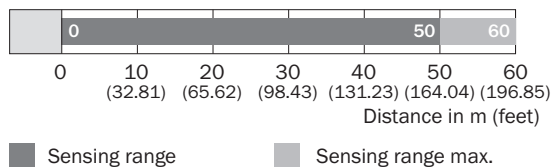

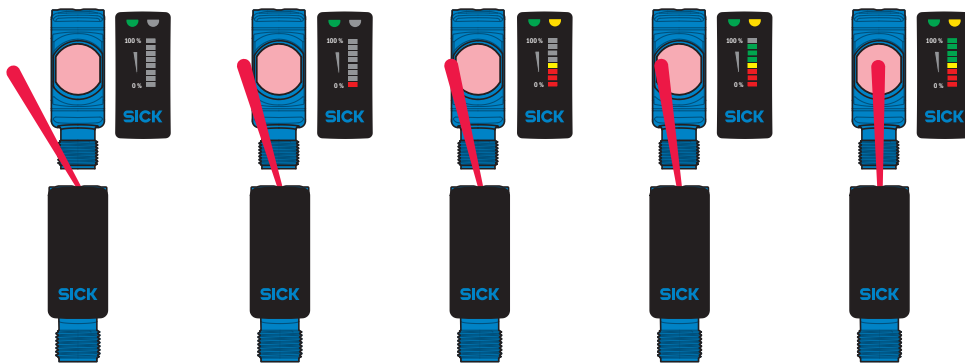

Functions



Recommended accessories

Other models and accessories → www.sick.com/SureSense

| | Brief description | Type | Part no. |
|---|---|--------------------|----------|
| Plug connectors and cables | | | |
|  | Head A: female connector, M12, 4-pin, straight, A-coded Head B: Flying leads Cable: Sensor/actuator cable, PVC, unshielded, 5 m | YF2A14-050VB3XLEAX | 2096235 |
|  | Head A: male connector, M12, 4-pin, straight Head B: - Cable: unshielded | STE-1204-G | 6009932 |

SICK AT A GLANCE

SICK is one of the leading manufacturers of intelligent sensors and sensor solutions for industrial applications. A unique range of products and services creates the perfect basis for controlling processes securely and efficiently, protecting individuals from accidents and preventing damage to the environment.

We have extensive experience in a wide range of industries and understand their processes and requirements. With intelligent sensors, we can deliver exactly what our customers need. In application centers in Europe, Asia and North America, system solutions are tested and optimized in accordance with customer specifications. All this makes us a reliable supplier and development partner.

Comprehensive services complete our offering: SICK LifeTime Services provide support throughout the machine life cycle and ensure safety and productivity.

For us, that is “Sensor Intelligence.”

WORLDWIDE PRESENCE:

Contacts and other locations –www.sick.com