

**Temperature measurement
accessories compression fittings
CF-M-3-N1/8-A4**

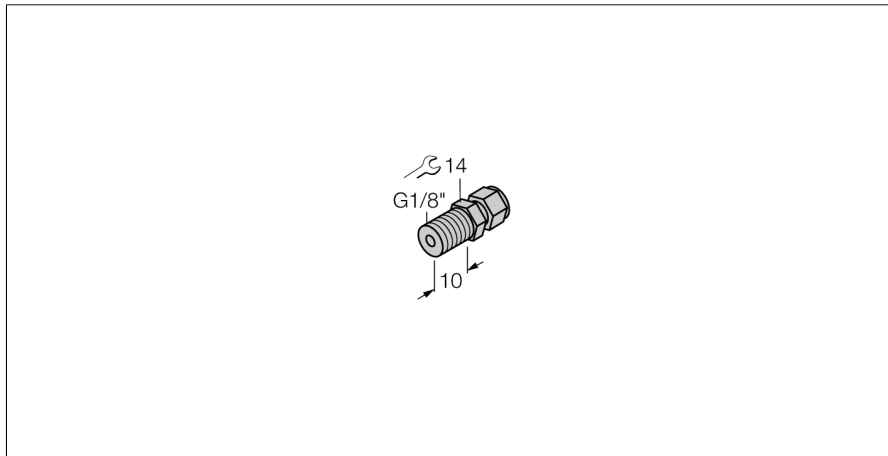

- Compression fittings for direct mounting of TP temperature probes
- Temperature range -50...+350 °C

General description

With compression fittings, probes can be mounted directly where they are needed and they can be immersed as deep as wanted. Through direct contact with the medium, they react immediately to temperature changes.

Type code	CF-M-3-N1/8-A4
Ident no.	9910406
Temperature range	-50...350 °C
Temperature operating range	-58...662°F
Pressure resistance	100 bar
Housing	
Housing material	stainless steel, V4A (1.4404)
Sealing material	stainless steel
Process connection	NPT 1/8"
Pressure resistance	100 bar
Max. tightening torque housing nut	100 Nm