

**Temperature measurement  
Accessories thermowell  
THW-3-G1/8-A4-L100**

- Thermowell for mounting TS203 probes
- Process connection G1/8" male thread

**General description**

Thermowells are used for unpressurized mounting of probes. They protect the probes against direct contact with the medium. The probe can be replaced without interrupting the process.

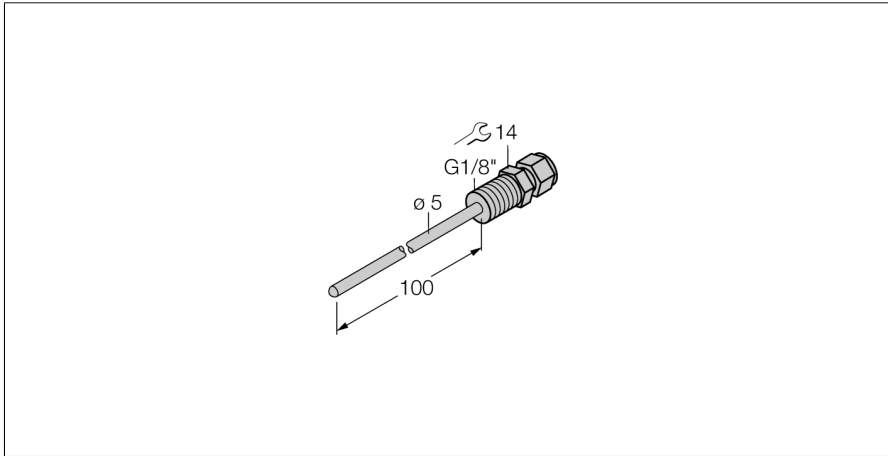

<b>Type code</b>	THW-3-G1/8-A4-L100
Ident no.	9910417
<b>Temperature range</b>	-50...350 °C
Temperature operating range	-58...662 °F
Immersion depth (L)	100 mm
<b>Pressure resistance</b>	400 bar
<b>Housing</b>	
Housing material	stainless steel 1.4404 (AISI 316L), V4A (1.4404)
Sealing material	stainless steel
Process connection	G 1/8" male thread
Pressure resistance	400 bar
Max. tightening torque housing nut	100 Nm