

Rotative measurement
Absolute rotary encoder / Multiturn
RM-29S6S-9A28B-R3M12

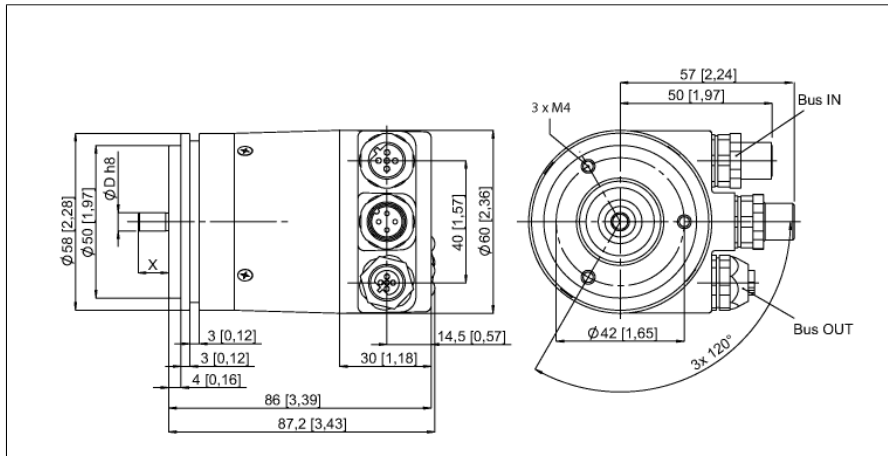

- Synchro flange, Ø 58 mm
- Solid shaft, Ø 6mm x 10mm
- Optical measuring principle
- Shaft material, stainless steel
- Protection class IP67 on the shaft side
- -40...+80°C
- max. 3000 rev/min
- PROFIBUS
- Removable bus cover with male connector, 3 x M12
- Singleturn, scalable to 16 bit (default 13 bit)
- Multiturn, 12 bit resolution

Type code	RM-29S6S-9A28B-R3M12
Ident no.	1544417
Measuring principle	Photoelectric
max. Drehzahl	3.000 U/min
Moment of inertia of the rotor	4 x10 ⁻⁶ kgm ²
Starting torque	0.01 Nm
Ambient temperature	-40...+80 °C
Operating voltage	10...30VDC
No-load current I ₀	≤ 120 mA
Output function	6-wire, PROFIBUS
Output type	absolute multiturn
Resolution single-turn	16 Bit
Resolution multiturn	12 Bit
	single-turn scalable
Design	Solid shaft
Flange type	Synchro flange
Flange diameter	58 mm
Shaft type	Shaft
Shaft diameter D	6 mm
Shaft length X	10 mm
Shaft material	Stainless steel
Housing material	zinc, die-casting
Connection	bus connection
	3 x M12
Axial shaft load	40 N
Radial shaft load	80 N
Vibration resistance (EN 60068-2-6)	100 m/s ² , 55...2000 Hz
Shock resistance (EN 60068-2-27)	2500 m/s ² , 6 ms
Protection class housing	IP67
Protection class shaft	IP67

**Rotative measurement
Absolute rotary encoder / Multiturn
RM-29S6S-9A28B-R3M12****Pin configuration**

Signal	Port A TxD+	Port A RxD+	Port A TxD-	Port A RxD-	Port B TxD+	Port B RxD+	Port B TxD-	Port B RxD-	-
Signal -Pin	BUS in 2	BUS in 4	BUS in 5	BUS out 1	BUS out 2	BUS out 3	BUS out 4	BUS out 5	-
Power	U_s	-	0V	-	-	-	-	-	-
Power- Pin	1	2	3	4	5	-	-	-	-

Rotative measurement
Absolute rotary encoder / Multiturn
RM-29S6S-9A28B-R3M12

Accessories

Type code	Ident no.	Description	Dimension drawing
RFA-2	1544631	Aluminium flange adapter, rectangular, for solid shaft encoders with clamping flange; edge length 63.5mm; 3mm thick	
RFA-4	1544633	Euro flange – aluminium flange adapter for solid shaft encoders, Ø 115 mm; reference diameter 100 mm; adapts 58 mm clamping flange to Euro flange	
RFA-6	1544635	Aluminium flange adapter for solid shaft encoders with clamping flange, Ø 58 mm; adapts clamping flange to synchro flange	
RFA-7	1544636	Aluminium flange adapter for solid shaft encoders, Ø 65 mm; adapts to Ø 65 mm flange and 48 mm reference diameter	
RFA-8	1544637	Aluminium flange adapter for solid shaft encoders with clamping flange, Ø 70 mm; thickness 4 mm, adapts to Ø 70 mm flange	

Rotative measurement
Absolute rotary encoder / Multiturn
RM-29S6S-9A28B-R3M12

Accessories

Type code	Ident no.	Description	Dimension drawing
RFA-9	1544638	Aluminium angle flange for solid shaft encoders with Ø 58 mm clamping flange	
RFA-11	1544640	Aluminium flange adapter for solid shaft encoders with clamping flange, Ø 70 mm; thickness 10mm, adapts to Ø 70 mm flange	
RFA-12	1544641	Aluminium flange adapter, rectangular, for solid shaft encoders with clamping flange; edge length 70mm; 10mm thick	
RFA-13	1544642	Aluminium flange adapter, rectangular, for solid shaft encoders with clamping flange; edge length 80mm; 4 mm thick	
RFA-1	1544630	Aluminium flange adapter, rectangular, for solid shaft encoders with clamping flange; edge length 58 mm; 4 mm thick	

Rotative measurement
Absolute rotary encoder / Multiturn
RM-29S6S-9A28B-R3M12

Accessories

Type code	Ident no.	Description	Dimension drawing
RMW-1	1544643	Spring arm for encoders; max. contact pressure 40 N; for encoders with measuring wheel	
RMW-2	1544644	Aluminium measuring wheel (cross-knurled) for encoders, perimeter 0.2 m, width 12 mm, depth 10 mm	
RMW-3	1544645	Hytrel measuring wheel (smooth) for encoders, perimeter 0.2 m, width 12 mm, temp.range -10...+50°C, depth 10 mm	
RMW-4	1544646	Hytrel measuring wheel (grooved) for encoders, perimeter 0.2 m, width 12 mm, temp.range -10...+70 °C, depth 10 mm	
RMW-5	1544647	Aluminium measuring wheel (cross-knurled) for encoders, perimeter 0.5 m, width 25 mm, depth 10 mm	

Rotative measurement
Absolute rotary encoder / Multiturn
RM-29S6S-9A28B-R3M12

Accessories

Type code	Ident no.	Description	Dimension drawing
RMW-6	1544648	Hytrel measuring wheel (smooth) for encoders, perimeter 0.5 m, width 25 mm, temp.range -10...+50°C, depth 10 mm	
RMW-7	1544649	Vulkollan measuring wheel (smooth) for encoders, perimeter 0.5 m, width 25 mm, temp.range -30...+80°C, depth 10 mm	
RMW-8	1544650	Aluminium measuring wheel with knobby rubber surface for encoders, perimeter 0.5 m, width 25 mm, temp.range -30...+80°C, depth 10 mm	
RMW-9	1544651	Hytrel measuring wheel (grooved) for encoders, perimeter 0.5 m, width 25 mm, temp.range -10...50 °C, depth 10 mm	