

Draw-Wire
DW6000-155-PA-H1141

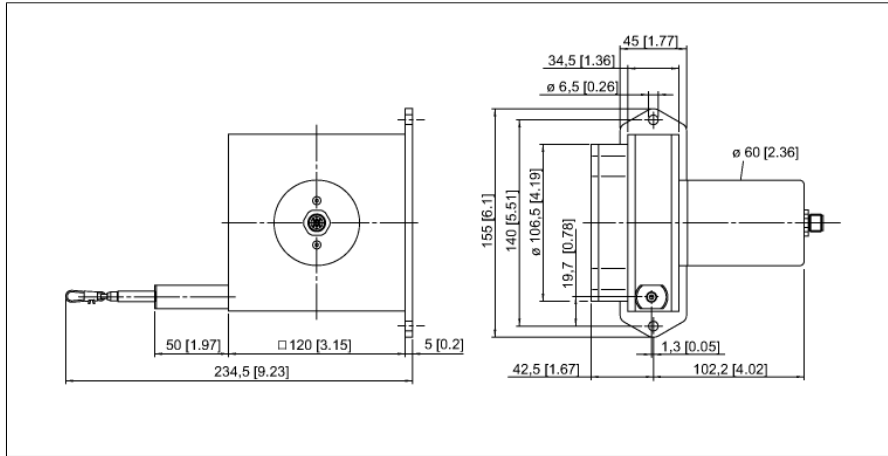

- Measuring range up to 6000mm
- M12 connector
- Protection class: IP65
- Potentiometric output 1k Ohm
- Supply voltage max. 30 VDC

1	U _B	+
2	out	
3	GND	
4	n.c.	

Type code	DW6000-155-PA-H1141
Ident no.	1544551
Measuring range [A...B]	6000mm
Linearity deviation	≤ 0.1 %
Ambient temperature	-20...+85 °C
Operating voltage	0...30VDC
Short-circuit protection	yes
Output function	3-wire, Potentiometer
Housing material	aluminium, titanium anodized
min. extension force	8.8 N
max. extension force	12.3 N
max. extension speed	10 m/s
max. extension speed	140 m/s ²
wire material	Stainless steel
Connection	male, M12 x 1
Protection class	IP65

Draw-Wire
DW6000-155-PA-H1141

TURCK

Industrial
Automation

Pin configuration

Signal	+U _s	Slider	Gnd	-	-	-	-	-	-
Pin configuration	1	2	3	4	-	-	-	-	-

Draw-Wire
DW6000-155-PA-H1141

TURCK

Industrial
Automation

Accessories

Type code	Ident no.	Description	Dimension drawing
RDR-1	1544753	Deflection roller for aluminium draw-wire sensors	