



Safety command devices
Emergency stop pushbuttons, ES21, Switching
element

ES21-CG1001



Model Name > [ES21-CG1001](#)
Part No. > [6036139](#)



At a glance

- Either as surface-mounted version with housing or as built-in version (Ø 22 mm)
- Built-in version for machine control panels with self-monitoring contacts between the pushbutton and switching element
- Surface-mounted version for direct mounting on different machines and systems
- Rotational or key unlocking
- Variants with LED ring lighting
- Available with protective collar to prevent inadvertent actuation

Your benefits

- Increased safety due to self-monitoring contacts
- Reduction in accidental faults due to variants with a protective collar
- User-friendly status indicator identified by a colored mark or LED ring around the pushbutton simplifies diagnostics
- Successful down to the last detail: award-winning and appealing design



Technical data

Type of command unit:	Emergency stop pushbutton
Mounting version:	Panel mount version
Protection class:	II (EN 50178)
Ambient operating temperature from ... to:	-30 °C ... 85 °C
B10d parameter:	4.75* 1E 06 switching cycles
Switching principle:	Slow action switching element
Number of positive action N/C contacts:	1
Number of N/O contacts:	0
Mechanical life (relay contacts):	1* 1E 06 switching cycles
Electrical life:	1* 1E 06 switching cycles ¹⁾
Usage category:	AC-15/DC-13 (EN 60947-5-1)
Rated operating current (voltage):	3 A (250 V AC) 2 A (24 V DC)
Rated current (voltage) according to EN 61058-1:	16 A (10 A) 250 V AC 10 A (6 A) 440 V AC
Contact module for panel mount version:	✓
Illumination connection:	-
Weight:	60 g

1) At rated load

Dimensional drawing

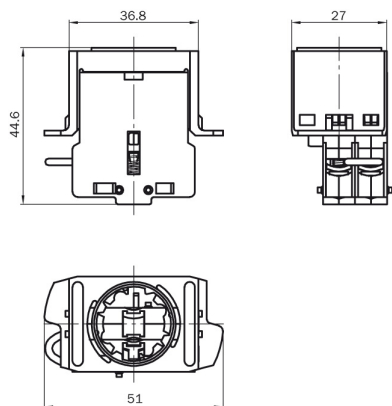

Australia

Phone +61 3 9457 0600
1800 334 802 – tollfree
E-Mail sales@sick.com.au

Belgium/Luxembourg

Phone +32 (0)2 466 55 66
E-Mail info@sick.be

Brasil

Phone +55 11 3215-4900
E-Mail sac@sick.com.br

Canada

Phone +1 905 771 14 44
E-Mail information@sick.com

Ceská Republika

Phone +420 2 57 91 18 50
E-Mail sick@sick.cz

China

Phone +86 4000 121 000
E-Mail info.china@sick.net.cn
Phone +852-2153 6300
E-Mail ghk@sick.com.hk

Danmark

Phone +45 45 82 64 00
E-Mail sick@sick.dk

Deutschland

Phone +49 211 5301-301
E-Mail kundenservice@sick.de

España

Phone +34 93 480 31 00
E-Mail info@sick.es

France

Phone +33 1 64 62 35 00
E-Mail info@sick.fr

Great Britain

Phone +44 (0)1727 831121
E-Mail info@sick.co.uk

India

Phone +91-22-4033 8333
E-Mail info@sick-india.com

Israel

Phone +972-4-6801000
E-Mail info@sick-sensors.com

Italia

Phone +39 02 27 43 41
E-Mail info@sick.it

Japan

Phone +81 (0)3 3358 1341
E-Mail support@sick.jp

Magyarország

Phone +36 1 371 2680
E-Mail office@sick.hu

Nederlands

Phone +31 (0)30 229 25 44
E-Mail info@sick.nl

Norge

Phone +47 67 81 50 00
E-Mail austefjord@sick.no

Österreich

Phone +43 (0)22 36 62 28 8-0
E-Mail office@sick.at

Polska

Phone +48 22 837 40 50
E-Mail info@sick.pl

România

Phone +40 356 171 120
E-Mail office@sick.ro

Russia

Phone +7-495-775-05-30
E-Mail info@sick.ru

Schweiz

Phone +41 41 619 29 39
E-Mail contact@sick.ch

Singapore

Phone +65 6744 3732
E-Mail admin@sicksgp.com.sg

Slovenija

Phone +386 (0)1-47 69 990
E-Mail office@sick.si

South Africa

Phone +27 11 472 3733
E-Mail info@sickautomation.co.za

South Korea

Phone +82 2 786 6321/4
E-Mail info@sickkorea.net

Suomi

Phone +358-9-25 15 800
E-Mail sick@sick.fi

Sverige

Phone +46 10 110 10 00
E-Mail info@sick.se

Taiwan

Phone +886-2-2375-6288
E-Mail sales@sick.com.tw

Türkiye

Phone +90 (216) 528 50 00
E-Mail info@sick.com.tr

United Arab Emirates

Phone +971 (0) 4 8865 878
E-Mail info@sick.ae

USA/México

Phone +1(952) 941-6780
1 800-325-7425 – tollfree
E-Mail info@sickusa.com

More representatives and agencies
at www.sick.com