



Long range distance sensors  
Dx100, DL100, CANopen

DL100-11AA2109



**Model Name** > [DL100-11AA2109](#)  
**Part No.** > [1060392](#)



**At a glance**

- Measuring range up to 220 m
- Numerous fieldbus interfaces
- Pre-failure notification and diagnostic data available
- Display with intuitive menu structure and clearly visible status LEDs
- Small, rugged metal housing
- 3-axis alignment bracket with quick-lock system as accessory available
- Elongated holes for zero point adjustment when replacing devices

**Your benefits**

- 100,000 hours of laser service life ensures that the sensor will have a long, useful life with maximum reliability
- Versions with integrated heating enable reliable use at ambient temperatures at up to -40°C. The TPCC cooling housing, available as an option, enables use at up to +75°C
- The numerous interfaces offer a high degree of flexibility as well as rapid communication for maximum productivity
- Pre-failure notification and diagnostic data for maximum plant availability
- Small, rugged metal housing with SpeedCon™ compatible connectors ensures smooth handling - even in confined spaces
- Alignment bracket with quick lock system ensures fast alignment and easy device replacement, reducing maintenance and mounting costs

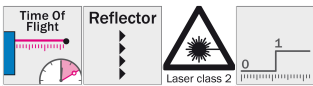

**Performance**

Measuring range:	0.15 m ... 60 m, On reflective tape "Diamond Grade"
Resolution:	0.1 mm, 0.125 mm, 1 mm, 10 mm, 100 mm
Repeatability <sup>1)</sup> :	1.5 mm (at dead time 10 ms), 0.75 mm (at dead time 30 ms)
Accuracy <sup>2)</sup> :	± 3 mm
Light source <sup>3)</sup> :	Laser, red
Typ. light spot size (distance):	5 mm (+ 2 mm x distance in m)
Internal measurement cycle:	1 ms
Max. movement speed:	10 m/s
Laser class:	2 (EN 60825-1/CDRH)

<sup>1)</sup> Statistical error 1 σ, environmental conditions constant, depending on operating mode <sup>2)</sup> From 150 mm ... 180 mm measuring range the accuracy can reach ± 4 mm

<sup>3)</sup> Average service life of 100,000 h at T<sub>A</sub> = +25 °C

## Interfaces

---

Data interface:	CANopen
Output type <sup>1)</sup> :	B (push/pull) MF1, MF2
Multifunctional input (MF) <sup>2)</sup> :	1 x MF1

<sup>1)</sup> HIGH > V<sub>S</sub> - 3 V / LOW < 2 V    <sup>2)</sup> HIGH > 12 V / LOW < 3 V

## Mechanics/electronics

---

Supply voltage V <sub>s</sub> :	DC 18 V ... 30 V, limit values
Ripple <sup>1)</sup> :	5 Vpp
Initialization time <sup>2)</sup> :	Typ. 1.5 s
Indication:	6 digit 5 x 7 dot matrix display, LEDs
Weight <sup>3)</sup> :	Ca. 800 g ... 1,600 g
Output current I <sub>A</sub> <sup>4)</sup> :	≤ 100 mA
Power consumption:	At 24 V DC < 250 mA
Connection type:	Connector M12, SPEEDCON™ compatible
Housing material:	Aluminum/zinc die-cast

<sup>1)</sup> May not fall short of or exceed V<sub>S</sub> tolerances    <sup>2)</sup> After loss of reflector < 40 ms    <sup>3)</sup> Without mounting bracket: approx. 800 g, with mounting bracket: approx. 1,600 g

<sup>4)</sup> Short circuit/overload protected. Max. 100 nF/20 mH

## Ambient data

---

Enclosure rating:	IP 65
Protection class:	III
Effect of air pressure:	0.3 ppm/hPa
Effect of air temperature:	1 ppm/K
Temperature drift:	Typ. 0.1 mm/K
Ambient temperature <sup>1)</sup> :	Operation: -20 ... 55 °C Operation with cooling case: -20 ... 75 °C Storage: -40 ... 75 °C
Mechanical load:	Noise: EN 600 68-2-64 Shock: EN 600 68-2-27 Sine: EN 600 68-2-6
Electromagnetic compatibility (EMC) <sup>2)</sup> :	EN 61000-6-2/EN 61000-6-4

<sup>1)</sup> Temperatures < -10 °C require warm-up time of typ. 7 minutes.    <sup>2)</sup> This is a Class A device. This device can cause radio interference in living quarters.

## Dimensional drawing

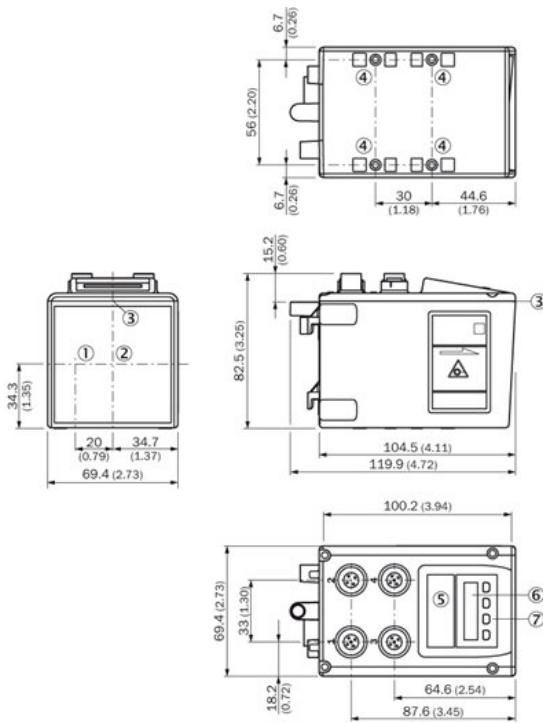

- |1| Optical axis, sender
- |2| Optical axis, receiver
- |3| Zero level
- |4| Threaded mounting hole M5
- |5| Status LED [status]
- |6| Display
- |7| Control elements

## Adjustment possible

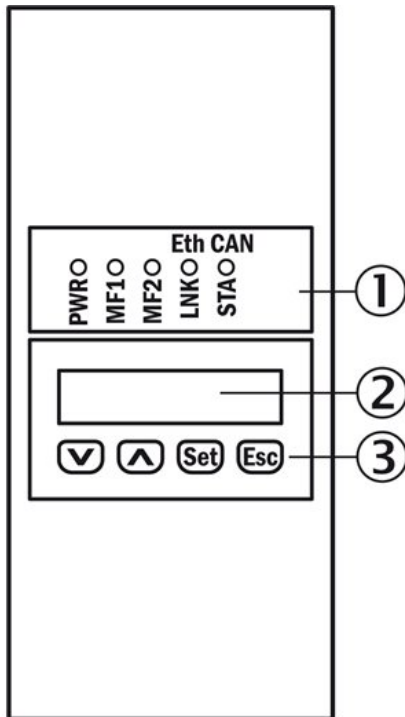

- |1| Status LED [status]
- |2| Display
- |3| Control elements

Connection type power supply

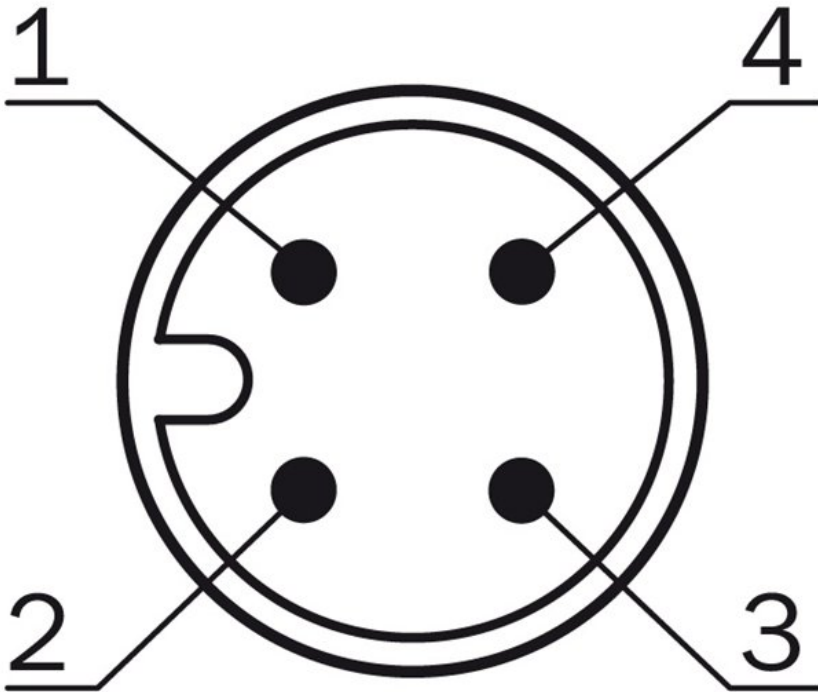

Connection diagram power supply

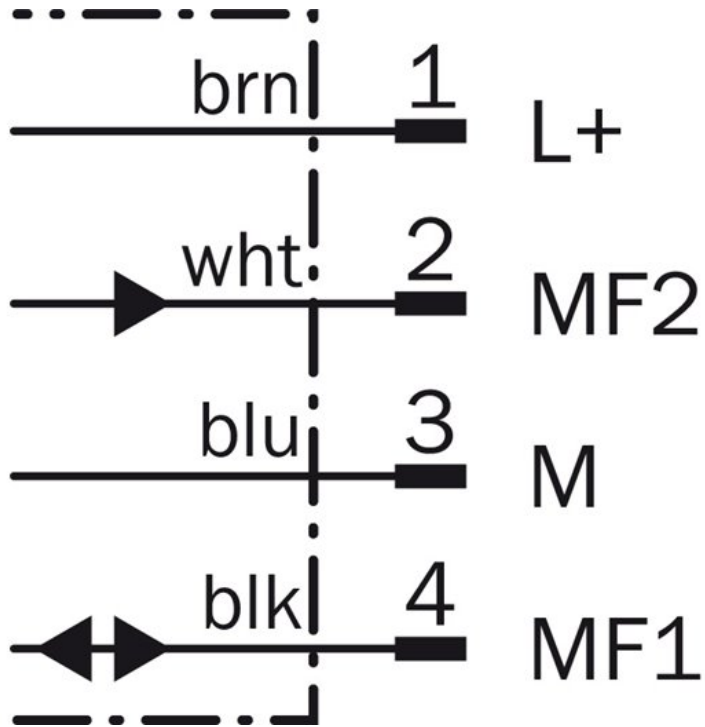

Connection diagram Ethernet

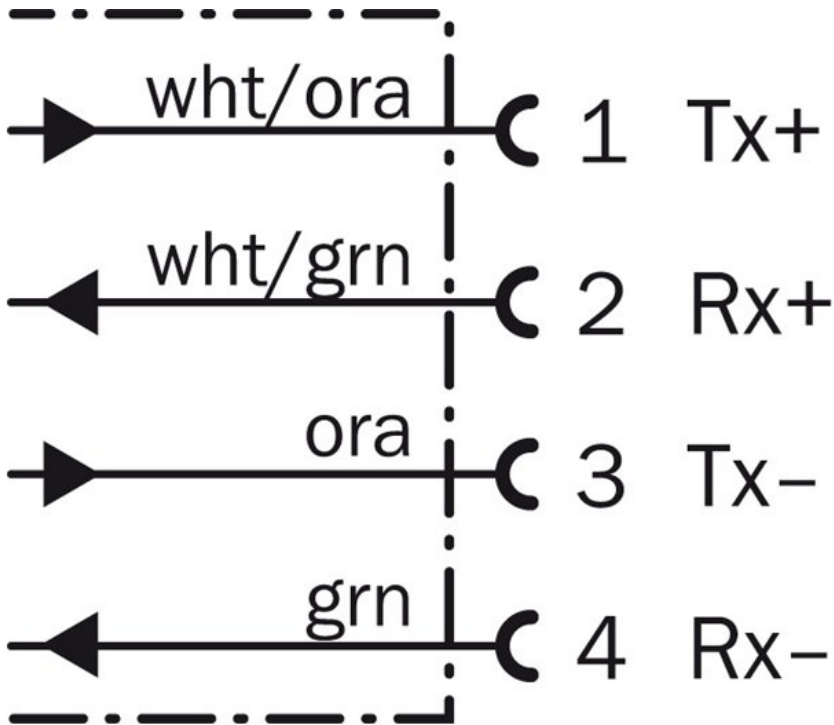

Connection type CANin

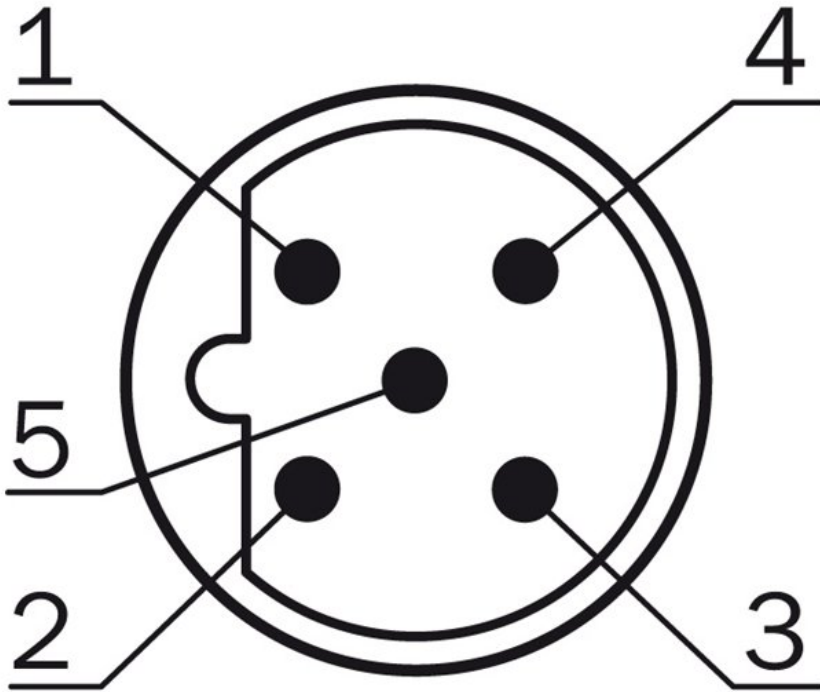

Connection diagramm CANin

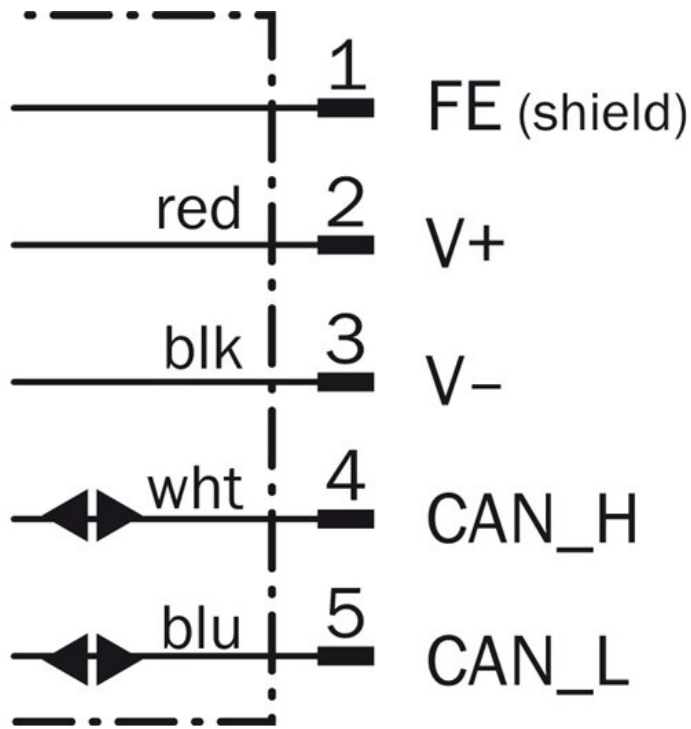

Connection type CANout

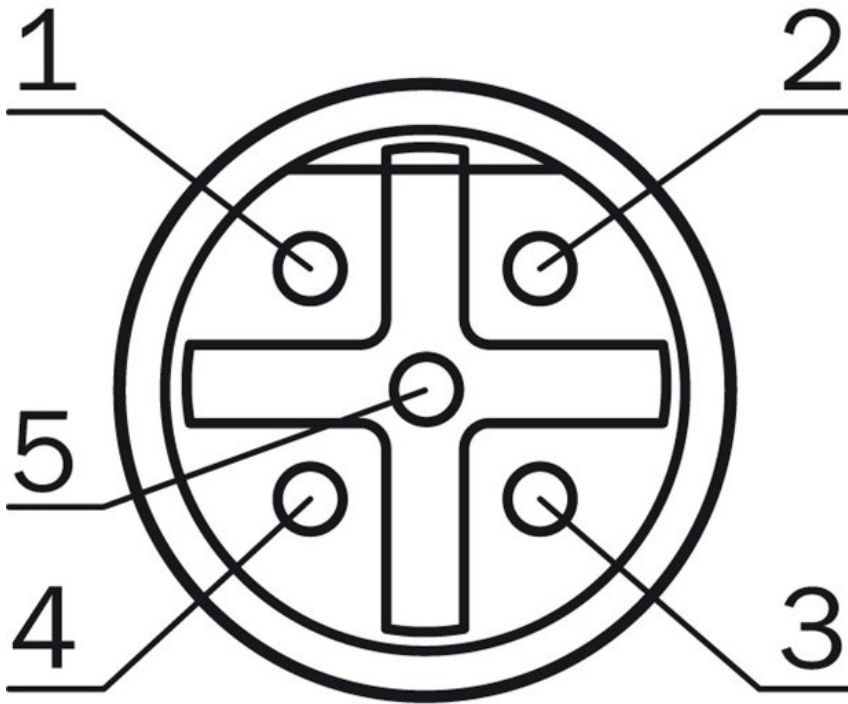

Connection diagramm CANout

---

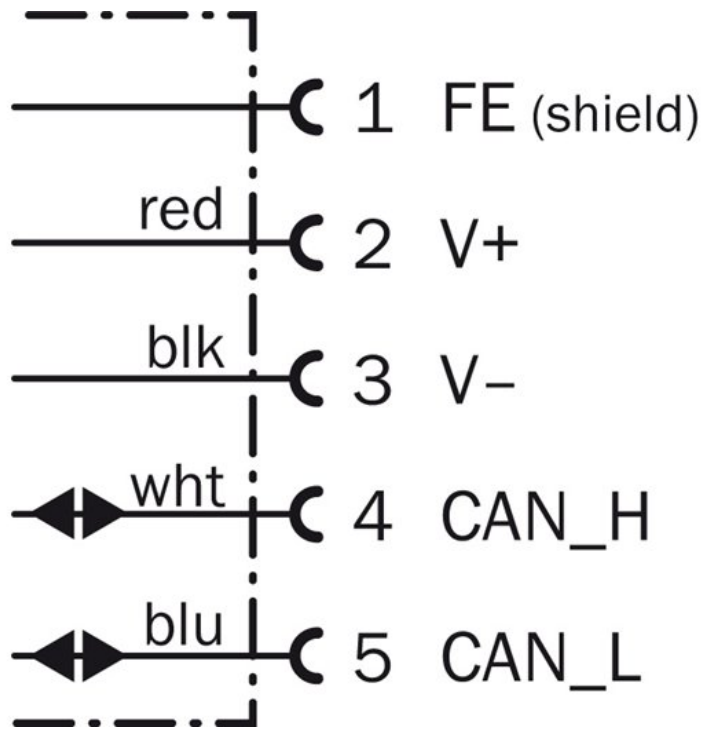



**Australia**

Phone +61 3 9457 0600  
1800 334 802 – tollfree  
E-Mail sales@sick.com.au

**Belgium/Luxembourg**

Phone +32 (0)2 466 55 66  
E-Mail info@sick.be

**Brasil**

Phone +55 11 3215-4900  
E-Mail sac@sick.com.br

**Canada**

Phone +1 905 771 14 44  
E-Mail information@sick.com

**Ceská Republika**

Phone +420 2 57 91 18 50  
E-Mail sick@sick.cz

**China**

Phone +86 4000 121 000  
E-Mail info.china@sick.net.cn  
Phone +852-2153 6300  
E-Mail ghk@sick.com.hk

**Danmark**

Phone +45 45 82 64 00  
E-Mail sick@sick.dk

**Deutschland**

Phone +49 211 5301-301  
E-Mail kundenservice@sick.de

**España**

Phone +34 93 480 31 00  
E-Mail info@sick.es

**France**

Phone +33 1 64 62 35 00  
E-Mail info@sick.fr

**Great Britain**

Phone +44 (0)1727 831121  
E-Mail info@sick.co.uk

**India**

Phone +91-22-4033 8333  
E-Mail info@sick-india.com

**Israel**

Phone +972-4-6801000  
E-Mail info@sick-sensors.com

**Italia**

Phone +39 02 27 43 41  
E-Mail info@sick.it

**Japan**

Phone +81 (0)3 3358 1341  
E-Mail support@sick.jp

**Magyarország**

Phone +36 1 371 2680  
E-Mail office@sick.hu

**Nederlands**

Phone +31 (0)30 229 25 44  
E-Mail info@sick.nl

**Norge**

Phone +47 67 81 50 00  
E-Mail austefjord@sick.no

**Österreich**

Phone +43 (0)22 36 62 28 8-0  
E-Mail office@sick.at

**Polska**

Phone +48 22 837 40 50  
E-Mail info@sick.pl

**România**

Phone +40 356 171 120  
E-Mail office@sick.ro

**Russia**

Phone +7-495-775-05-30  
E-Mail info@sick.ru

**Schweiz**

Phone +41 41 619 29 39  
E-Mail contact@sick.ch

**Singapore**

Phone +65 6744 3732  
E-Mail admin@sicksgp.com.sg

**Slovenija**

Phone +386 (0)1-47 69 990  
E-Mail office@sick.si

**South Africa**

Phone +27 11 472 3733  
E-Mail info@sickautomation.co.za

**South Korea**

Phone +82 2 786 6321/4  
E-Mail info@sickkorea.net

**Suomi**

Phone +358-9-25 15 800  
E-Mail sick@sick.fi

**Sverige**

Phone +46 10 110 10 00  
E-Mail info@sick.se

**Taiwan**

Phone +886-2-2375-6288  
E-Mail sales@sick.com.tw

**Türkiye**

Phone +90 (216) 528 50 00  
E-Mail info@sick.com.tr

**United Arab Emirates**

Phone +971 (0) 4 8865 878  
E-Mail info@sick.ae

**USA/México**

Phone +1(952) 941-6780  
1 800-325-7425 – tollfree  
E-Mail info@sickusa.com

More representatives and agencies  
at [www.sick.com](http://www.sick.com)