



Mid range distance sensors Dx60, DL60

DL60-P111B0015



Model Name > [DL60-P111B0015](#)
Part No. > [1043406](#)



At a glance

- Measuring range: 24 m on reflector
- Analog output: 4 mA ... 20 mA
- Teach-in and plug and play versions
- Time-of-flight technology for reliable results
- Visible red laser light
- Power-on LED

Your benefits

- Measuring range up to 24 m and both analog as well as switching outputs ensure high application flexibility
- Red laser light ensures fast and precise alignment
- Tough, lightweight housing withstands harsh environments
- Easy one-button teach-in offers fast commissioning
- High switching and measuring accuracy increase process reliability, ensuring higher productivity and better quality
- Pre-set plug and play versions ensure immediate commissioning, eliminating any kind of sensor teach-in



Performance

Measuring range ¹⁾ :	300 mm ... 15,000 mm
Resolution:	(7 mm)
Accuracy ²⁾ :	± 15 mm
Response time:	130 ms
Cycle time:	8
Output rate:	< 8 ms
Light source:	Laser, red
Laser protection class:	2 (EN 60825-1)
Typ. light spot size (distance):	20 mm x 20 mm (at 2 m)
Additional function:	Inverted switching output
Service life:	50,000 h

¹⁾ On reflector REF-3930-K2 ²⁾

Interfaces

Analog output:	4 mA ... 20 mA
Resolution analog output:	12 bit
Multifunctional input:	1x Laser off
Switching output (max. output current):	1 x PNP (100 mA)

Output Q short-circuit protected; PNP: HIGH = Vs - (< 2 V), LOW = 0;

Mechanics/electronics

Supply voltage Vs ¹⁾ :	DC 11 V ... 30 V
Ripple ²⁾ :	≤ 5 Vpp
Power consumption ³⁾ :	≤ 3 W
Initialization time:	550 ms
Warm-up time:	≤ 30 min
Connection type:	Connector M12, 5-pin
Indication:	Status LED
Weight:	202 g

¹⁾ Limit values, reverse-polarity protected, operation in short-circuit protected network, max. 8 A ²⁾ May not fall short of or exceed V_S tolerances ³⁾ Without load

Ambient data

Enclosure rating:	IP 67
Protection class:	II
EMC:	EN 61000-6-2 EN 60947-5-2
Ambient temperature:	Operation: -25 ... 55 °C Storage: -25 ... 75 °C

Dimensional drawing

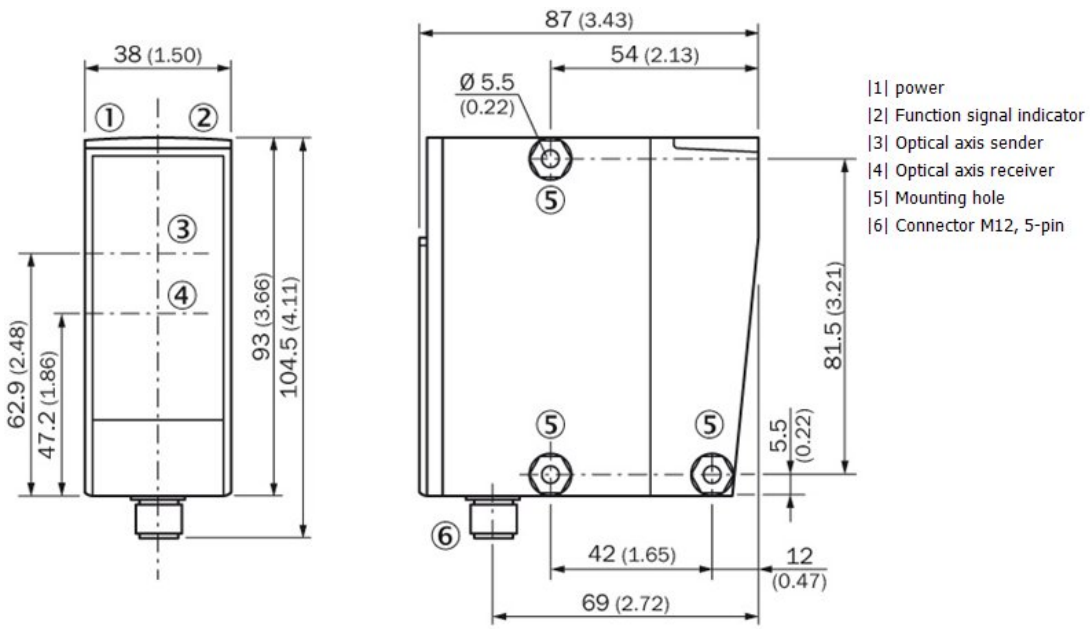

All dimensions in mm (inch)

Adjustment possible

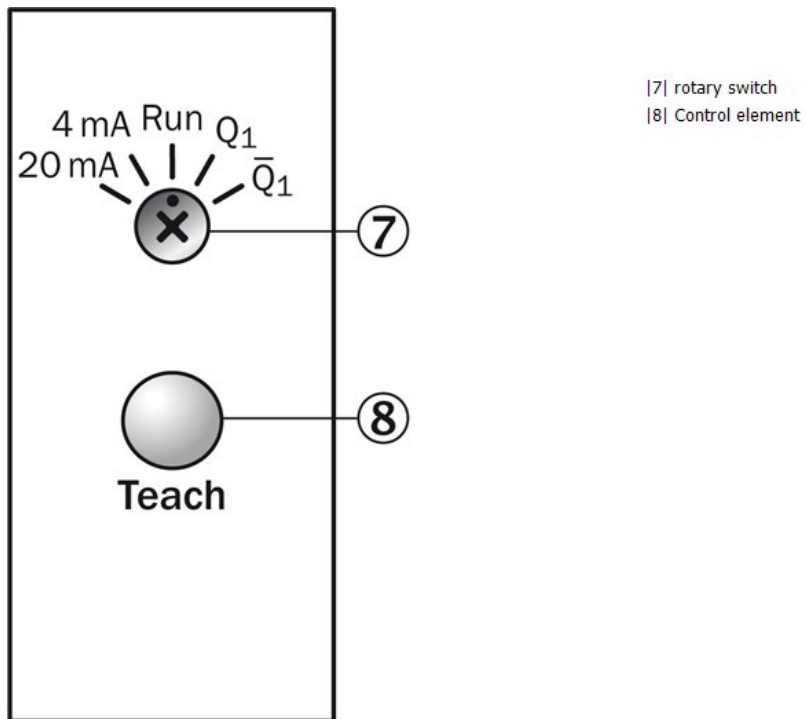

Connection type

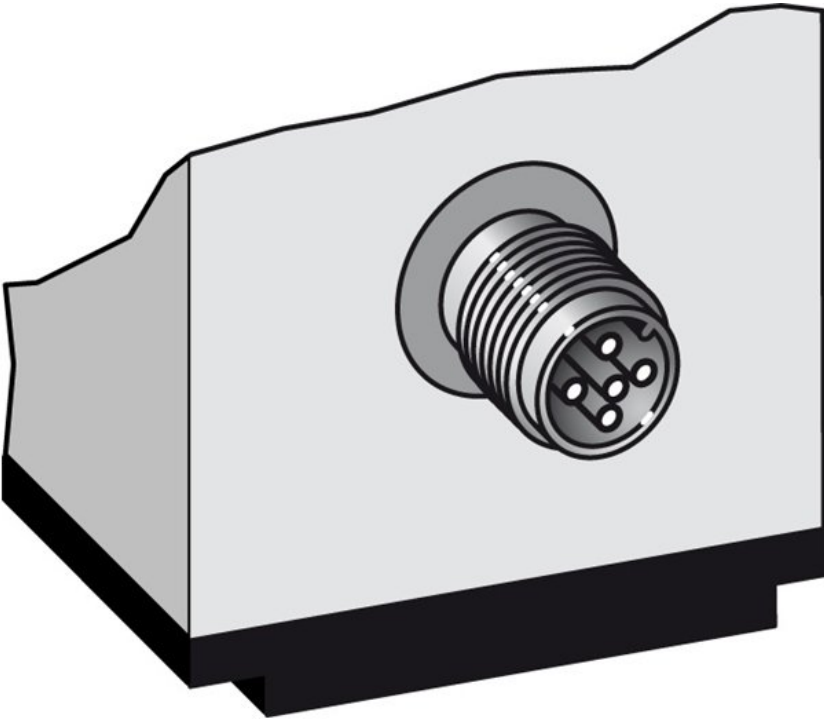

Connection diagram

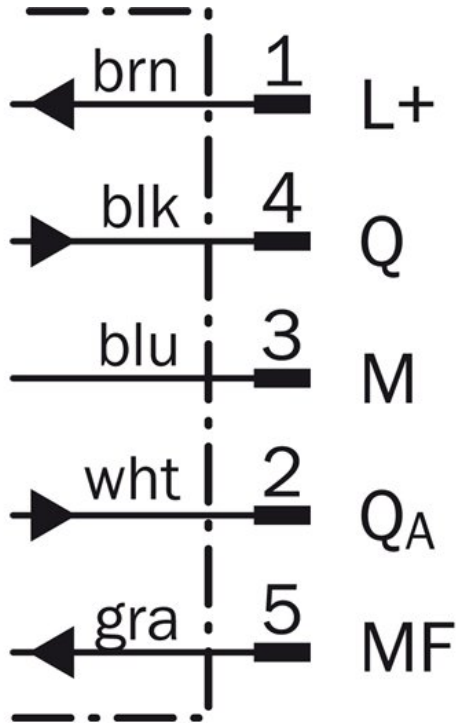

Plug & Play: How to choose different measurement ranges by the type code (4 mA ... 20 mA)

The DL60 can be factory scaled for customer specific measurement ranges based on the type code.

The type code is: "DL60-x11xBbbee". The „bbee“-part defines the measurement range as follows:

bb (begin) $\hat{=}$ distance value chosen by the customer to be output with 4 mA. The "bb"-value is defined in m.

ee (end) $\hat{=}$ distance value chosen by the customer to be output with 20 mA. The "ee"-value is defined in m.

Be aware

ee/bb $\hat{=}$ 00 $\hat{=}$ 300 mm (smallest possible distance value).

There is a minimum difference between "bb" and "ee" of at least 1 unit (1,000 mm) (e.g. bb $\hat{=}$ 02 \rightarrow ee $\hat{\geq}$ 03)

Range of values

00 ... 24 $\hat{=}$ 300 mm ... 24,000 mm, any configuration within this range can be chosen (e.g. 0010, 0224 etc.).

Examples

Model name	Description
DL60-P111B0010	DL60, switching output PNP, measurement range 300 mm ... 10,000 mm (4 mA $\hat{=}$ 0.3 m ... 20 mA $\hat{=}$ 10 m)
DL60-N111B0915	DL60, switching output NPN, measurement range 9,000 mm ... 15,000 mm (4 mA $\hat{=}$ 9 m ... 20 mA $\hat{=}$ 15 m)
DL60-P111B2402	DL60, switching output PNP, measurement range 24,000 mm ... 2,000 mm (inverted measuring area) (4 mA $\hat{=}$ 24 m ... 20 mA $\hat{=}$ 2 m)

ee > bb

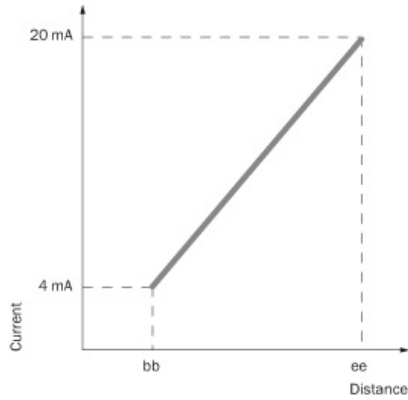

bb > ee (inverted measuring area)

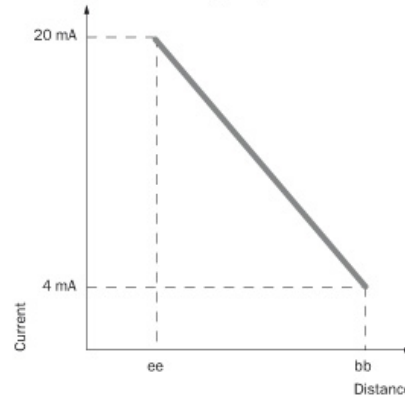

Australia

Phone +61 3 9457 0600
1800 334 802 – tollfree
E-Mail sales@sick.com.au

Belgium/Luxembourg

Phone +32 (0)2 466 55 66
E-Mail info@sick.be

Brasil

Phone +55 11 3215-4900
E-Mail sac@sick.com.br

Canada

Phone +1 905 771 14 44
E-Mail information@sick.com

Ceská Republika

Phone +420 2 57 91 18 50
E-Mail sick@sick.cz

China

Phone +86 4000 121 000
E-Mail info.china@sick.net.cn
Phone +852-2153 6300
E-Mail ghk@sick.com.hk

Danmark

Phone +45 45 82 64 00
E-Mail sick@sick.dk

Deutschland

Phone +49 211 5301-301
E-Mail kundenservice@sick.de

España

Phone +34 93 480 31 00
E-Mail info@sick.es

France

Phone +33 1 64 62 35 00
E-Mail info@sick.fr

Great Britain

Phone +44 (0)1727 831121
E-Mail info@sick.co.uk

India

Phone +91-22-4033 8333
E-Mail info@sick-india.com

Israel

Phone +972-4-6801000
E-Mail info@sick-sensors.com

Italia

Phone +39 02 27 43 41
E-Mail info@sick.it

Japan

Phone +81 (0)3 3358 1341
E-Mail support@sick.jp

Magyarország

Phone +36 1 371 2680
E-Mail office@sick.hu

Nederlands

Phone +31 (0)30 229 25 44
E-Mail info@sick.nl

Norge

Phone +47 67 81 50 00
E-Mail austefjord@sick.no

Österreich

Phone +43 (0)22 36 62 28 8-0
E-Mail office@sick.at

Polska

Phone +48 22 837 40 50
E-Mail info@sick.pl

România

Phone +40 356 171 120
E-Mail office@sick.ro

Russia

Phone +7-495-775-05-30
E-Mail info@sick.ru

Schweiz

Phone +41 41 619 29 39
E-Mail contact@sick.ch

Singapore

Phone +65 6744 3732
E-Mail admin@sicksgp.com.sg

Slovenija

Phone +386 (0)1-47 69 990
E-Mail office@sick.si

South Africa

Phone +27 11 472 3733
E-Mail info@sickautomation.co.za

South Korea

Phone +82 2 786 6321/4
E-Mail info@sickkorea.net

Suomi

Phone +358-9-25 15 800
E-Mail sick@sick.fi

Sverige

Phone +46 10 110 10 00
E-Mail info@sick.se

Taiwan

Phone +886-2-2375-6288
E-Mail sales@sick.com.tw

Türkiye

Phone +90 (216) 528 50 00
E-Mail info@sick.com.tr

United Arab Emirates

Phone +971 (0) 4 8865 878
E-Mail info@sick.ae

USA/México

Phone +1(952) 941-6780
1 800-325-7425 – tollfree
E-Mail info@sickusa.com

More representatives and agencies
at www.sick.com