



Mid range distance sensors Dx60, DS60

DS60-N31111



Model Name > **DS60-N31111**
Part No. > **1016494**



At a glance

- Measuring range up to 6 m on target and 20 m on reflector
- Safe background suppression of any object in the back (up to 100 m)
- Two invertible switching outputs
- Time-of-flight technology for reliable results
- Precise alignment with red laser light
- Teach-in

Your benefits

- Durable, lightweight housing withstands harsh environments
- Easy one-button teach-in offers fast commissioning
- High switching accuracy increases process reliability, ensuring higher productivity and better quality
- Different measurement options (on object, on reflector or foreground suppression) ensure flexible use and highest reliability within the application
- Both red and infrared laser models enable users to choose the best light source for their application - visible or invisible
- The two switching outputs of the DS60 reduce investment and commissioning costs



Performance

Measuring range	1), 2), 3):	80 mm ... 6,000 mm, 90 % remission 80 mm ... 4,600 mm, 18 % remission 80 mm ... 2,400 mm, 6 % remission
Response time:		10 ms
Switching frequency:		50 Hz
Light source:		Laser, infrared
Laser protection class:		1 (EN 60825-1)
Typ. light spot size (distance):		60 mm x 60 mm (at 6 m)
Additional function:		Inverted switching output ObSB mode
Service life:		50,000 h

1) 2) 3) Teach-in from 200 ... 6,000 mm

Interfaces

Switching output (max. output current): 2x NPN (100 mA)

Output Q short-circuit protected; NPN: HIGH = < 2.5 V / LOW = V_S ;

Mechanics/electronics

Supply voltage V_S ¹⁾: DC 18 V ... 30 V
Ripple²⁾: ≤ 5 Vpp
Power consumption³⁾: ≤ 3 W
Connection type: Connector M12, 5-pin
Weight: 202 g

¹⁾ Limit values, reverse-polarity protected, operation in short-circuit protected network, max. 8 A ²⁾ May not fall short of or exceed V_S tolerances ³⁾ Without load

Ambient data

Enclosure rating: IP 67
Protection class: II
EMC: EN 61000-6-2
EN 60947-5-2
Ambient temperature: Operation: -25 ... 55 °C
Storage: -25 ... 75 °C

Dimensional drawing

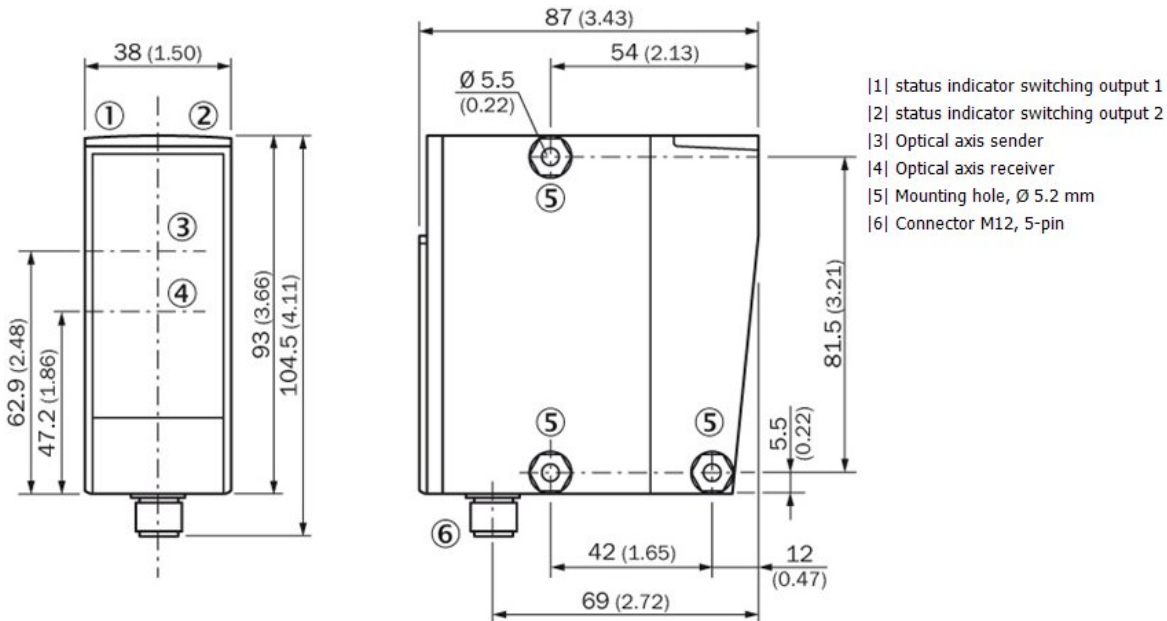

All dimensions in mm (inch)

Adjustment possible

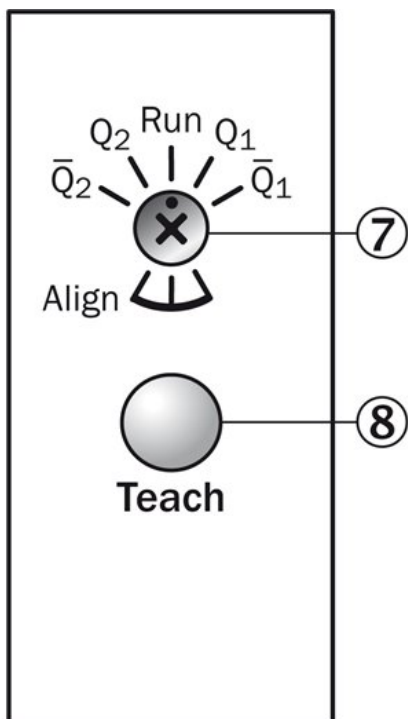

|7| rotary switch
|8| Control element

Connection type

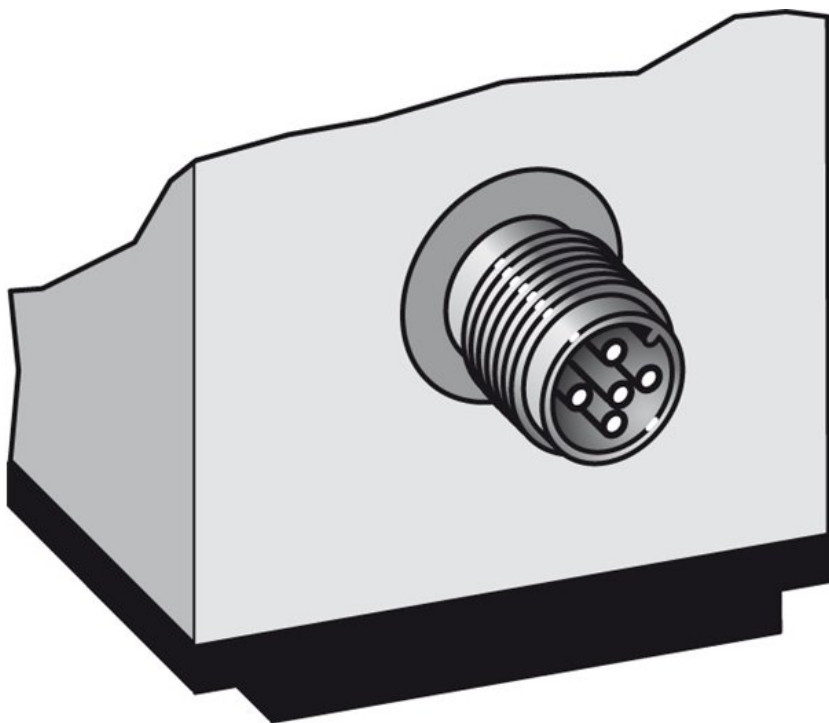

Connection diagram

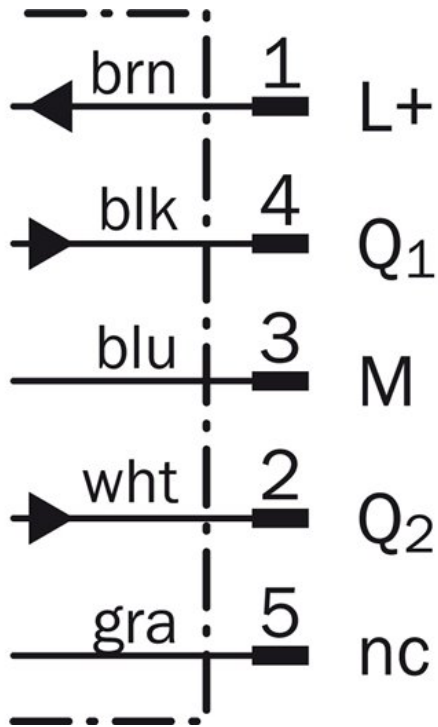

Sensing distance

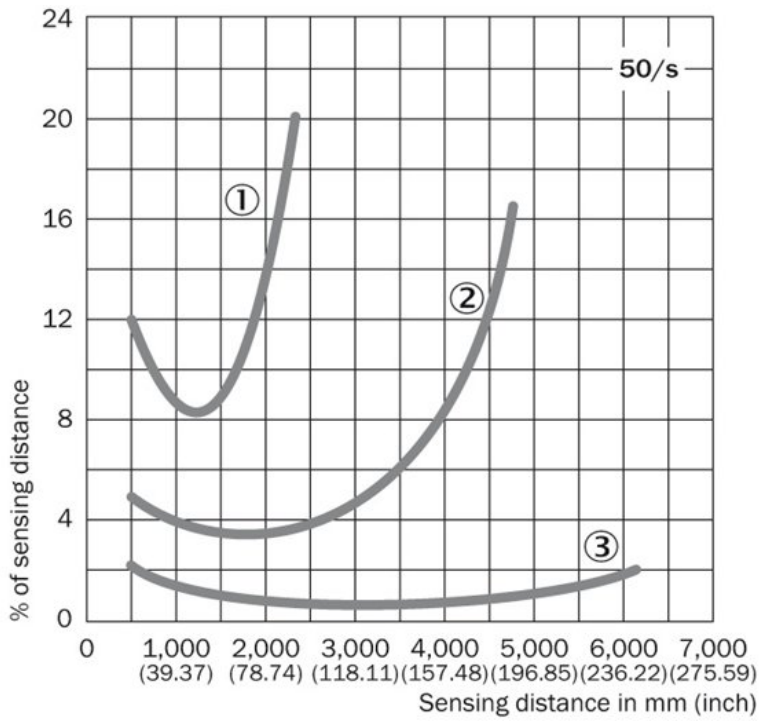

- |1| 6 % / 90 %
- |2| 18 % / 90 %
- |3| 90 % / 90 %

Australia

Phone +61 3 9457 0600
1800 334 802 – tollfree
E-Mail sales@sick.com.au

Belgium/Luxembourg

Phone +32 (0)2 466 55 66
E-Mail info@sick.be

Brasil

Phone +55 11 3215-4900
E-Mail sac@sick.com.br

Canada

Phone +1 905 771 14 44
E-Mail information@sick.com

Ceská Republika

Phone +420 2 57 91 18 50
E-Mail sick@sick.cz

China

Phone +86 4000 121 000
E-Mail info.china@sick.net.cn
Phone +852-2153 6300
E-Mail ghk@sick.com.hk

Danmark

Phone +45 45 82 64 00
E-Mail sick@sick.dk

Deutschland

Phone +49 211 5301-301
E-Mail kundenservice@sick.de

España

Phone +34 93 480 31 00
E-Mail info@sick.es

France

Phone +33 1 64 62 35 00
E-Mail info@sick.fr

Great Britain

Phone +44 (0)1727 831121
E-Mail info@sick.co.uk

India

Phone +91-22-4033 8333
E-Mail info@sick-india.com

Israel

Phone +972-4-6801000
E-Mail info@sick-sensors.com

Italia

Phone +39 02 27 43 41
E-Mail info@sick.it

Japan

Phone +81 (0)3 3358 1341
E-Mail support@sick.jp

Magyarország

Phone +36 1 371 2680
E-Mail office@sick.hu

Nederlands

Phone +31 (0)30 229 25 44
E-Mail info@sick.nl

Norge

Phone +47 67 81 50 00
E-Mail austefjord@sick.no

Österreich

Phone +43 (0)22 36 62 28 8-0
E-Mail office@sick.at

Polska

Phone +48 22 837 40 50
E-Mail info@sick.pl

România

Phone +40 356 171 120
E-Mail office@sick.ro

Russia

Phone +7-495-775-05-30
E-Mail info@sick.ru

Schweiz

Phone +41 41 619 29 39
E-Mail contact@sick.ch

Singapore

Phone +65 6744 3732
E-Mail admin@sicksgp.com.sg

Slovenija

Phone +386 (0)1-47 69 990
E-Mail office@sick.si

South Africa

Phone +27 11 472 3733
E-Mail info@sickautomation.co.za

South Korea

Phone +82 2 786 6321/4
E-Mail info@sickkorea.net

Suomi

Phone +358-9-25 15 800
E-Mail sick@sick.fi

Sverige

Phone +46 10 110 10 00
E-Mail info@sick.se

Taiwan

Phone +886-2-2375-6288
E-Mail sales@sick.com.tw

Türkiye

Phone +90 (216) 528 50 00
E-Mail info@sick.com.tr

United Arab Emirates

Phone +971 (0) 4 8865 878
E-Mail info@sick.ae

USA/México

Phone +1(952) 941-6780
1 800-325-7425 – tollfree
E-Mail info@sickusa.com

More representatives and agencies
at www.sick.com