



## Fork sensors WFL

WFL80-95B416



**Model Name** > [WFL80-95B416](#)  
**Part No.** > [6036840](#)



*Illustration may differ*

**At a glance**

- Very precise laser beam (Class 1 laser)
- Simple and accurate adjustment via teach-in
- Fast response time (max. 100 µs)
- Minimum detectable object size of 0.05 mm
- PNP and NPN switching output
- Light/dark switching function
- 21 different models with different fork widths and depths
- Rugged, IP 65 aluminum housing

**Your benefits**

- A highly precise laser beam ensures consistent measurement accuracy along the entire measuring range and reliable detection of the smallest objects
- A visible laser light spot enables easy alignment and fast adjustment
- Reliable and simple setting via teach-in ensures high process reliability
- A wide range of different fork sizes increases installation flexibility
- The aluminum housing meets all requirements for use in harsh industrial conditions



**Features**

Functional principle:	Optical detection principle
Fork width:	80 mm
Fork depth:	95 mm
MDO <sup>1)</sup> :	0.05 mm
Label detection:	-
Light source:	Laser, Class 1, 670 nm
Adjustment:	Teach-in
Output function:	Light/darkswitching, selectable via button

<sup>1)</sup> Minimum detectable object

**Mechanics/electronics**

Supply voltage $V_s$ <sup>1)</sup> :	DC 10 V ... 30 V
Ripple <sup>2)</sup> :	< 10 %
Power consumption <sup>3)</sup> :	40 mA
Switching frequency <sup>4)</sup> :	10 kHz
Response time <sup>5)</sup> :	100 µs

Stability of response time:	± 20 µs
Output type:	NPN: HIGH = approx. VS / LOW ≤ 2 V PNP: HIGH = VS- ≤ 2 V / LOW approx. 0 V
Switching mode:	PNP/NPN
Output current I <sub>max.</sub> :	100 mA
Initialization time:	100 ms
Connection type:	Connector M8, 4-pin
Ambient light safety:	Sunlight: ≤ 10,000 klx
Protection class <sup>6)</sup> :	III
Circuit protection:	VS connections reverse-polarity protected Output Q short-circuit protected Interference suppression
Enclosure rating:	IP 65
Weight:	Ca. 36 g ... 160 g <sup>7)</sup>
Housing material:	Aluminum

<sup>1)</sup> Limit values, reverse-polarity protected, operation in short-circuit protected network, max. 8 A <sup>2)</sup> May not exceed or fall short of V<sub>S</sub> tolerances <sup>3)</sup> Without load <sup>4)</sup>  
 With light/dark ratio 1:1 <sup>5)</sup> Signal transit time with resistive load <sup>6)</sup> Reference voltage DC 50 V <sup>7)</sup> Depending on fork width

### Ambient data

Ambient temperature <sup>1)</sup> :	Operation: -20 ... 50 °C Storage: -30 ... 80 °C
Shock load:	According to EN 60068-2-27
UL File-No.:	UL No. NRKH.E191603 & cUL No. NRKH7.E191603, CDRH-conform

<sup>1)</sup> Do not bend below 0 °C

## Dimensional drawing

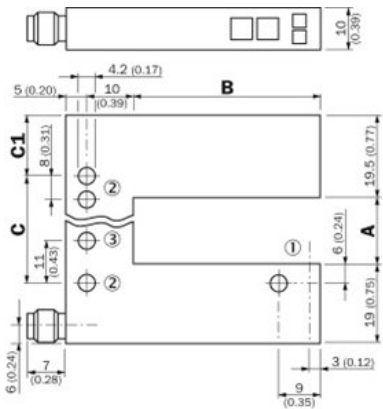

All dimensions in mm (inch)

### Dimensions in mm (inch)

	A Fork width	B Fork depth	C	C1
WFL2	2 (0.08)	42/59/95 (1.65/2.32/3.74)	14 (0.55)	13.5 (0.53)
WFL5	5 (0.20)	42/59/95 (1.65/2.32/3.74)	14 (0.55)	15 (0.59)
WFL15	15 (0.59)	42/59/95 (1.65/2.32/3.74)	27 (1.06)	13.5 (0.53)
WFL30	30 (1.18)	42/59/95 (1.65/2.32/3.74)	42 (1.65)	13.5 (0.53)
WFL50	50 (1.97)	42/59/95 (1.65/2.32/3.74)	51 (2.01)	24.5 (0.96)
WFL80	80 (3.15)	42/59/95 (1.65/2.32/3.74)	81 (3.19)	24.5 (0.96)
WFL120	120 (4.72)	42/59/95 (1.65/2.32/3.74)	121 (4.76)	24.5 (0.96)

- |1| Optical axis
- |2| Mounting hole,  $\varnothing$  4.2 mm
- |3| WFL50/80/120 only

## Adjustments

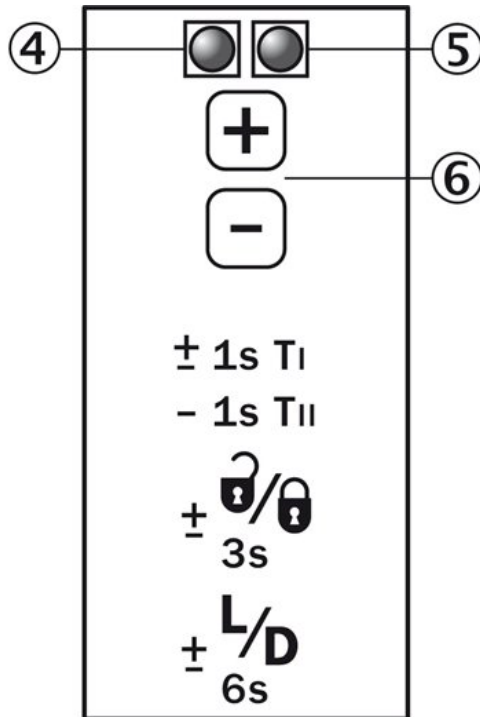

- |4| Function signal indicator (yellow), switching output
- |5| Function indicator (red)
- |6| "+" "-" buttons and function button

Connection type

---

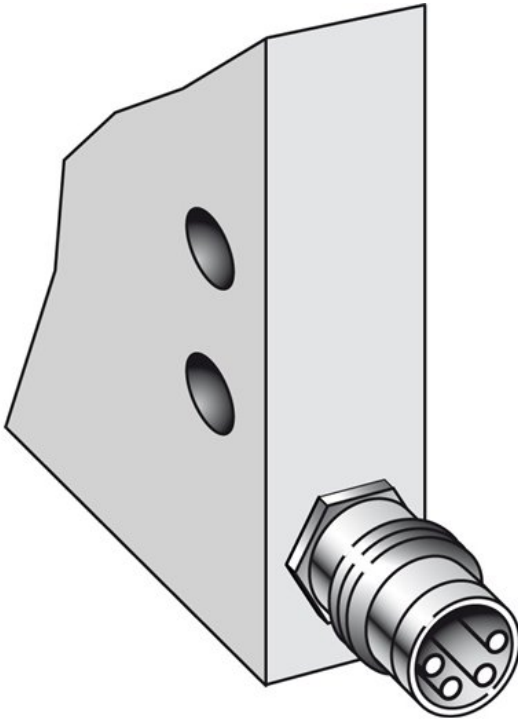

Connection diagram

---

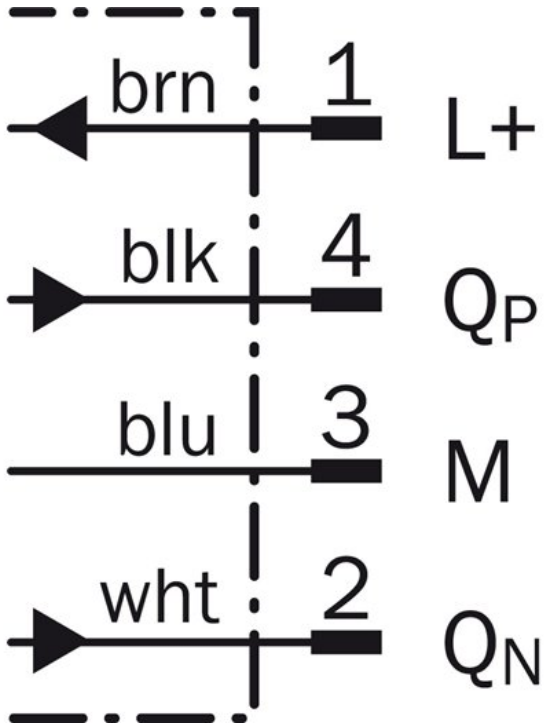

**Australia**

Phone +61 3 9457 0600  
1800 334 802 – tollfree  
E-Mail sales@sick.com.au

**Belgium/Luxembourg**

Phone +32 (0)2 466 55 66  
E-Mail info@sick.be

**Brasil**

Phone +55 11 3215-4900  
E-Mail sac@sick.com.br

**Canada**

Phone +1 905 771 14 44  
E-Mail information@sick.com

**Ceská Republika**

Phone +420 2 57 91 18 50  
E-Mail sick@sick.cz

**China**

Phone +86 4000 121 000  
E-Mail info.china@sick.net.cn  
Phone +852-2153 6300  
E-Mail ghk@sick.com.hk

**Danmark**

Phone +45 45 82 64 00  
E-Mail sick@sick.dk

**Deutschland**

Phone +49 211 5301-301  
E-Mail kundenservice@sick.de

**España**

Phone +34 93 480 31 00  
E-Mail info@sick.es

**France**

Phone +33 1 64 62 35 00  
E-Mail info@sick.fr

**Great Britain**

Phone +44 (0)1727 831121  
E-Mail info@sick.co.uk

**India**

Phone +91-22-4033 8333  
E-Mail info@sick-india.com

**Israel**

Phone +972-4-6801000  
E-Mail info@sick-sensors.com

**Italia**

Phone +39 02 27 43 41  
E-Mail info@sick.it

**Japan**

Phone +81 (0)3 3358 1341  
E-Mail support@sick.jp

**Magyarország**

Phone +36 1 371 2680  
E-Mail office@sick.hu

**Nederlands**

Phone +31 (0)30 229 25 44  
E-Mail info@sick.nl

**Norge**

Phone +47 67 81 50 00  
E-Mail austefjord@sick.no

**Österreich**

Phone +43 (0)22 36 62 28 8-0  
E-Mail office@sick.at

**Polska**

Phone +48 22 837 40 50  
E-Mail info@sick.pl

**România**

Phone +40 356 171 120  
E-Mail office@sick.ro

**Russia**

Phone +7-495-775-05-30  
E-Mail info@sick.ru

**Schweiz**

Phone +41 41 619 29 39  
E-Mail contact@sick.ch

**Singapore**

Phone +65 6744 3732  
E-Mail admin@sicksgp.com.sg

**Slovenija**

Phone +386 (0)1-47 69 990  
E-Mail office@sick.si

**South Africa**

Phone +27 11 472 3733  
E-Mail info@sickautomation.co.za

**South Korea**

Phone +82 2 786 6321/4  
E-Mail info@sickkorea.net

**Suomi**

Phone +358-9-25 15 800  
E-Mail sick@sick.fi

**Sverige**

Phone +46 10 110 10 00  
E-Mail info@sick.se

**Taiwan**

Phone +886-2-2375-6288  
E-Mail sales@sick.com.tw

**Türkiye**

Phone +90 (216) 528 50 00  
E-Mail info@sick.com.tr

**United Arab Emirates**

Phone +971 (0) 4 8865 878  
E-Mail info@sick.ae

**USA/México**

Phone +1(952) 941-6780  
1 800-325-7425 – tollfree  
E-Mail info@sickusa.com

More representatives and agencies  
at [www.sick.com](http://www.sick.com)