



Fork sensors WFL

WFL50-40B416



Model Name > [WFL50-40B416](#)
Part No. > [6036825](#)



Illustration may differ

At a glance

- Very precise laser beam (Class 1 laser)
- Simple and accurate adjustment via teach-in
- Fast response time (max. 100 µs)
- Minimum detectable object size of 0.05 mm
- PNP and NPN switching output
- Light/dark switching function
- 21 different models with different fork widths and depths
- Rugged, IP 65 aluminum housing

Your benefits

- A highly precise laser beam ensures consistent measurement accuracy along the entire measuring range and reliable detection of the smallest objects
- A visible laser light spot enables easy alignment and fast adjustment
- Reliable and simple setting via teach-in ensures high process reliability
- A wide range of different fork sizes increases installation flexibility
- The aluminum housing meets all requirements for use in harsh industrial conditions



Features

Functional principle:	Optical detection principle
Fork width:	50 mm
Fork depth:	42 mm
MDO ¹⁾ :	0.05 mm
Label detection:	-
Light source:	Laser, Class 1, 670 nm
Adjustment:	Teach-in
Output function:	Light/darkswitching, selectable via button

¹⁾ Minimum detectable object

Mechanics/electronics

Supply voltage V_s ¹⁾ :	DC 10 V ... 30 V
Ripple ²⁾ :	< 10 %
Power consumption ³⁾ :	40 mA
Switching frequency ⁴⁾ :	10 kHz
Response time ⁵⁾ :	100 µs

Stability of response time:	± 20 µs
Output type:	NPN: HIGH = approx. VS / LOW ≤ 2 V PNP: HIGH = VS- ≤ 2 V / LOW approx. 0 V
Switching mode:	PNP/NPN
Output current I _{max.} :	100 mA
Initialization time:	100 ms
Connection type:	Connector M8, 4-pin
Ambient light safety:	Sunlight: ≤ 10,000 klx
Protection class ⁶⁾ :	III
Circuit protection:	VS connections reverse-polarity protected Output Q short-circuit protected Interference suppression
Enclosure rating:	IP 65
Weight:	Ca. 36 g ... 160 g ⁷⁾
Housing material:	Aluminum

¹⁾ Limit values, reverse-polarity protected, operation in short-circuit protected network, max. 8 A ²⁾ May not exceed or fall short of V_S tolerances ³⁾ Without load ⁴⁾
 With light/dark ratio 1:1 ⁵⁾ Signal transit time with resistive load ⁶⁾ Reference voltage DC 50 V ⁷⁾ Depending on fork width

Ambient data

Ambient temperature ¹⁾ :	Operation: -20 ... 50 °C Storage: -30 ... 80 °C
Shock load:	According to EN 60068-2-27
UL File-No.:	UL No. NRKH.E191603 & cUL No. NRKH7.E191603, CDRH-conform

¹⁾ Do not bend below 0 °C

Dimensional drawing

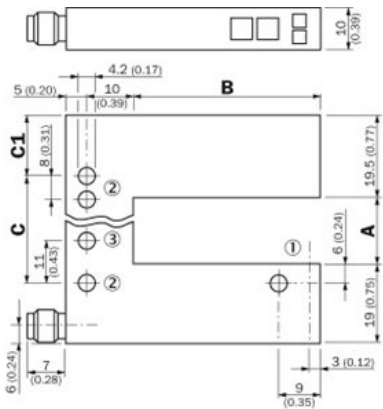

All dimensions in mm (inch)

Dimensions in mm (inch)

	A Fork width	B Fork depth	C	C1
WFL2	2 (0.08)	42/59/95 (1.65/2.32/3.74)	14 (0.55)	13.5 (0.53)
WFL5	5 (0.20)	42/59/95 (1.65/2.32/3.74)	14 (0.55)	15 (0.59)
WFL15	15 (0.59)	42/59/95 (1.65/2.32/3.74)	27 (1.06)	13.5 (0.53)
WFL30	30 (1.18)	42/59/95 (1.65/2.32/3.74)	42 (1.65)	13.5 (0.53)
WFL50	50 (1.97)	42/59/95 (1.65/2.32/3.74)	51 (2.01)	24.5 (0.96)
WFL80	80 (3.15)	42/59/95 (1.65/2.32/3.74)	81 (3.19)	24.5 (0.96)
WFL120	120 (4.72)	42/59/95 (1.65/2.32/3.74)	121 (4.76)	24.5 (0.96)

- |1| Optical axis
- |2| Mounting hole, \varnothing 4.2 mm
- |3| WFL50/80/120 only

Adjustments

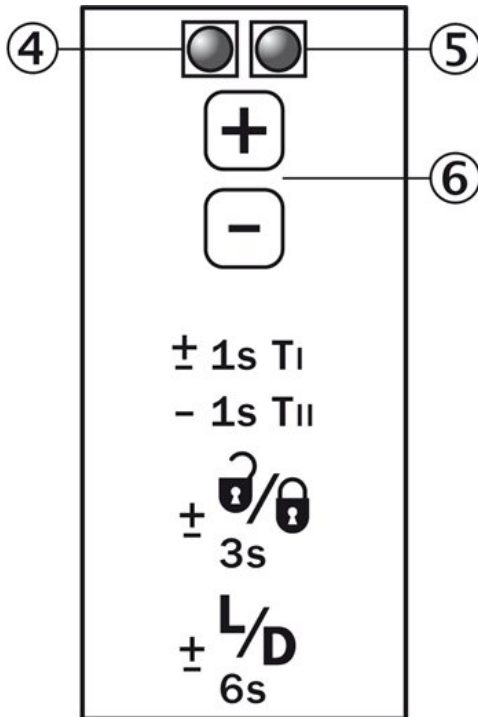

- |4| Function signal indicator (yellow), switching output
- |5| Function indicator (red)
- |6| "+" / "-" buttons and function button

Connection type

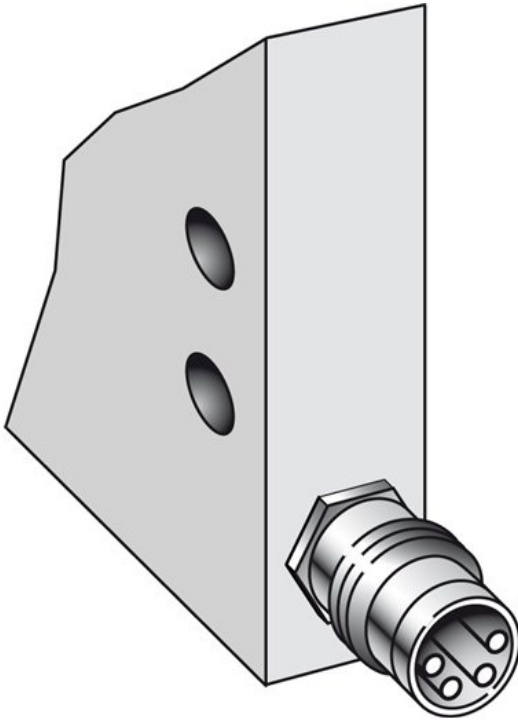

Connection diagram

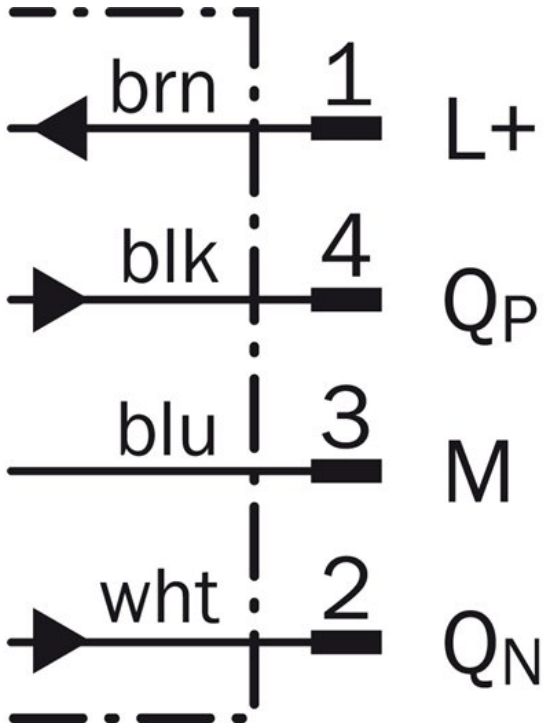

Australia

Phone +61 3 9457 0600
1800 334 802 – tollfree
E-Mail sales@sick.com.au

Belgium/Luxembourg

Phone +32 (0)2 466 55 66
E-Mail info@sick.be

Brasil

Phone +55 11 3215-4900
E-Mail sac@sick.com.br

Canada

Phone +1 905 771 14 44
E-Mail information@sick.com

Ceská Republika

Phone +420 2 57 91 18 50
E-Mail sick@sick.cz

China

Phone +86 4000 121 000
E-Mail info.china@sick.net.cn
Phone +852-2153 6300
E-Mail ghk@sick.com.hk

Danmark

Phone +45 45 82 64 00
E-Mail sick@sick.dk

Deutschland

Phone +49 211 5301-301
E-Mail kundenservice@sick.de

España

Phone +34 93 480 31 00
E-Mail info@sick.es

France

Phone +33 1 64 62 35 00
E-Mail info@sick.fr

Great Britain

Phone +44 (0)1727 831121
E-Mail info@sick.co.uk

India

Phone +91-22-4033 8333
E-Mail info@sick-india.com

Israel

Phone +972-4-6801000
E-Mail info@sick-sensors.com

Italia

Phone +39 02 27 43 41
E-Mail info@sick.it

Japan

Phone +81 (0)3 3358 1341
E-Mail support@sick.jp

Magyarország

Phone +36 1 371 2680
E-Mail office@sick.hu

Nederlands

Phone +31 (0)30 229 25 44
E-Mail info@sick.nl

Norge

Phone +47 67 81 50 00
E-Mail austefjord@sick.no

Österreich

Phone +43 (0)22 36 62 28 8-0
E-Mail office@sick.at

Polska

Phone +48 22 837 40 50
E-Mail info@sick.pl

România

Phone +40 356 171 120
E-Mail office@sick.ro

Russia

Phone +7-495-775-05-30
E-Mail info@sick.ru

Schweiz

Phone +41 41 619 29 39
E-Mail contact@sick.ch

Singapore

Phone +65 6744 3732
E-Mail admin@sicksgp.com.sg

Slovenija

Phone +386 (0)1-47 69 990
E-Mail office@sick.si

South Africa

Phone +27 11 472 3733
E-Mail info@sickautomation.co.za

South Korea

Phone +82 2 786 6321/4
E-Mail info@sickkorea.net

Suomi

Phone +358-9-25 15 800
E-Mail sick@sick.fi

Sverige

Phone +46 10 110 10 00
E-Mail info@sick.se

Taiwan

Phone +886-2-2375-6288
E-Mail sales@sick.com.tw

Türkiye

Phone +90 (216) 528 50 00
E-Mail info@sick.com.tr

United Arab Emirates

Phone +971 (0) 4 8865 878
E-Mail info@sick.ae

USA/México

Phone +1(952) 941-6780
1 800-325-7425 – tollfree
E-Mail info@sickusa.com

More representatives and agencies
at www.sick.com