



Luminescence sensors LUT3, LUT3-6

LUT3-650



Model Name > LUT3-650
Part No. > 1015398



At a glance

- Tough metal housing
- Sensing distance: 10, 20 or 50 mm
- Sensing distances selectable through interchangeable lenses
- Transmitter LED UV (375 nm)

Your benefits

- Sensitivity of the sensor can be infinitely adjusted using a potentiometer, saves time and reduces costs
- Filters ensure that background luminescence is reliably suppressed, ensuring greater process reliability
- Interchangeable lenses for different sensing distances provide flexibility



Features

Dimensions (L x W x H):	80 mm x 30.4 mm x 53 mm
Sensing distance ¹⁾ :	50 mm
Operating range:	30 mm 60 mm
Light source ^{2), 3)} :	UV-LED
Light emission:	Long side
Light spot size:	5 mm x 15 mm
Light spot direction:	Vertical
Receiving filters:	KV 418 (standard)
Receiving range:	450 nm ... 750 nm
Adjustment:	Manual (potentiometer)
Output function:	Light switching

¹⁾ From front edge of lens ²⁾ Average service life of 100,000 h at T_A = +25 °C ³⁾ Wave length: 375 nm

Mechanics/electronics

Supply voltage V _s ¹⁾ :	DC 12 V ... 30 V
Ripple ²⁾ :	< 2 Vpp
Power consumption ³⁾ :	< 60 mA
Switching frequency ⁴⁾ :	1.5 kHz
Response time ⁵⁾ :	350 µs
Output type:	PNP: HIGH = V _S - ≤ 3 V / LOW = approx. 0 V NPN: HIGH = approx. V _S / LOW ≤ 2 V
Switching mode:	PNP/NPN
Output current I _{max.} :	100 mA

Connection type: Connector M12, 4-pin
 Protection class ⁶⁾: II
 Circuit protection: Output Q short-circuit protected
 Interference suppression
 VS connections reverse-polarity protected
 Enclosure rating: IP 67
 Weight: Ca. 400 g
 Housing material: Zinc diecast

¹⁾ Limit values: operation in short-circuit protected network max. 8 A ²⁾ May not exceed or fall short of V_S tolerances ³⁾ Without load ⁴⁾ With light/dark ratio 1:1 ⁵⁾
⁶⁾ Reference voltage DC 50 V
 Signal transit time with resistive load

Ambient data

Ambient temperature: Operation: -10 ... 55 °C
 Storage: -25 ... 75 °C
 Shock load: According to IEC 60068

Dimensional drawing

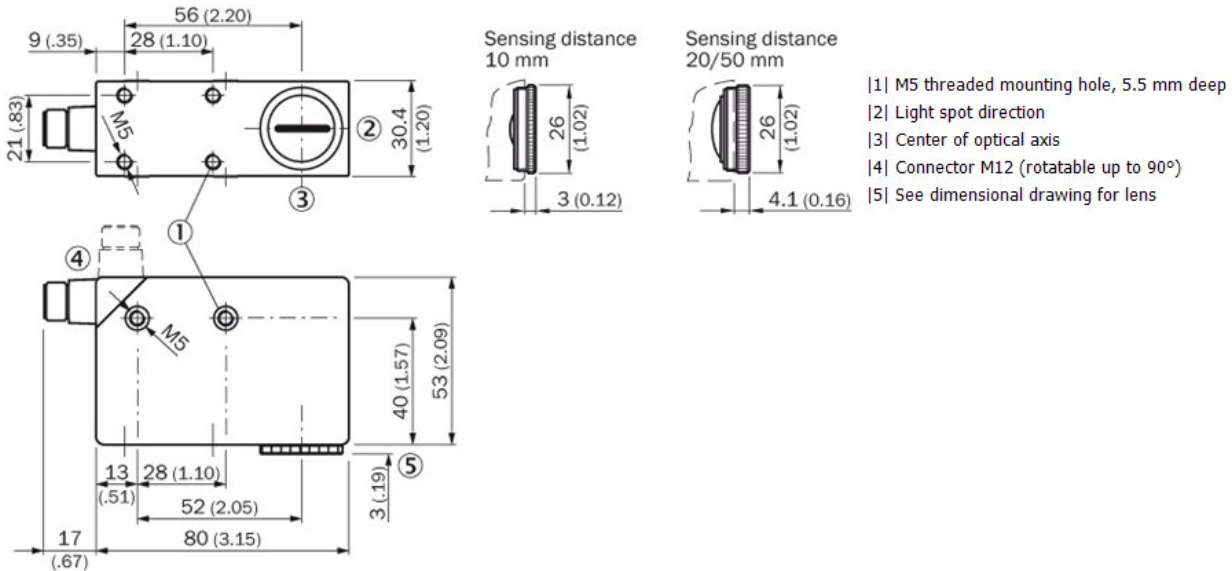

All dimensions in mm (inch)

Adjustments

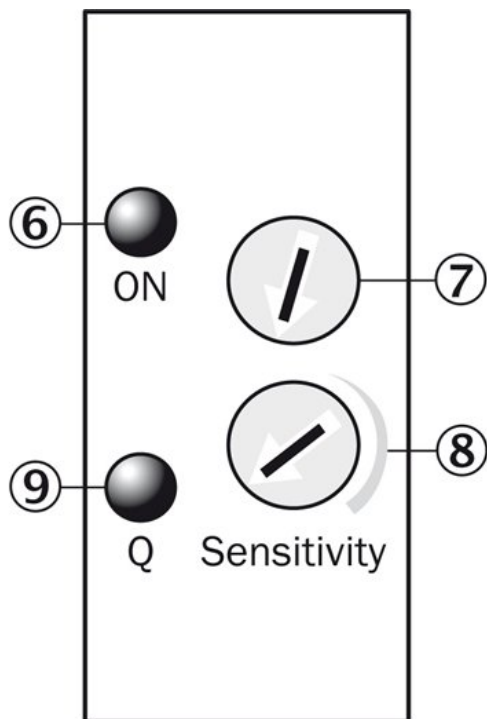

- |6| Function signal indicator (green)
- |7| not connected
- |8| Sensitivity adjustment
- |9| Function signal indicator (yellow), switching output

Connection type

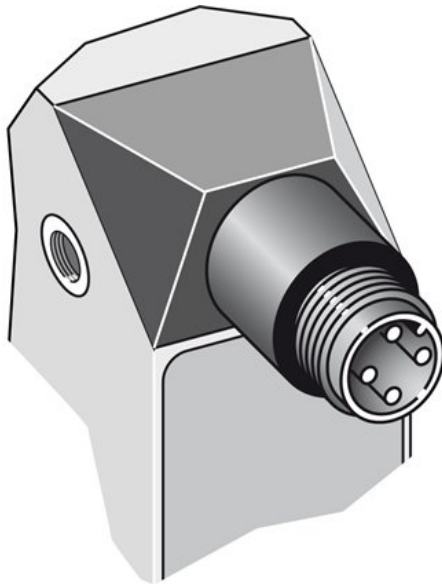

Connection diagram

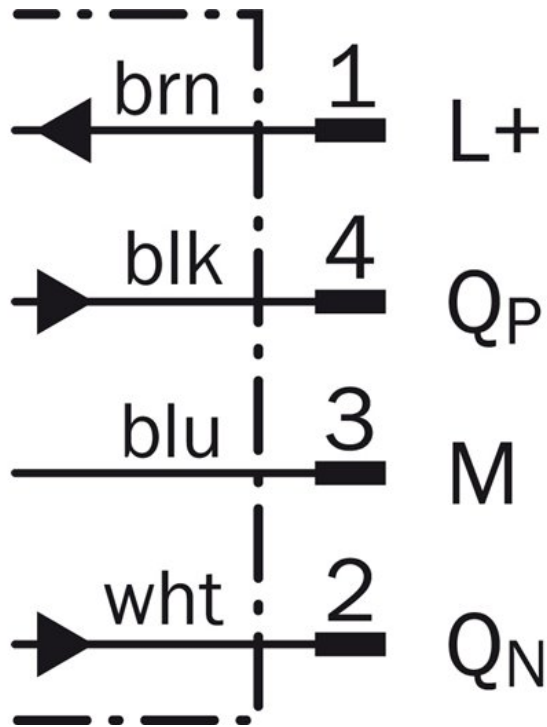

Light spot size

Sensing distance 10 mm

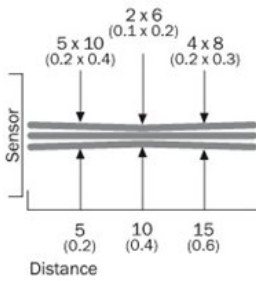

Sensing distance 20 mm

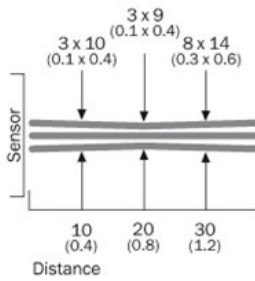

Sensing distance 50 mm

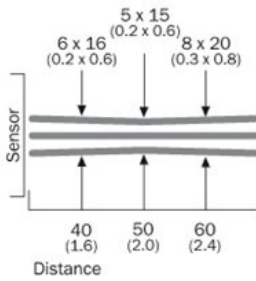

All dimensions in mm (inch)

Sensing distance

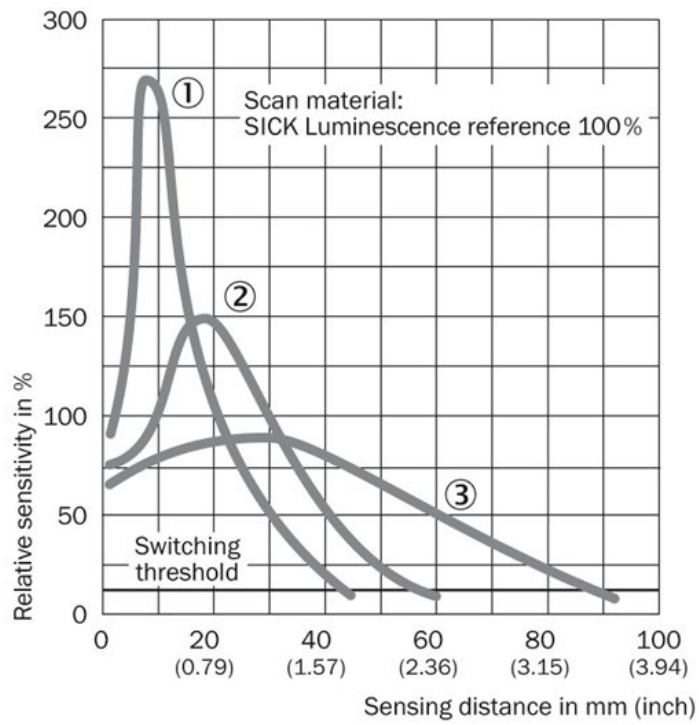

- |1| Sensing distance 10 mm
- |2| Sensing distance 20 mm
- |3| Sensing distance 50 mm

Australia

Phone +61 3 9457 0600
1800 334 802 – tollfree
E-Mail sales@sick.com.au

Belgium/Luxembourg

Phone +32 (0)2 466 55 66
E-Mail info@sick.be

Brasil

Phone +55 11 3215-4900
E-Mail sac@sick.com.br

Canada

Phone +1 905 771 14 44
E-Mail information@sick.com

Ceská Republika

Phone +420 2 57 91 18 50
E-Mail sick@sick.cz

China

Phone +86 4000 121 000
E-Mail info.china@sick.net.cn
Phone +852-2153 6300
E-Mail ghk@sick.com.hk

Danmark

Phone +45 45 82 64 00
E-Mail sick@sick.dk

Deutschland

Phone +49 211 5301-301
E-Mail kundenservice@sick.de

España

Phone +34 93 480 31 00
E-Mail info@sick.es

France

Phone +33 1 64 62 35 00
E-Mail info@sick.fr

Great Britain

Phone +44 (0)1727 831121
E-Mail info@sick.co.uk

India

Phone +91-22-4033 8333
E-Mail info@sick-india.com

Israel

Phone +972-4-6801000
E-Mail info@sick-sensors.com

Italia

Phone +39 02 27 43 41
E-Mail info@sick.it

Japan

Phone +81 (0)3 3358 1341
E-Mail support@sick.jp

Magyarország

Phone +36 1 371 2680
E-Mail office@sick.hu

Nederlands

Phone +31 (0)30 229 25 44
E-Mail info@sick.nl

Norge

Phone +47 67 81 50 00
E-Mail austefjord@sick.no

Österreich

Phone +43 (0)22 36 62 28 8-0
E-Mail office@sick.at

Polska

Phone +48 22 837 40 50
E-Mail info@sick.pl

România

Phone +40 356 171 120
E-Mail office@sick.ro

Russia

Phone +7-495-775-05-30
E-Mail info@sick.ru

Schweiz

Phone +41 41 619 29 39
E-Mail contact@sick.ch

Singapore

Phone +65 6744 3732
E-Mail admin@sicksgp.com.sg

Slovenija

Phone +386 (0)1-47 69 990
E-Mail office@sick.si

South Africa

Phone +27 11 472 3733
E-Mail info@sickautomation.co.za

South Korea

Phone +82 2 786 6321/4
E-Mail info@sickkorea.net

Suomi

Phone +358-9-25 15 800
E-Mail sick@sick.fi

Sverige

Phone +46 10 110 10 00
E-Mail info@sick.se

Taiwan

Phone +886-2-2375-6288
E-Mail sales@sick.com.tw

Türkiye

Phone +90 (216) 528 50 00
E-Mail info@sick.com.tr

United Arab Emirates

Phone +971 (0) 4 8865 878
E-Mail info@sick.ae

USA/México

Phone +1(952) 941-6780
1 800-325-7425 – tollfree
E-Mail info@sickusa.com

More representatives and agencies
at www.sick.com