



Photoelectric sensors
ZoneControl, Photoelectric proximity sensor,
Background suppression

RT-B2118



Model Name > [RT-B2118](#)
Part No. > [1063155](#)

At a glance

- Wide range of output options: PNP/NPN/FET, light/dark switching, and ON or OFF delay
- Potentiometer integrated into the power and status LED
- Integrated with SICK's patented optical ASIC: SIRIC
- AC power options
- IP 67 housing for harsh wash down environments

Your benefits

- 30% lower current draw reduces the size of the power supply and the yearly electric costs
- Next-generation SIRIC optical ASIC provides ambient light immunity, which eliminates false trips and ensures high productivity
- Variety of features and choices ensure application requirements are met
- Background suppression reduces mounting effort since no reflector is required
- Mounting between the rollers prevents damage and sensor interference



Illustration may differ



Features

Sensor/detection principle:	Photoelectric proximity sensor, Background suppression
Dimensions (W x H x D):	20.6 mm x 99.2 mm x 48.9 mm
Sensing range:	60 mm ... 900 mm
Type of light:	Infrared light
Light source:	LED ¹⁾
Angle of dispersion:	7 °
Adjustment:	Potentiometer, 9 turns
Light spot size (distance):	Ø 20 mm (500 mm)
Max. number of sensors::	Ca. 30, Ca. 50 ^{2) 3)}

¹⁾ Average service life of 100,000 h at T_A = +25 °C ²⁾ When power from the end of the IR daisy chain ³⁾ When power from center of the IR daisy chain

Mechanics/electronics

Supply voltage:	10 V DC ... 30 V DC ¹⁾
Ripple:	< 5 Vpp ²⁾
Power consumption:	< 20 mA ³⁾
Output type:	PNP NPN
Switching mode:	Dark switching

Output current I _{max} :	≤ 100 mA
Response time:	2 ms
Switching frequency:	± 250 Hz
Connection type:	Cable, 4-wire, 3 m ⁴⁾
Circuit protection:::	A, C, D ^{5) 6) 7)}
Protection class:	III
Weight:	175 g
Housing material:	ABS, Plastic
Enclosure rating:	IP 67
Ambient operating temperature:	+10 °C ... +55 °C
Ambient storage temperature:	-40 °C ... +75 °C
Shock/vibration:	According to IEC 68
UL File No.:	NRKH.E189383 & NRKH7.E189383
Signal voltage PNP HIGH/LOW:	Approx. V _S - 0.5 V / 0 V
Signal voltage NPN HIGH/LOW:	Approx. V _S / < 2.0 V

1) Limit values 2) May not exceed or fall short of V_S tolerances 3) Without load and valve deenergized 4) Do not bend below 0 °C 5) A = V_S connections reverse-polarity protected 6) C = interference suppression 7) D = outputs overcurrent and short-circuit protected

Dimensional drawing

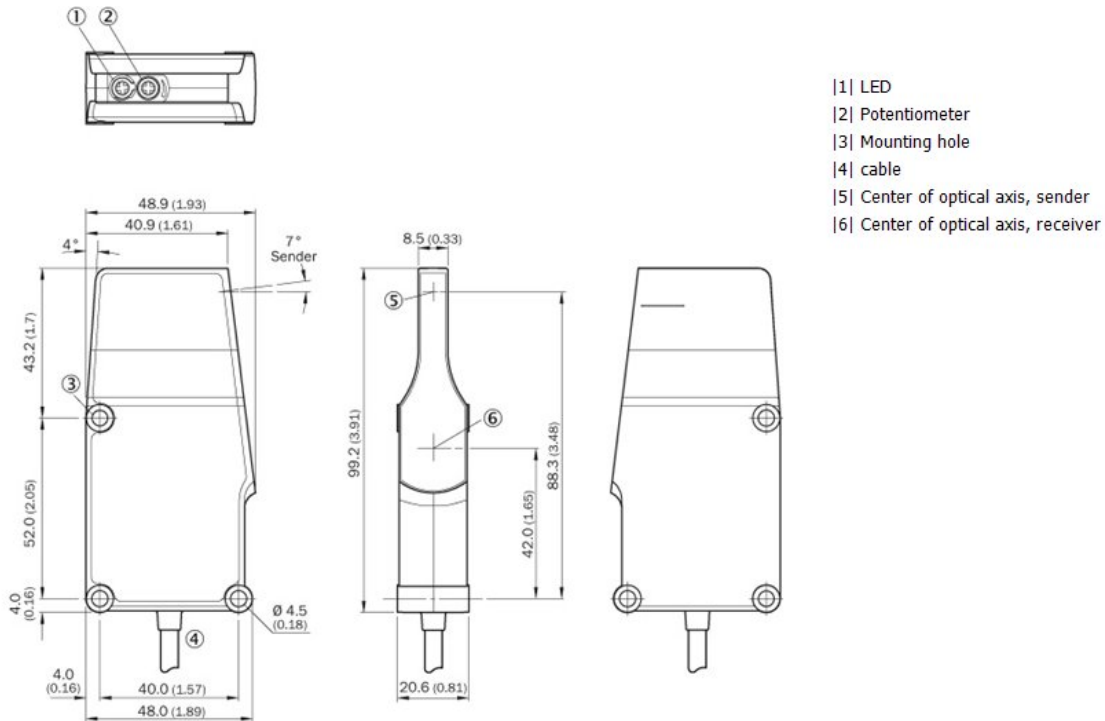

Connection diagram

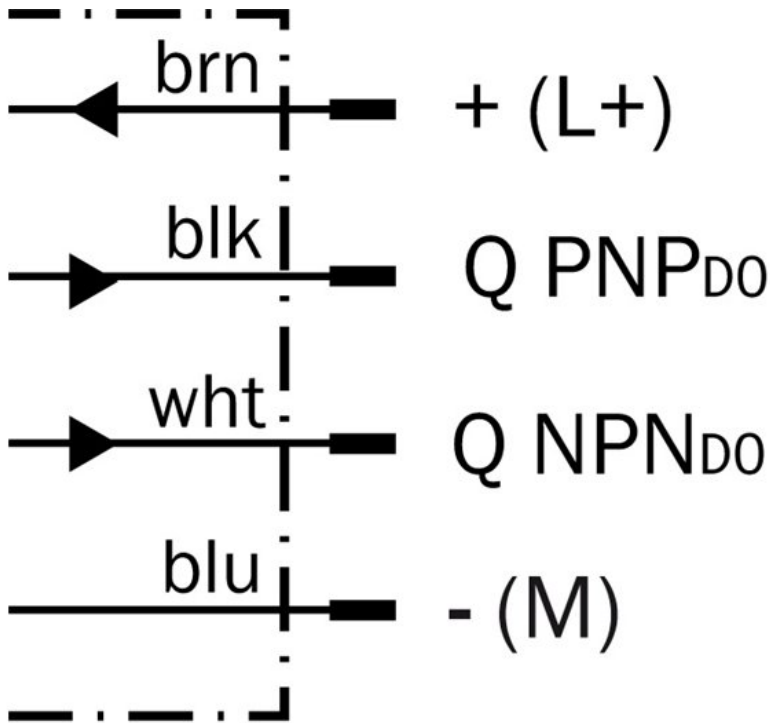

Characteristic curve

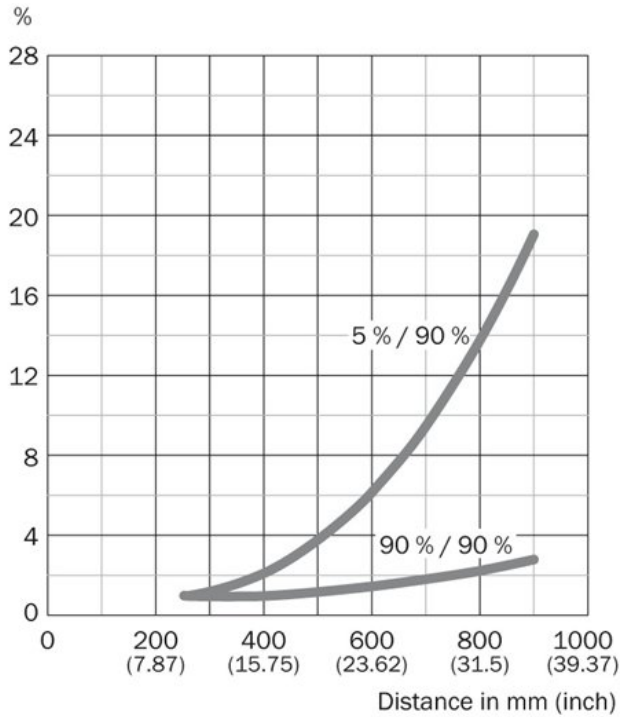

Australia

Phone +61 3 9457 0600
1800 33 48 02 – tollfree
E-Mail sales@sick.com.au

Belgium/Luxembourg

Phone +32 (0)2 466 55 66
E-Mail info@sick.be

Brasil

Phone +55 11 3215-4900
E-Mail marketing@sick.com.br

Canada

Phone +1 905 771 14 44
E-Mail information@sick.com

Česká republika

Phone +420 2 57 91 18 50
E-Mail sick@sick.cz

China

Phone +86 4000 121 000
E-Mail info.china@sick.net.cn
Phone +852-2153 6300
E-Mail ghk@sick.com.hk

Danmark

Phone +45 45 82 64 00
E-Mail sick@sick.dk

Deutschland

Phone +49 211 5301-301
E-Mail info@sick.de

España

Phone +34 93 480 31 00
E-Mail info@sick.es

France

Phone +33 1 64 62 35 00
E-Mail info@sick.fr

Great Britain

Phone +44 (0)1727 831121
E-Mail info@sick.co.uk

India

Phone +91-22-4033 8333
E-Mail info@sick-india.com

Israel

Phone +972-4-6881000
E-Mail info@sick-sensors.com

Italia

Phone +39 02 27 43 41
E-Mail info@sick.it

Japan

Phone +81 (0)3 5309 2112
E-Mail support@sick.jp

Magyarország

Phone +36 1 371 2680
E-Mail office@sick.hu

Nederland

Phone +31 (0)30 229 25 44
E-Mail info@sick.nl

Norge

Phone +47 67 81 50 00
E-Mail sick@sick.no

Österreich

Phone +43 (0)22 36 62 28 8-0
E-Mail office@sick.at

Polska

Phone +48 22 837 40 50
E-Mail info@sick.pl

România

Phone +40 356 171 120
E-Mail office@sick.ro

Russia

Phone +7-495-775-05-30
E-Mail info@sick.ru

Schweiz

Phone +41 41 619 29 39
E-Mail contact@sick.ch

Singapore

Phone +65 6744 3732
E-Mail sales.gsg@sick.com

Slovenija

Phone +386 (0)1-47 69 990
E-Mail office@sick.si

South Africa

Phone +27 11 472 3733
E-Mail info@sickautomation.co.za

South Korea

Phone +82 2 786 6321/4
E-Mail info@sickkorea.net

Suomi

Phone +358-9-25 15 800
E-Mail sick@sick.fi

Sverige

Phone +46 10 110 10 00
E-Mail info@sick.se

Taiwan

Phone +886 2 2375-6288
E-Mail sales@sick.com.tw

Türkiye

Phone +90 (216) 528 50 00
E-Mail info@sick.com.tr

United Arab Emirates

Phone +971 (0) 4 88 65 878
E-Mail info@sick.ae

USA/México

Phone +1(952) 941-6780
1 (800) 325-7425 – tollfree
E-Mail info@sickusa.com

More representatives and agencies
at www.sick.com