



Photoelectric sensors  
W190 Laser High Grade Glass, Photoelectric  
retro-reflective sensor, autocollimation

WLG190T-P420



**Model Name** > [WLG190T-P420](#)  
**Part No.** > [6022830](#)



*Illustration may differ*

**At a glance**

- Configurable laser photoelectric sensor with display
- Continuous threshold adaption enables detection of transparent objects
- Precise autocollimation optics
- Programmable output: light/dark switching and switching delay

**Your benefits**

- Quick and easy alignment due to red light laser, class 2
- Fast configuration via display with menu navigation
- Easy-to-use setup options with a wide range of functions
- Simple sensing range adjustment via a teach-in pushbutton



**Features**

Sensor/detection principle:	Photoelectric retro-reflective sensor, autocollimation
Dimensions (W x H x D):	15 mm x 44.4 mm x 30 mm
Housing design (light emission):	Rectangular
Sensing range max.:	0.01 m ... 5.5 m <sup>1)</sup>
Type of light:	Visible red light
Light source:	Laser
Light spot (distance):	15 mm (1 m)
Laser class:	2
Adjustment of operating distance:	Teach
Teach-in:	Single teach-in button, Menu-controlled
Time type:	Programmable Programmable: 0 ... 10 s
Delay time:	Nor: normal mode: Ond: On delay mode, reactivation delay: OFd: Off-delay mode, release delay: OnE: One Shot Mode, ONE SHOT:
Display:	Sender power, reflectivity, switching threshold, distance, mode

<sup>1)</sup> P250F

**Mechanics/electronics**

Supply voltage:	10 V DC ... 30 V DC <sup>1)</sup>
Ripple:	± 10 % <sup>2)</sup>
Power consumption:	≤ 40 mA <sup>3)</sup>

Output type:	PNP, Light/dark-switching, programmable
Output current I <sub>max</sub> ::	< 100 mA
Response time::	0.7 ms 2 ms <sup>4) 5)</sup> 5 ms
Switching frequency::	700 Hz 200 Hz <sup>6) 7)</sup> 100 Hz
Connection type:	Connector M8, 4-pin
Circuit protection::	A, D <sup>8) 9)</sup>
Protection class:	III <sup>10)</sup>
Weight:	120 g
Polarisation filter:	✓
Housing material:	ABS
Optics material:	PMMA
Enclosure rating:	IP 67
Items supplied:	Reflector P250F
Special feature:	For transparent objects
Ambient operating temperature:	-10 °C ... 40 °C
Ambient storage temperature:	-20 °C ... 60 °C

1) Limit values 2) May not exceed or fall short of V<sub>S</sub> tolerances 3) Without load 4) Signal transit time with resistive load 5) 7) Programmable 6) With light/dark ratio  
 1:1 <sup>8)</sup> A = V<sub>S</sub> connections reverse-polarity protected <sup>9)</sup> D = outputs overcurrent and short-circuit protected <sup>10)</sup> Reference voltage 50 V DC

## Dimensional drawing

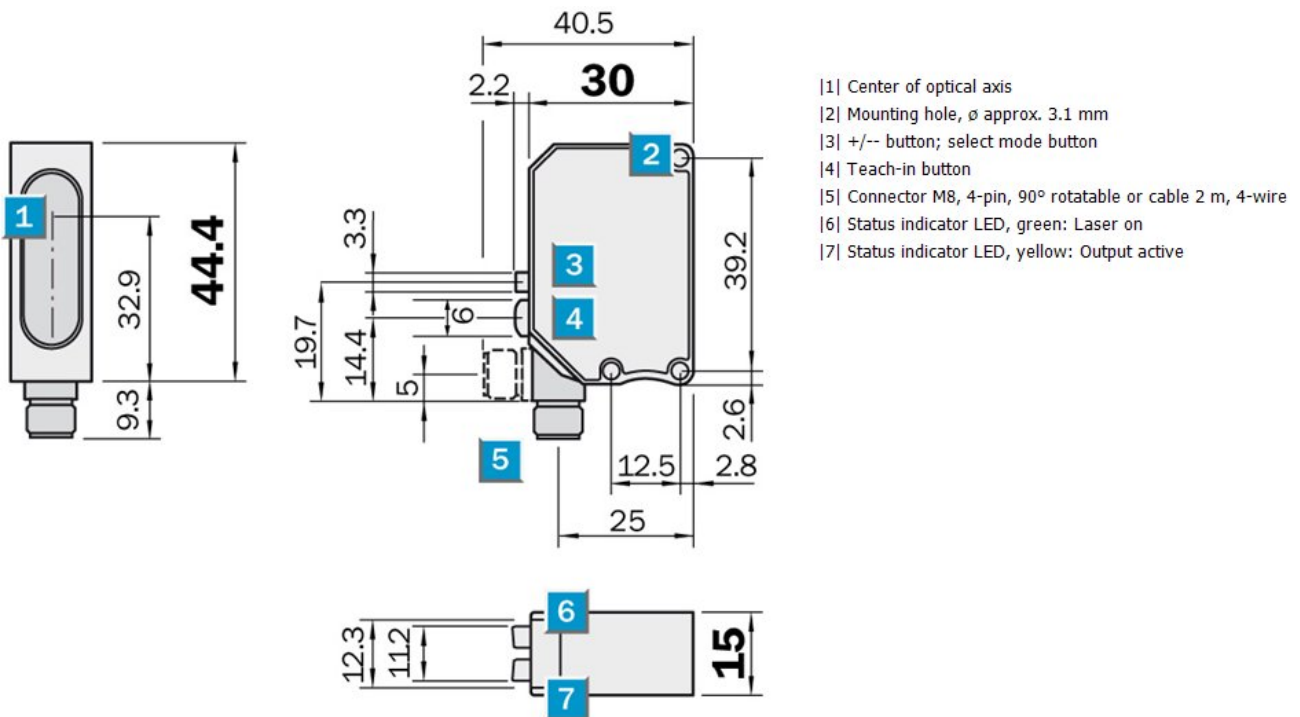

## Adjustments possible

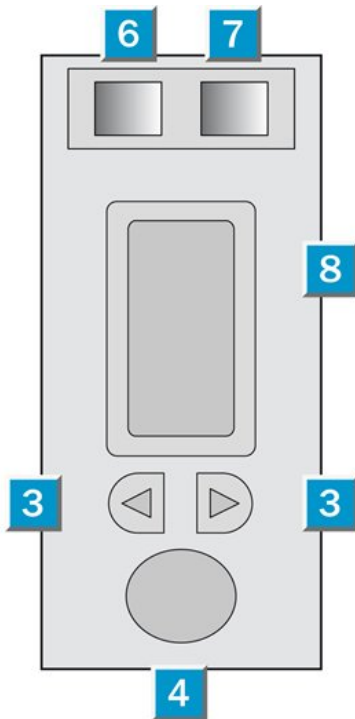

- [3] +/- button; select mode button
- [4] Teach-in button
- [6] Status indicator LED, green: Laser on
- [7] Status indicator LED, yellow: Output active
- [8] Numerical Display

## Connection diagram

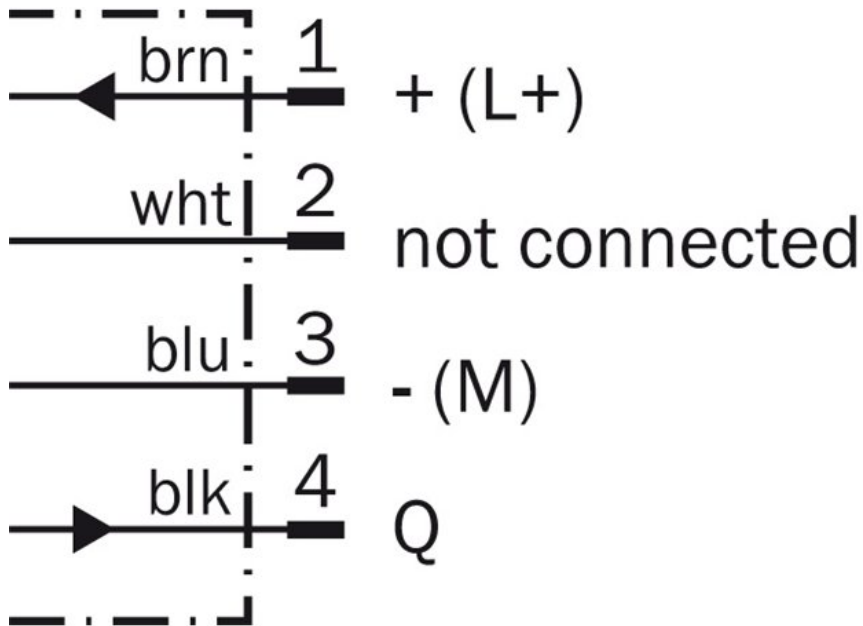

**Characteristic curve**

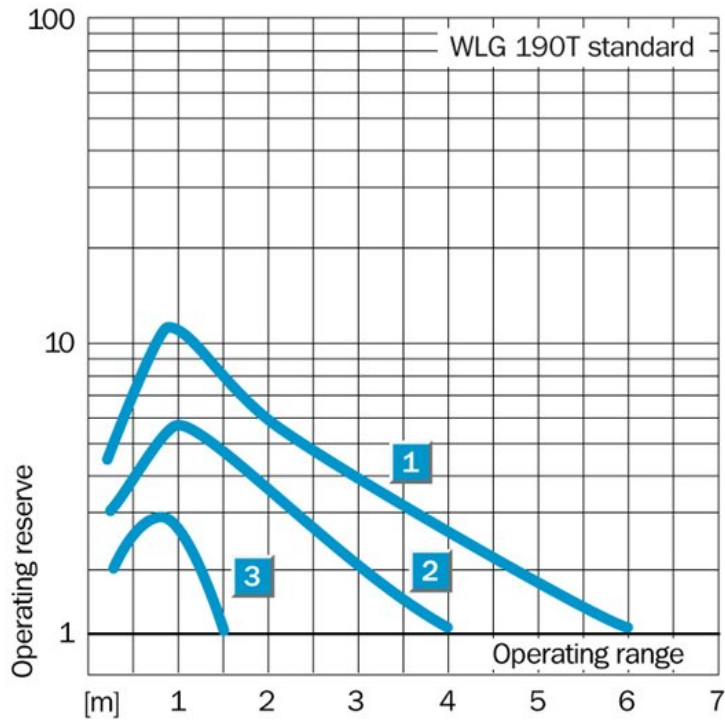

**Sensing range diagram**

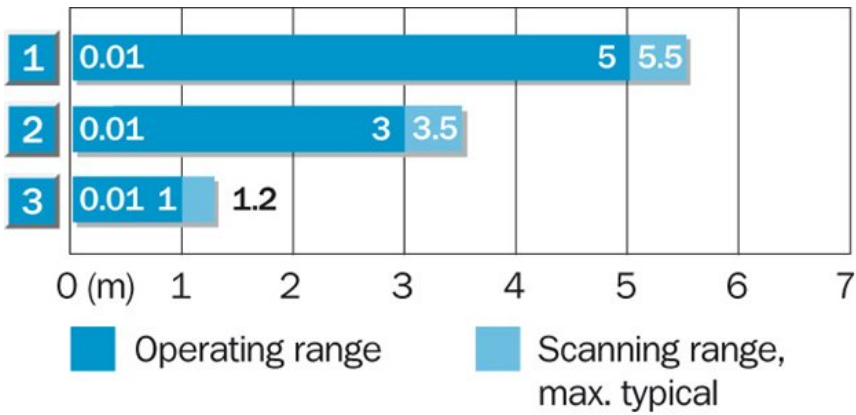

Reflector type	Operating range
1 P 250 F	0.01 ... 5 m
2 PL 20 F	0.01 ... 3 m
3 PL 10 F	0.01 ... 1 m

**Connection type**

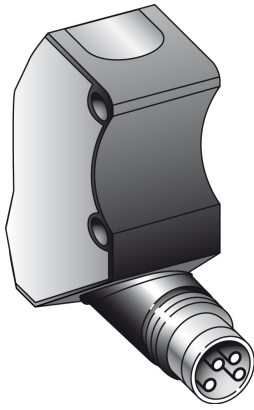

**Light spot size**

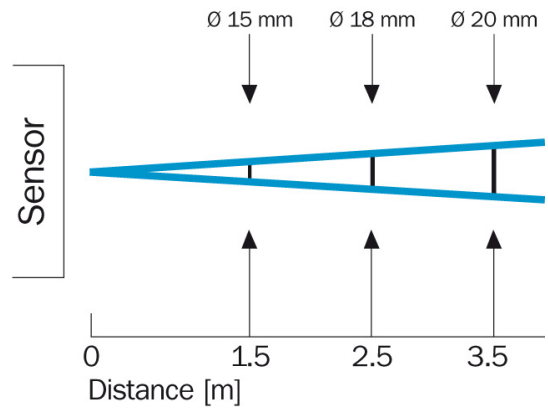

**Australia**

Phone +61 3 9457 0600  
1800 334 802 – tollfree  
E-Mail sales@sick.com.au

**Belgium/Luxembourg**

Phone +32 (0)2 466 55 66  
E-Mail info@sick.be

**Brasil**

Phone +55 11 3215-4900  
E-Mail sac@sick.com.br

**Canada**

Phone +1 905 771 14 44  
E-Mail information@sick.com

**Ceská Republika**

Phone +420 2 57 91 18 50  
E-Mail sick@sick.cz

**China**

Phone +86 4000 121 000  
E-Mail info.china@sick.net.cn  
Phone +852-2153 6300  
E-Mail ghk@sick.com.hk

**Danmark**

Phone +45 45 82 64 00  
E-Mail sick@sick.dk

**Deutschland**

Phone +49 211 5301-301  
E-Mail kundenservice@sick.de

**España**

Phone +34 93 480 31 00  
E-Mail info@sick.es

**France**

Phone +33 1 64 62 35 00  
E-Mail info@sick.fr

**Great Britain**

Phone +44 (0)1727 831121  
E-Mail info@sick.co.uk

**India**

Phone +91-22-4033 8333  
E-Mail info@sick-india.com

**Israel**

Phone +972-4-6801000  
E-Mail info@sick-sensors.com

**Italia**

Phone +39 02 27 43 41  
E-Mail info@sick.it

**Japan**

Phone +81 (0)3 3358 1341  
E-Mail support@sick.jp

**Magyarország**

Phone +36 1 371 2680  
E-Mail office@sick.hu

**Nederlands**

Phone +31 (0)30 229 25 44  
E-Mail info@sick.nl

**Norge**

Phone +47 67 81 50 00  
E-Mail austefjord@sick.no

**Österreich**

Phone +43 (0)22 36 62 28 8-0  
E-Mail office@sick.at

**Polska**

Phone +48 22 837 40 50  
E-Mail info@sick.pl

**România**

Phone +40 356 171 120  
E-Mail office@sick.ro

**Russia**

Phone +7-495-775-05-30  
E-Mail info@sick.ru

**Schweiz**

Phone +41 41 619 29 39  
E-Mail contact@sick.ch

**Singapore**

Phone +65 6744 3732  
E-Mail admin@sicksgp.com.sg

**Slovenija**

Phone +386 (0)1-47 69 990  
E-Mail office@sick.si

**South Africa**

Phone +27 11 472 3733  
E-Mail info@sickautomation.co.za

**South Korea**

Phone +82 2 786 6321/4  
E-Mail info@sickkorea.net

**Suomi**

Phone +358-9-25 15 800  
E-Mail sick@sick.fi

**Sverige**

Phone +46 10 110 10 00  
E-Mail info@sick.se

**Taiwan**

Phone +886-2-2375-6288  
E-Mail sales@sick.com.tw

**Türkiye**

Phone +90 (216) 528 50 00  
E-Mail info@sick.com.tr

**United Arab Emirates**

Phone +971 (0) 4 8865 878  
E-Mail info@sick.ae

**USA/México**

Phone +1(952) 941-6780  
1 800-325-7425 – tollfree  
E-Mail info@sickusa.com

More representatives and agencies  
at [www.sick.com](http://www.sick.com)