



Photoelectric sensors
W190 Laser High Grade Glass, Photoelectric
retro-reflective sensor, autocollimation

WLG190T-N420



Model Name > [WLG190T-N420](#)
Part No. > [6022826](#)



Illustration may differ

At a glance

- Configurable laser photoelectric sensor with display
- Continuous threshold adaption enables detection of transparent objects
- Precise autocollimation optics
- Programmable output: light/dark switching and switching delay

Your benefits

- Quick and easy alignment due to red light laser, class 2
- Fast configuration via display with menu navigation
- Easy-to-use setup options with a wide range of functions
- Simple sensing range adjustment via a teach-in pushbutton



Features

Sensor/detection principle:	Photoelectric retro-reflective sensor, autocollimation
Dimensions (W x H x D):	15 mm x 44.4 mm x 30 mm
Housing design (light emission):	Rectangular
Sensing range max.:	0.01 m ... 5.5 m ¹⁾
Type of light:	Visible red light
Light source:	Laser
Light spot (distance):	15 mm (1 m)
Laser class:	2
Adjustment of operating distance:	Teach
Teach-in:	Single teach-in button, Menu-controlled
Time type:	Programmable Programmable: 0 ... 10 s
Delay time:	Nor: normal mode: Ond: On delay mode, reactivation delay: OFd: Off-delay mode, release delay: OnE: One Shot Mode, ONE SHOT:
Display:	Sender power, reflectivity, switching threshold, distance, mode

¹⁾ P250F

Mechanics/electronics

Supply voltage:	10 V DC ... 30 V DC ¹⁾
Ripple:	± 10 % ²⁾
Power consumption:	≤ 40 mA ³⁾

Output type:	NPN, Light/dark-switching, programmable
Output current I _{max} ::	< 100 mA
Response time::	0.7 ms 2 ms ^{4) 5)} 5 ms
Switching frequency::	700 Hz 200 Hz ^{6) 7)} 100 Hz
Connection type:	Connector M8, 4-pin
Circuit protection::	A, D ^{8) 9)}
Protection class:	III ¹⁰⁾
Weight:	120 g
Polarisation filter:	✓
Housing material:	ABS
Optics material:	PMMA
Enclosure rating:	IP 67
Items supplied:	Reflector P250F
Special feature:	For transparent objects
Ambient operating temperature:	-10 °C ... 40 °C
Ambient storage temperature:	-20 °C ... 60 °C

1) Limit values 2) May not exceed or fall short of V_S tolerances 3) Without load 4) Signal transit time with resistive load 5) 7) Programmable 6) With light/dark ratio
 1:1 ⁸⁾ A = V_S connections reverse-polarity protected ⁹⁾ D = outputs overcurrent and short-circuit protected ¹⁰⁾ Reference voltage 50 V DC

Dimensional drawing

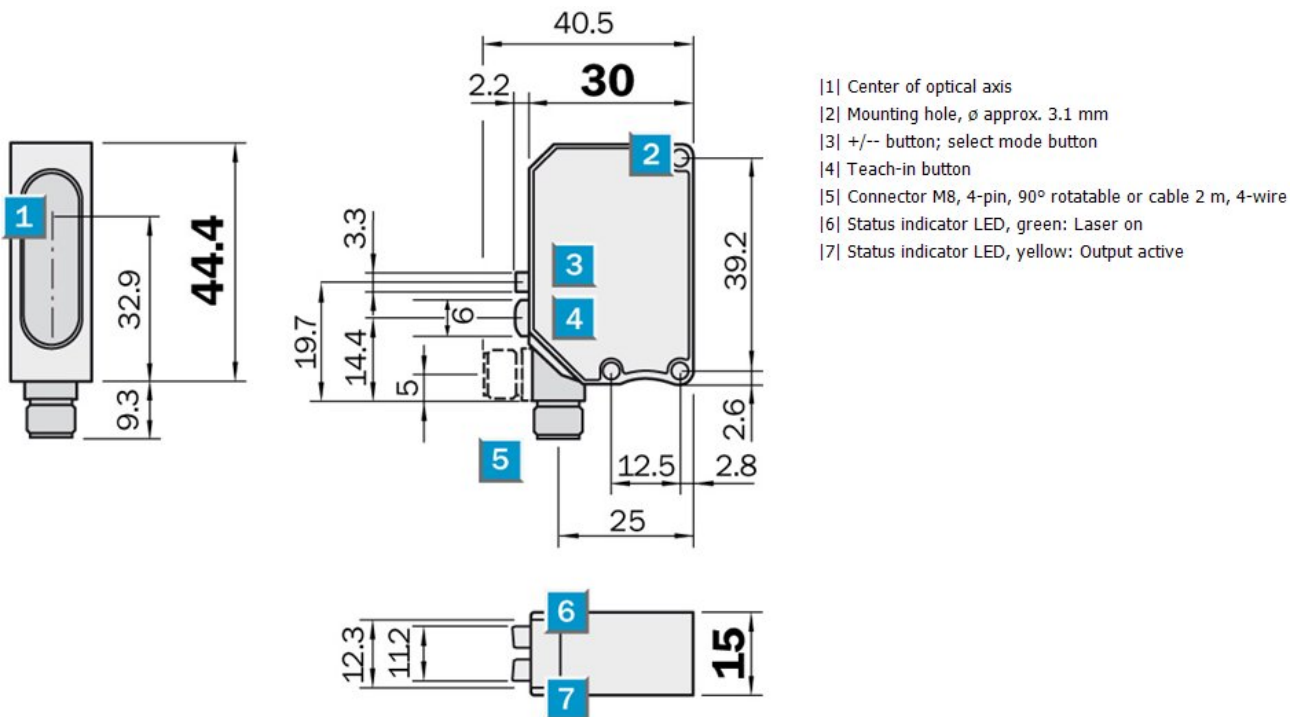

Adjustments possible

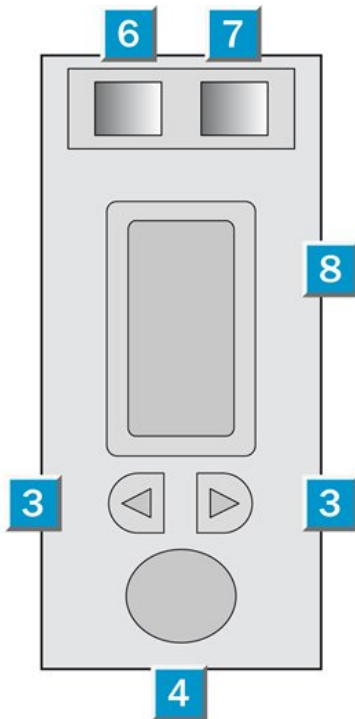

- |3| +/- button; select mode button
- |4| Teach-in button
- |6| Status indicator LED, green: Laser on
- |7| Status indicator LED, yellow: Output active
- |8| Numerical Display

Connection diagram

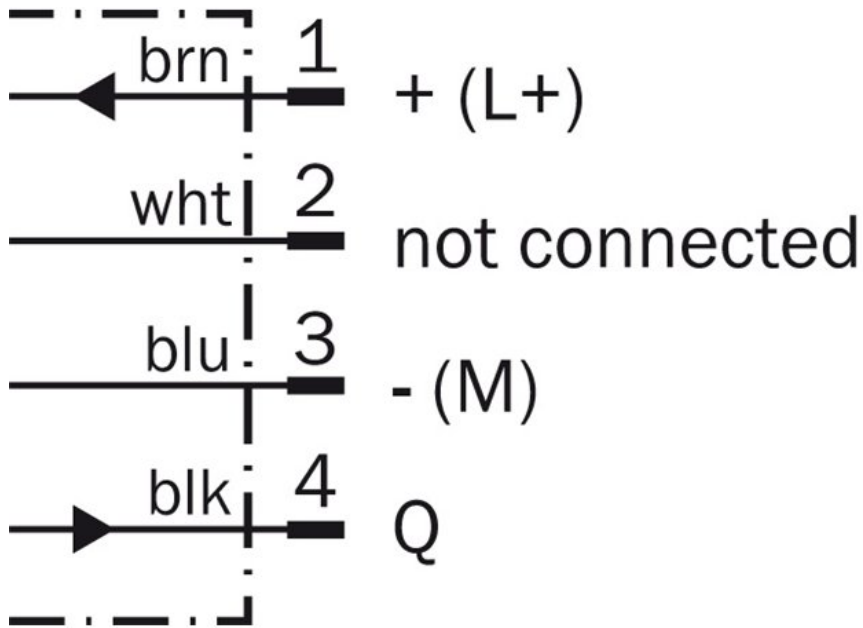

Characteristic curve

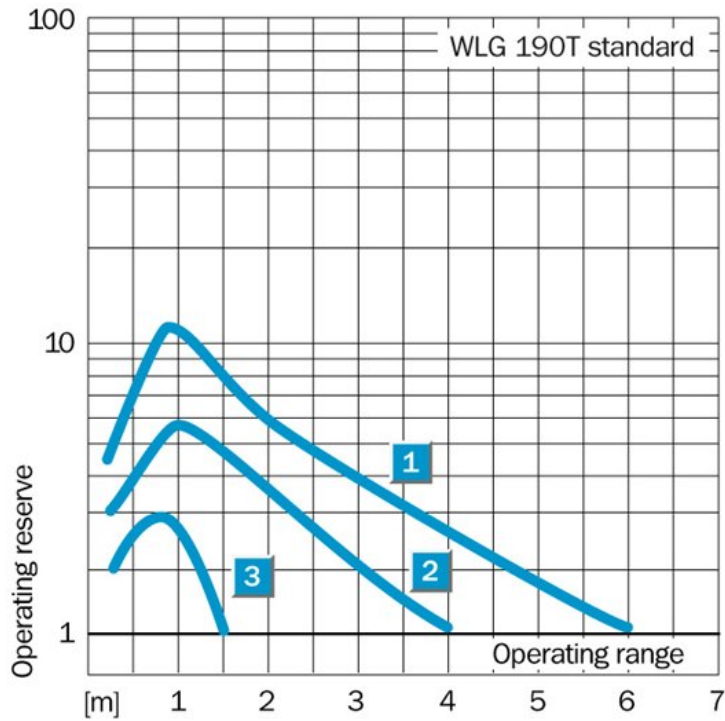

Sensing range diagram

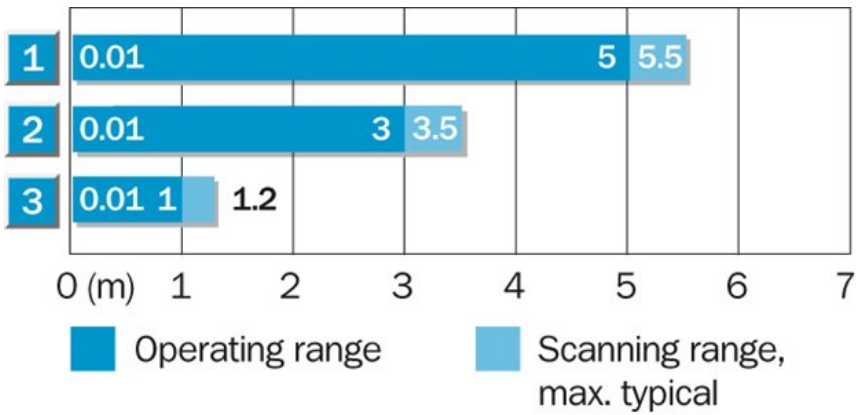

Reflector type	Operating range
1 P 250 F	0.01 ... 5 m
2 PL 20 F	0.01 ... 3 m
3 PL 10 F	0.01 ... 1 m

Connection type

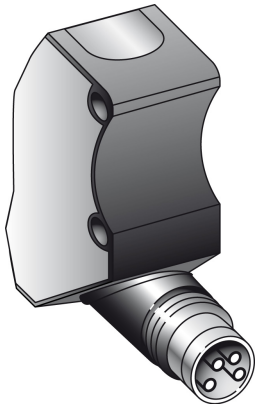

Light spot size

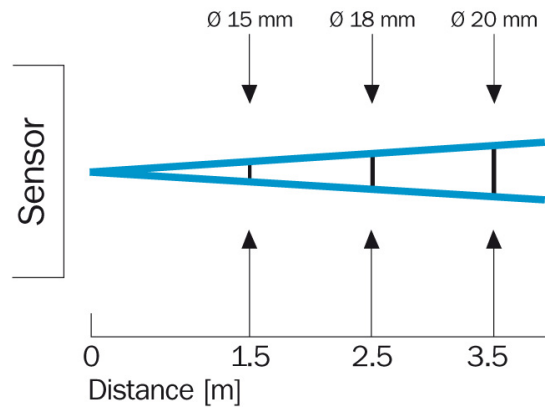

Australia

Phone +61 3 9457 0600
1800 334 802 – tollfree
E-Mail sales@sick.com.au

Belgium/Luxembourg

Phone +32 (0)2 466 55 66
E-Mail info@sick.be

Brasil

Phone +55 11 3215-4900
E-Mail sac@sick.com.br

Canada

Phone +1 905 771 14 44
E-Mail information@sick.com

Ceská Republika

Phone +420 2 57 91 18 50
E-Mail sick@sick.cz

China

Phone +86 4000 121 000
E-Mail info.china@sick.net.cn
Phone +852-2153 6300
E-Mail ghk@sick.com.hk

Danmark

Phone +45 45 82 64 00
E-Mail sick@sick.dk

Deutschland

Phone +49 211 5301-301
E-Mail kundenservice@sick.de

España

Phone +34 93 480 31 00
E-Mail info@sick.es

France

Phone +33 1 64 62 35 00
E-Mail info@sick.fr

Great Britain

Phone +44 (0)1727 831121
E-Mail info@sick.co.uk

India

Phone +91-22-4033 8333
E-Mail info@sick-india.com

Israel

Phone +972-4-6801000
E-Mail info@sick-sensors.com

Italia

Phone +39 02 27 43 41
E-Mail info@sick.it

Japan

Phone +81 (0)3 3358 1341
E-Mail support@sick.jp

Magyarország

Phone +36 1 371 2680
E-Mail office@sick.hu

Nederlands

Phone +31 (0)30 229 25 44
E-Mail info@sick.nl

Norge

Phone +47 67 81 50 00
E-Mail austefjord@sick.no

Österreich

Phone +43 (0)22 36 62 28 8-0
E-Mail office@sick.at

Polska

Phone +48 22 837 40 50
E-Mail info@sick.pl

România

Phone +40 356 171 120
E-Mail office@sick.ro

Russia

Phone +7-495-775-05-30
E-Mail info@sick.ru

Schweiz

Phone +41 41 619 29 39
E-Mail contact@sick.ch

Singapore

Phone +65 6744 3732
E-Mail admin@sicksgp.com.sg

Slovenija

Phone +386 (0)1-47 69 990
E-Mail office@sick.si

South Africa

Phone +27 11 472 3733
E-Mail info@sickautomation.co.za

South Korea

Phone +82 2 786 6321/4
E-Mail info@sickkorea.net

Suomi

Phone +358-9-25 15 800
E-Mail sick@sick.fi

Sverige

Phone +46 10 110 10 00
E-Mail info@sick.se

Taiwan

Phone +886-2-2375-6288
E-Mail sales@sick.com.tw

Türkiye

Phone +90 (216) 528 50 00
E-Mail info@sick.com.tr

United Arab Emirates

Phone +971 (0) 4 8865 878
E-Mail info@sick.ae

USA/México

Phone +1(952) 941-6780
1 800-325-7425 – tollfree
E-Mail info@sickusa.com

More representatives and agencies
at www.sick.com