



Photoelectric sensors
W18-3, Through-beam photoelectric sensor

WS/WE18-3N130



Model Name > [WS/WE18-3N130](#)
Part No. > [1025925](#)



Illustration may differ

At a glance

- Sender LED with visible red light
- High operational reliability
- Immune to ambient light
- Test input for system diagnostics
- Rugged plastic housing

Your benefits

- Quick installation due to visible red light saves time
- Very high operating reserves for trouble-free operation, even at long distances
- Reliable operation due to integrated system diagnostics
- High availability in the field



Features

Sensor/detection principle:	Through-beam photoelectric sensor
Dimensions (W x H x D):	17.6 mm x 75.5 mm x 33.5 mm
Housing design (light emission):	Rectangular, Slim
Sensing range max.:	0 m ... 20 m
Type of light:	Visible red light
Light source:	LED ¹⁾
Wave length:	645 nm
Angle of dispersion:	1.5 °
Adjustment:	Potentiometer, 1-turn
Light spot size (distance):	Ø 450 mm (15 m)
Continuous threshold adaption:	-

¹⁾ Average service life of 100,000 h at T_A = +25 °C

Mechanics/electronics

Supply voltage:	10 V DC ... 30 V DC ¹⁾
Ripple:	< 5 Vpp ²⁾
Power consumption, sender:	< 45 mA ³⁾
Power consumption, receiver:	< 35 mA ⁴⁾
Output type:	NPN
Output function:	Complementary
Switching mode:	Light/dark-switching
Output current I _{max.} :	100 mA

Response time:	< 500 μ s ⁵⁾
Switching frequency:	1,000 Hz ⁶⁾
Angle of reception:	2°
Connection type:	Cable, 4-wire, 2 m ⁷⁾
Cable material:	PVC
Circuit protection:::	A, C, D ^{8) 9) 10)}
Weight:	120 g
Housing material:	ABS, Plastic
Optics material:	PMMA
Enclosure rating:	IP 67
Test input sender off:	TE to 0 V
Ambient operating temperature:	-40 °C ... 60 °C
Ambient storage temperature:	-40 °C ... 75 °C
Part number of individual components:	Receiver, WE18-3N130, 2031004, Sender, WS18-3D130, 2030985
UL File No.:	NRKH.E181493 & NRKH7.E181493

1) Limit values, operation in short-circuit protected network max. 8 A resistive load⁶⁾ With light/dark ratio 1:1⁷⁾ Do not bend below 0 °C⁸⁾ A = V_S connections reverse-polarity protected⁹⁾ C = interference suppression¹⁰⁾ D = outputs
 2) May not exceed or fall short of V_S tolerances^{3) 4)} Without load⁵⁾ Signal transit time with
 overcurrent and short-circuit protected

Dimensional drawing

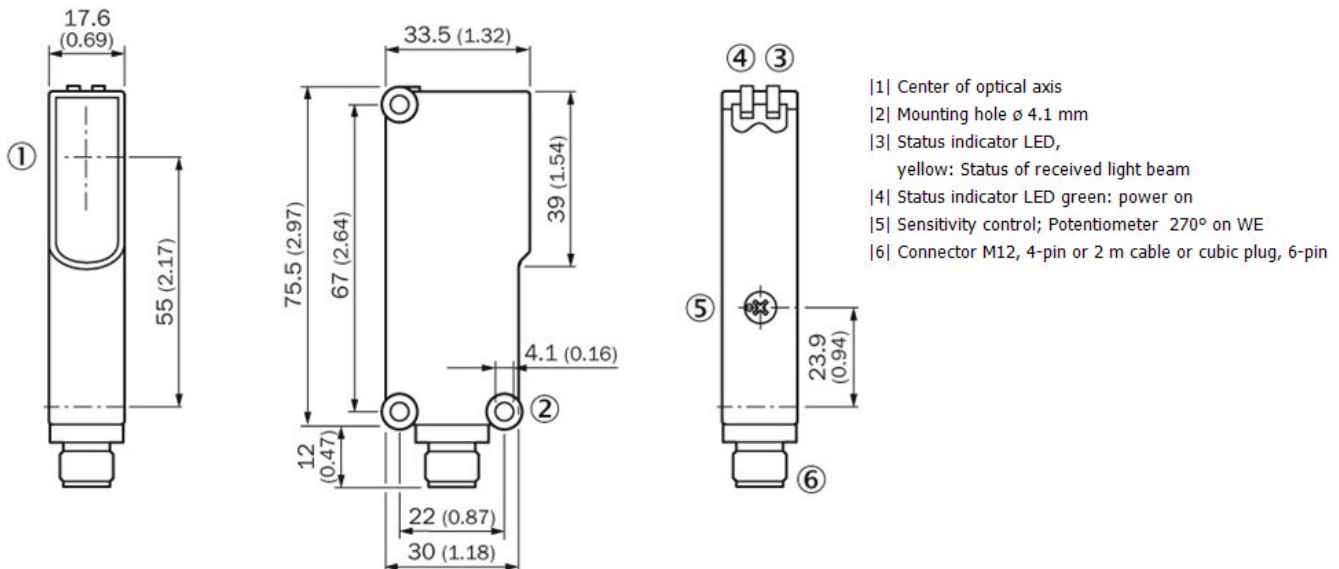

Adjustments possible

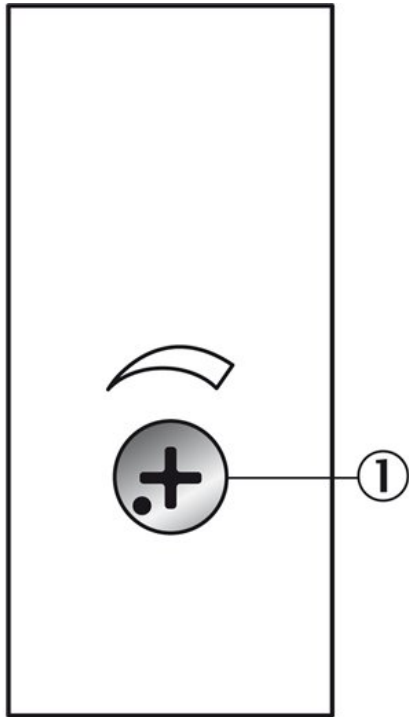

[1] Sensing range adjustment: potentiometer, 4-turn

Connection diagram

①

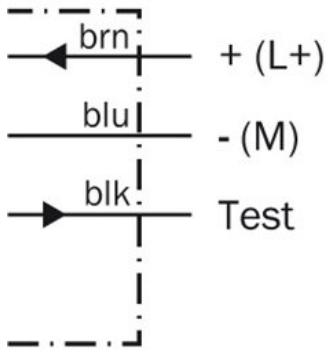

②

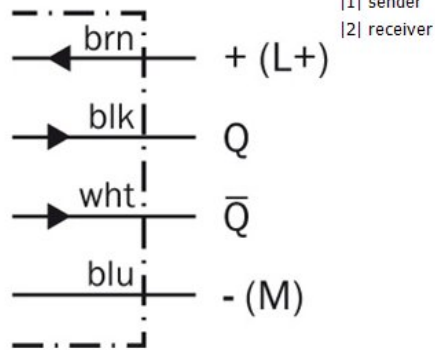

Characteristic curve

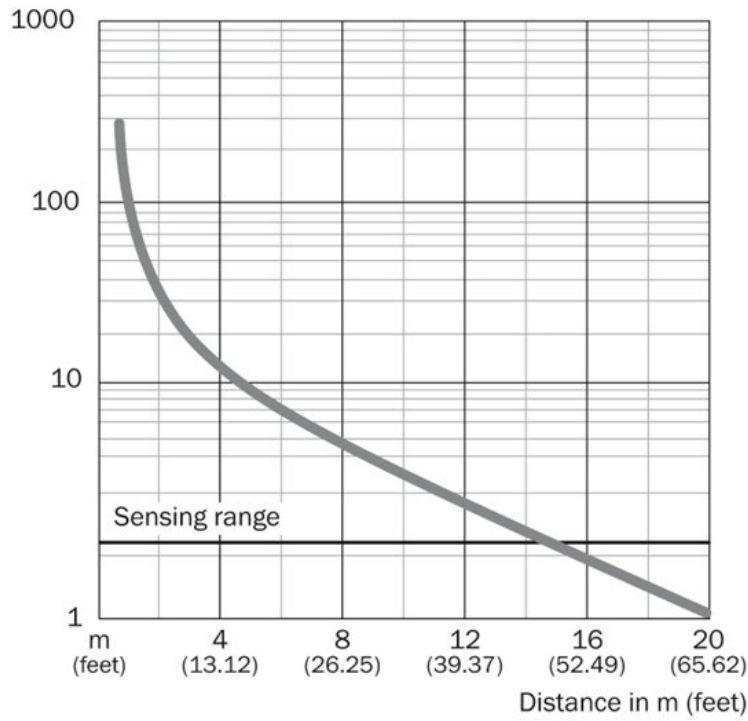

Sensing range diagram

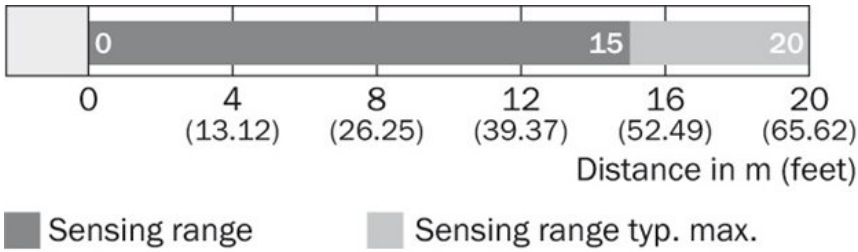

Connection type

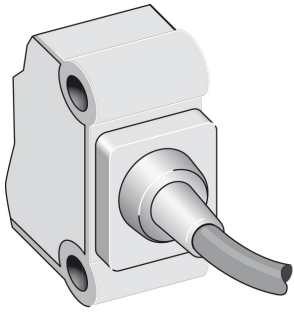

Australia

Phone +61 3 9457 0600
1800 334 802 – tollfree
E-Mail sales@sick.com.au

Belgium/Luxembourg

Phone +32 (0)2 466 55 66
E-Mail info@sick.be

Brasil

Phone +55 11 3215-4900
E-Mail sac@sick.com.br

Canada

Phone +1 905 771 14 44
E-Mail information@sick.com

Ceská Republika

Phone +420 2 57 91 18 50
E-Mail sick@sick.cz

China

Phone +86 4000 121 000
E-Mail info.china@sick.net.cn
Phone +852-2153 6300
E-Mail ghk@sick.com.hk

Danmark

Phone +45 45 82 64 00
E-Mail sick@sick.dk

Deutschland

Phone +49 211 5301-301
E-Mail kundenservice@sick.de

España

Phone +34 93 480 31 00
E-Mail info@sick.es

France

Phone +33 1 64 62 35 00
E-Mail info@sick.fr

Great Britain

Phone +44 (0)1727 831121
E-Mail info@sick.co.uk

India

Phone +91-22-4033 8333
E-Mail info@sick-india.com

Israel

Phone +972-4-6801000
E-Mail info@sick-sensors.com

Italia

Phone +39 02 27 43 41
E-Mail info@sick.it

Japan

Phone +81 (0)3 3358 1341
E-Mail support@sick.jp

Magyarország

Phone +36 1 371 2680
E-Mail office@sick.hu

Nederlands

Phone +31 (0)30 229 25 44
E-Mail info@sick.nl

Norge

Phone +47 67 81 50 00
E-Mail austefjord@sick.no

Österreich

Phone +43 (0)22 36 62 28 8-0
E-Mail office@sick.at

Polska

Phone +48 22 837 40 50
E-Mail info@sick.pl

România

Phone +40 356 171 120
E-Mail office@sick.ro

Russia

Phone +7-495-775-05-30
E-Mail info@sick.ru

Schweiz

Phone +41 41 619 29 39
E-Mail contact@sick.ch

Singapore

Phone +65 6744 3732
E-Mail admin@sicksgp.com.sg

Slovenija

Phone +386 (0)1-47 69 990
E-Mail office@sick.si

South Africa

Phone +27 11 472 3733
E-Mail info@sickautomation.co.za

South Korea

Phone +82 2 786 6321/4
E-Mail info@sickkorea.net

Suomi

Phone +358-9-25 15 800
E-Mail sick@sick.fi

Sverige

Phone +46 10 110 10 00
E-Mail info@sick.se

Taiwan

Phone +886-2-2375-6288
E-Mail sales@sick.com.tw

Türkiye

Phone +90 (216) 528 50 00
E-Mail info@sick.com.tr

United Arab Emirates

Phone +971 (0) 4 8865 878
E-Mail info@sick.ae

USA/México

Phone +1(952) 941-6780
1 800-325-7425 – tollfree
E-Mail info@sickusa.com

More representatives and agencies
at www.sick.com