



Photoelectric sensors  
W12-2 Laser, Through-beam photoelectric sensor

WS/WE12L-2N430A01



**Model Name** > [WS/WE12L-2N430A01](#)  
**Part No.** > [1018478](#)



*Illustration may differ*

**At a glance**

- Laser protection class 1 or 2
- Large sensing range and high levels of operating reserve
- Rugged sensors for industrial use
- Highly visible laser light spot for varying object detection
- Rugged die-cast zinc housing with optional Teflon® coating
- Versatile mounting options due to dovetail mounting - mounting holes and oblong holes
- Highly visible status LEDs
- Adjustable sensing range

**Your benefits**

High immunity to optical interference provides reliable object detection, large sensing ranges and high reserve levels

Highly visible laser light spot enables quick sensor alignment, excellent switching characteristics and high-quality detection

Rugged metal housing (optional Teflon® coating available) requires less maintenance due to its resistance to high-pressure cleaning environments

Highly visible status LEDs simplify commissioning and reduce installation time

Laser protection class 1 or 2 for eye safety

Easy installation using SICK accessories



**Features**

Sensor/detection principle:	Through-beam photoelectric sensor
Dimensions (W x H x D):	15 mm x 49 mm x 41.5 mm
Housing design (light emission):	Rectangular
Sensing range max.:	0 m ... 80 m
Type of light:	Visible red light
Light source:	Laser <sup>1)</sup>
Laser class:	II
Wave length:	650 nm
Light spot size (distance):	Ø 150 mm (60 m)

<sup>1)</sup> Average service life 50,000 h at T<sub>A</sub> = +25 °C

## Mechanics/electronics

---

Supply voltage:	10 V DC ... 30 V DC <sup>1)</sup>
Ripple:	$\leq 5$ Vpp <sup>2)</sup>
Power consumption, sender:	$\leq 45$ mA <sup>3)</sup>
Power consumption, receiver:	$\leq 15$ mA <sup>4)</sup>
Output type:	NPN
Signal voltage PNP HIGH/LOW:	$U_v - < 2.9$ V, $U_v$ V/0 V $\leq 1.5$ V
Signal voltage NPN HIGH/LOW:	$U_v - < 2.9$ V, $U_v$ V/0 V $\leq 1.5$ V
Output current I <sub>max.</sub> :	100 mA
Response time:	$\leq 200$ $\mu$ s <sup>5)</sup>
Switching frequency:	2,500 Hz <sup>6)</sup>
Connection type:	Connector M12, 4-pin
Circuit protection:::	A, C, D <sup>7) 8) 9)</sup>
Protection class:	II
Weight:	260 g
Housing material:	Metal
Enclosure rating:	IP 67 IP 69K
Special features:	American version
Ambient operating temperature:	-10 °C ... 50 °C
Ambient storage temperature:	-25 °C ... 75 °C

<sup>1)</sup> Limit values <sup>2)</sup> May not exceed or fall short of  $V_S$  tolerances <sup>3) 4)</sup> Without load <sup>5)</sup> Signal transit time with resistive load <sup>6)</sup> With light/dark ratio 1:1 <sup>7)</sup>  $A = V_S$   
<sup>8)</sup> C = interference suppression <sup>9)</sup> D = outputs overcurrent and short-circuit protected

## Dimensional drawing

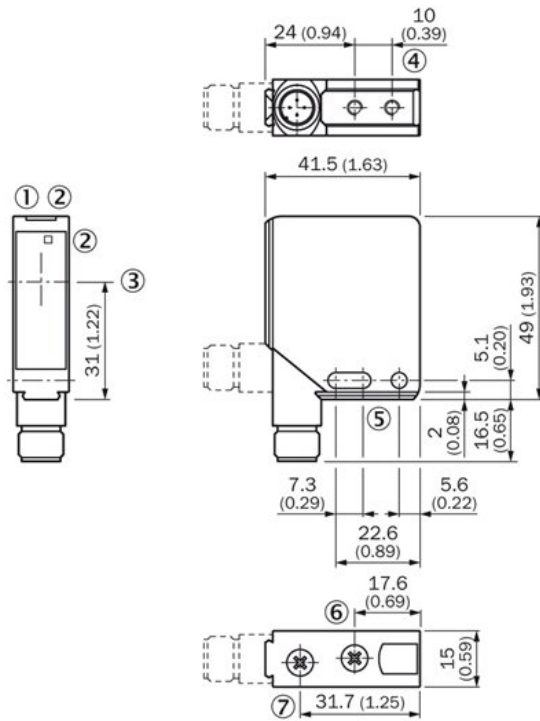

- |1| Operating indicator, green
- |2| LED reception indicator, yellow
- |3| Center of optical axis
- |5| Mounting hole,  $\varnothing$  4.2 mm
- |6| Focal adjustment
- |7| Sensitivity adjustment

## Adjustments possible

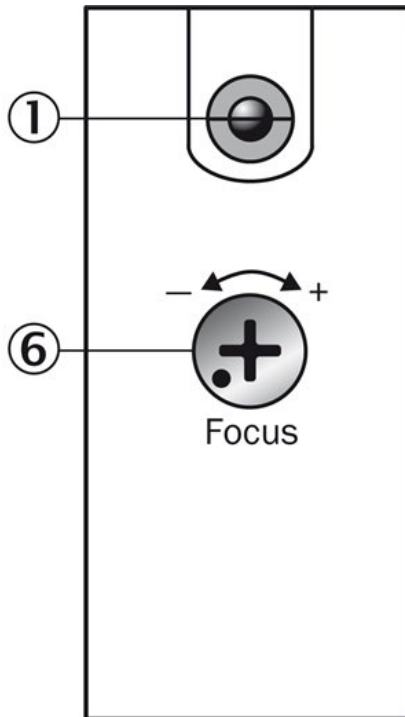

- |1| Operating indicator (WS above only)
- |6| Focal adjustment (WS)

Connection diagram

①

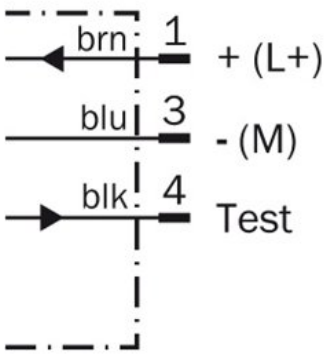

②

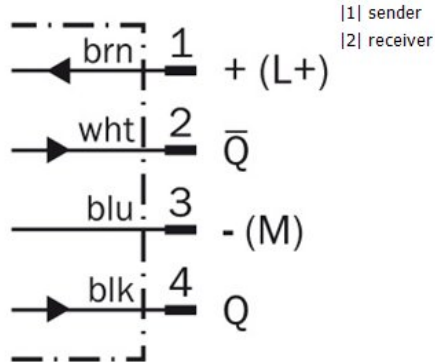

Characteristic curve

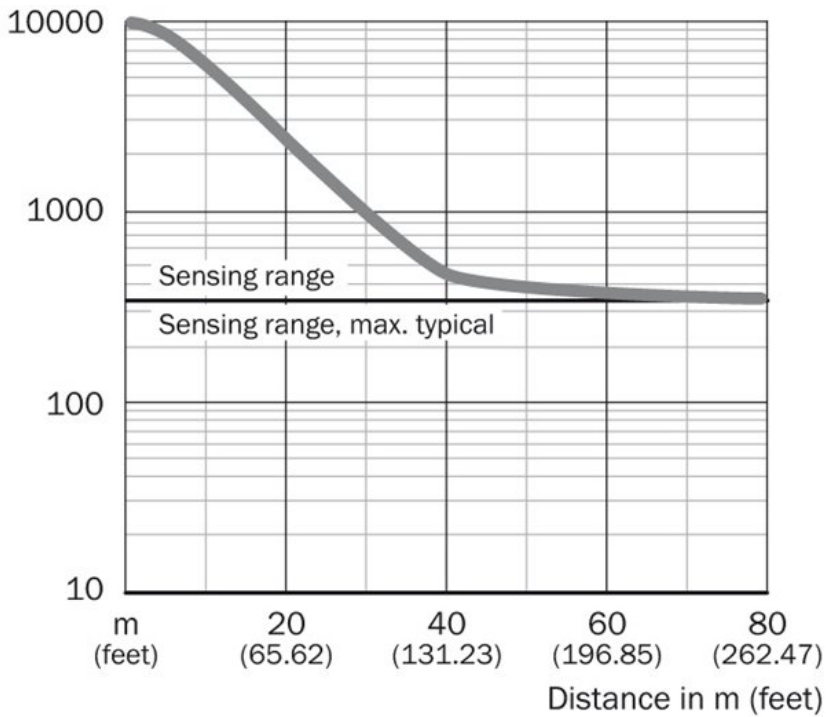

**Sensing range diagram**

---

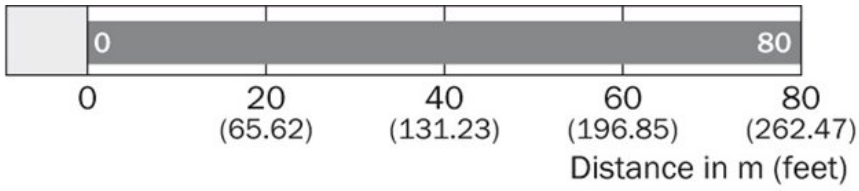

■ Sensing range/sensing range typ. max.

**Connection type**

---

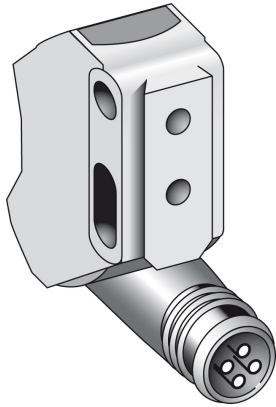

**Australia**

Phone +61 3 9457 0600  
1800 334 802 – tollfree  
E-Mail sales@sick.com.au

**Belgium/Luxembourg**

Phone +32 (0)2 466 55 66  
E-Mail info@sick.be

**Brasil**

Phone +55 11 3215-4900  
E-Mail sac@sick.com.br

**Canada**

Phone +1 905 771 14 44  
E-Mail information@sick.com

**Ceská Republika**

Phone +420 2 57 91 18 50  
E-Mail sick@sick.cz

**China**

Phone +86 4000 121 000  
E-Mail info.china@sick.net.cn  
Phone +852-2153 6300  
E-Mail ghk@sick.com.hk

**Danmark**

Phone +45 45 82 64 00  
E-Mail sick@sick.dk

**Deutschland**

Phone +49 211 5301-301  
E-Mail kundenservice@sick.de

**España**

Phone +34 93 480 31 00  
E-Mail info@sick.es

**France**

Phone +33 1 64 62 35 00  
E-Mail info@sick.fr

**Great Britain**

Phone +44 (0)1727 831121  
E-Mail info@sick.co.uk

**India**

Phone +91-22-4033 8333  
E-Mail info@sick-india.com

**Israel**

Phone +972-4-6801000  
E-Mail info@sick-sensors.com

**Italia**

Phone +39 02 27 43 41  
E-Mail info@sick.it

**Japan**

Phone +81 (0)3 3358 1341  
E-Mail support@sick.jp

**Magyarország**

Phone +36 1 371 2680  
E-Mail office@sick.hu

**Nederlands**

Phone +31 (0)30 229 25 44  
E-Mail info@sick.nl

**Norge**

Phone +47 67 81 50 00  
E-Mail austefjord@sick.no

**Österreich**

Phone +43 (0)22 36 62 28 8-0  
E-Mail office@sick.at

**Polska**

Phone +48 22 837 40 50  
E-Mail info@sick.pl

**România**

Phone +40 356 171 120  
E-Mail office@sick.ro

**Russia**

Phone +7-495-775-05-30  
E-Mail info@sick.ru

**Schweiz**

Phone +41 41 619 29 39  
E-Mail contact@sick.ch

**Singapore**

Phone +65 6744 3732  
E-Mail admin@sicksgp.com.sg

**Slovenija**

Phone +386 (0)1-47 69 990  
E-Mail office@sick.si

**South Africa**

Phone +27 11 472 3733  
E-Mail info@sickautomation.co.za

**South Korea**

Phone +82 2 786 6321/4  
E-Mail info@sickkorea.net

**Suomi**

Phone +358-9-25 15 800  
E-Mail sick@sick.fi

**Sverige**

Phone +46 10 110 10 00  
E-Mail info@sick.se

**Taiwan**

Phone +886-2-2375-6288  
E-Mail sales@sick.com.tw

**Türkiye**

Phone +90 (216) 528 50 00  
E-Mail info@sick.com.tr

**United Arab Emirates**

Phone +971 (0) 4 8865 878  
E-Mail info@sick.ae

**USA/México**

Phone +1(952) 941-6780  
1 800-325-7425 – tollfree  
E-Mail info@sickusa.com

More representatives and agencies  
at [www.sick.com](http://www.sick.com)