



Photoelectric sensors
W12-2 Laser, Through-beam photoelectric sensor

WS/WE12L-2P410A03



Model Name > [WS/WE12L-2P410A03](#)
Part No. > [1023059](#)



Illustration may differ

At a glance

- Laser protection class 1 or 2
- Large sensing range and high levels of operating reserve
- Rugged sensors for industrial use
- Highly visible laser light spot for varying object detection
- Rugged die-cast zinc housing with optional Teflon® coating
- Versatile mounting options due to dovetail mounting - mounting holes and oblong holes
- Highly visible status LEDs
- Adjustable sensing range

Your benefits

High immunity to optical interference provides reliable object detection, large sensing ranges and high reserve levels

Highly visible laser light spot enables quick sensor alignment, excellent switching characteristics and high-quality detection

Rugged metal housing (optional Teflon® coating available) requires less maintenance due to its resistance to high-pressure cleaning environments

Highly visible status LEDs simplify commissioning and reduce installation time

Laser protection class 1 or 2 for eye safety

Easy installation using SICK accessories



Features

Sensor/detection principle:	Through-beam photoelectric sensor
Dimensions (W x H x D):	15 mm x 49 mm x 41.5 mm
Housing design (light emission):	Rectangular
Sensing range max.:	0 m ... 80 m
Type of light:	Visible red light
Light source:	Laser ¹⁾
Laser class:	II
Wave length:	650 nm
Light spot size (distance):	Ø 1 mm (2 m)

¹⁾ Average service life 50,000 h at T_A = +25 °C

Mechanics/electronics

Supply voltage:	10 V DC ... 30 V DC ¹⁾
Ripple:	$\leq 5 \text{ Vpp}$ ²⁾
Power consumption, sender:	$\leq 45 \text{ mA}$ ³⁾
Power consumption, receiver:	$\leq 15 \text{ mA}$ ⁴⁾
Output type:	PNP
Signal voltage PNP HIGH/LOW:	$U_v - < 2.9 \text{ V}, U_v \text{ V}/0 \text{ V} \leq 1.5 \text{ V}$
Signal voltage NPN HIGH/LOW:	$U_v - < 2.9 \text{ V}, U_v \text{ V}/0 \text{ V} \leq 1.5 \text{ V}$
Output current I _{max.} :	100 mA
Response time:	$\leq 200 \mu\text{s}$ ⁵⁾
Switching frequency:	2,500 Hz ⁶⁾
Connection type:	Connector M12, 4-pin
Circuit protection:::	A, C, D ^{7) 8) 9)}
Protection class:	II
Weight:	260 g
Housing material:	Metal
Enclosure rating:	IP 67 IP 69K
Special features:	American version
Ambient operating temperature:	-10 °C ... 50 °C
Ambient storage temperature:	-25 °C ... 75 °C
Part number of individual components:	Receiver, WE12L-2P430, 2021726, Sender, WS12L-2D410A03, 2026587

¹⁾ Limit values ²⁾ May not exceed or fall short of V_S tolerances ^{3) 4)} Without load ⁵⁾ Signal transit time with resistive load ⁶⁾ With light/dark ratio 1:1 ⁷⁾ $A = V_S$
⁸⁾ C = interference suppression ⁹⁾ D = outputs overcurrent and short-circuit protected

Dimensional drawing

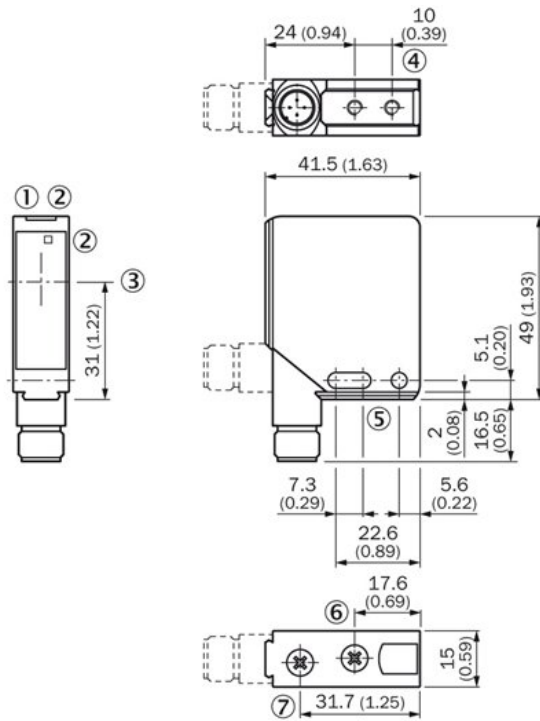

- |1| Operating indicator, green
- |2| LED reception indicator, yellow
- |3| Center of optical axis
- |5| Mounting hole, \varnothing 4.2 mm
- |6| Focal adjustment
- |7| Sensitivity adjustment

Adjustments possible

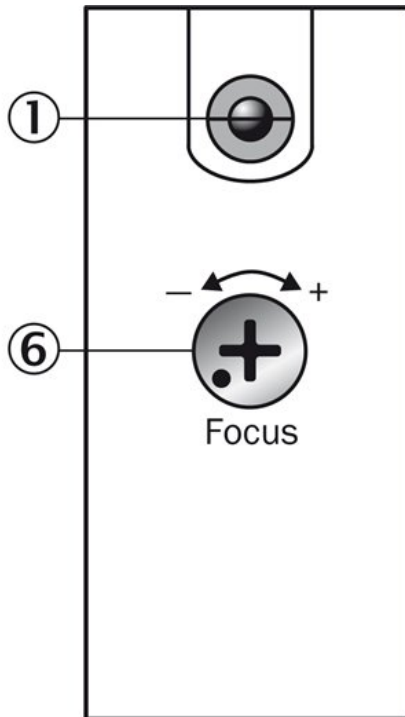

- |1| Operating indicator (WS above only)
- |6| Focal adjustment (WS)

Connection diagram

①

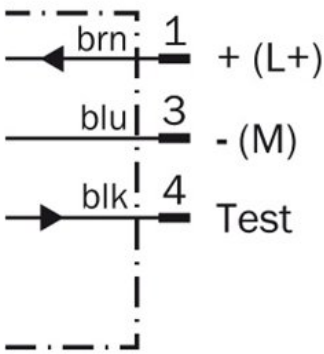

②

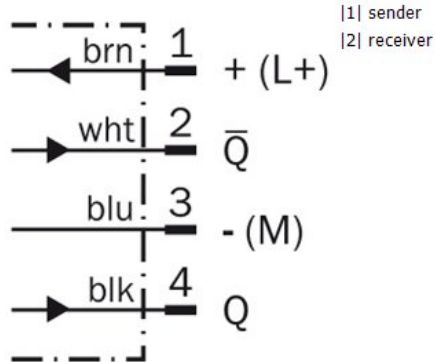

Characteristic curve

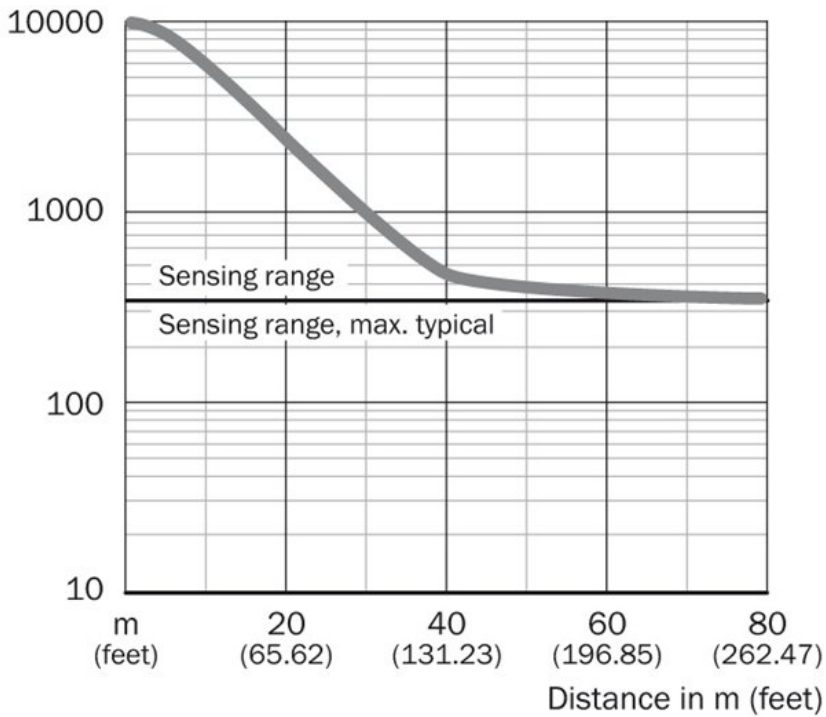

Sensing range diagram

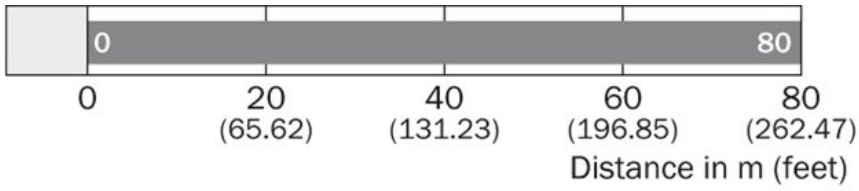

■ Sensing range/sensing range typ. max.

Connection type

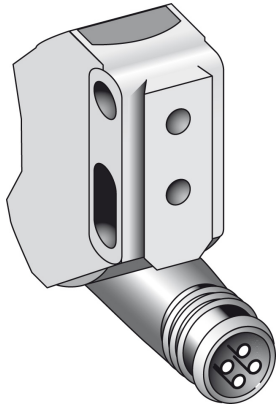

Australia

Phone +61 3 9457 0600
1800 334 802 – tollfree
E-Mail sales@sick.com.au

Belgium/Luxembourg

Phone +32 (0)2 466 55 66
E-Mail info@sick.be

Brasil

Phone +55 11 3215-4900
E-Mail sac@sick.com.br

Canada

Phone +1 905 771 14 44
E-Mail information@sick.com

Ceská Republika

Phone +420 2 57 91 18 50
E-Mail sick@sick.cz

China

Phone +86 4000 121 000
E-Mail info.china@sick.net.cn
Phone +852-2153 6300
E-Mail ghk@sick.com.hk

Danmark

Phone +45 45 82 64 00
E-Mail sick@sick.dk

Deutschland

Phone +49 211 5301-301
E-Mail kundenservice@sick.de

España

Phone +34 93 480 31 00
E-Mail info@sick.es

France

Phone +33 1 64 62 35 00
E-Mail info@sick.fr

Great Britain

Phone +44 (0)1727 831121
E-Mail info@sick.co.uk

India

Phone +91-22-4033 8333
E-Mail info@sick-india.com

Israel

Phone +972-4-6801000
E-Mail info@sick-sensors.com

Italia

Phone +39 02 27 43 41
E-Mail info@sick.it

Japan

Phone +81 (0)3 3358 1341
E-Mail support@sick.jp

Magyarország

Phone +36 1 371 2680
E-Mail office@sick.hu

Nederlands

Phone +31 (0)30 229 25 44
E-Mail info@sick.nl

Norge

Phone +47 67 81 50 00
E-Mail austefjord@sick.no

Österreich

Phone +43 (0)22 36 62 28 8-0
E-Mail office@sick.at

Polska

Phone +48 22 837 40 50
E-Mail info@sick.pl

România

Phone +40 356 171 120
E-Mail office@sick.ro

Russia

Phone +7-495-775-05-30
E-Mail info@sick.ru

Schweiz

Phone +41 41 619 29 39
E-Mail contact@sick.ch

Singapore

Phone +65 6744 3732
E-Mail admin@sicksgp.com.sg

Slovenija

Phone +386 (0)1-47 69 990
E-Mail office@sick.si

South Africa

Phone +27 11 472 3733
E-Mail info@sickautomation.co.za

South Korea

Phone +82 2 786 6321/4
E-Mail info@sickkorea.net

Suomi

Phone +358-9-25 15 800
E-Mail sick@sick.fi

Sverige

Phone +46 10 110 10 00
E-Mail info@sick.se

Taiwan

Phone +886-2-2375-6288
E-Mail sales@sick.com.tw

Türkiye

Phone +90 (216) 528 50 00
E-Mail info@sick.com.tr

United Arab Emirates

Phone +971 (0) 4 8865 878
E-Mail info@sick.ae

USA/México

Phone +1(952) 941-6780
1 800-325-7425 – tollfree
E-Mail info@sickusa.com

More representatives and agencies
at www.sick.com