



Photoelectric sensors  
W100, Through-beam photoelectric sensor

WS/WE100-N1409



**Model Name** > [WS/WE100-N1409](#)  
**Part No.** > [6036513](#)



*Illustration may differ*

**At a glance**

- Standard miniature housing with M3 threaded mounting holes
- Optics with standard red LED or bright light LED
- Special slotted masks and polarizing filter tip adapters available as accessories
- Light/dark switching and sensitivity adjustment via rotary switch possible

**Your benefits**

- Highly visible light spot simplifies alignment
- Less contamination due to high optical operating reserve
- M3 threaded mounting holes provide easy installation
- Special accessory allows optimizing the optical performance depending on the application



**Features**

Sensor/detection principle:	Through-beam photoelectric sensor
Dimensions (W x H x D):	11 mm x 31 mm x 20 mm
Housing design (light emission):	Rectangular, Slim
Sensing range max.:	0 m ... 30 m
Sensing range:	0 m ... 20 m
Type of light:	Visible red light
Light source:	BrightLight LED <sup>1)</sup>
Wave length:	645 nm
Sensitivity adjustment:	Potentiometer, 270°
Angle of dispersion:	Ca. 2 °
Focus adjustable:	-
Light spot size (distance):	Ø 800 mm (20 m)

<sup>1)</sup> Average service life of 100,000 h at T<sub>A</sub> = +25 °C

**Mechanics/electronics**

Supply voltage:	10 V DC ... 30 V DC <sup>1)</sup>
Ripple:	± 10 % <sup>2)</sup>
Power consumption, sender:	≤ 15 mA <sup>3)</sup>
Power consumption, receiver:	≤ 20 mA <sup>4)</sup>
Output type:	NPN
Switching mode:	Light/dark-switching
Output characteristic:	Open collector

Switching mode selector:	Manually selectable
Signal voltage NPN HIGH/LOW:	Approx. $V_S / < 1.8 \text{ V}$
Output current $I_{max}$ :	100
Response time:	$\leq 0.5 \text{ ms}$ <sup>5)</sup>
Switching frequency:	1,000 <sup>6)</sup>
Angle of reception:	Ca. $15^\circ$
Connection type:	Cable, 3-wire, 2 m <sup>7)</sup>
Cable material:	PVC
Conductor cross-section:	$0.18 \text{ mm}^2$
Circuit protection:::	A, B, D <sup>8) 9) 10)</sup>
Weight:	106 g
Polarisation filter:	-
Housing material:	ABS/PC/POM, Plastic
Optics material:	PMMA
Enclosure rating:	IP 67
Items supplied:	2 Stainless steel mounting brackets (1.4301/304) BEF-W100-A
Ambient operating temperature:	$-25^\circ \text{C} \dots 55^\circ \text{C}$
Ambient storage temperature:	$-40^\circ \text{C} \dots 70^\circ \text{C}$

1) Limit values, operation in short-circuit protected network max. 8 A <sup>2)</sup> May not exceed or fall short of  $V_S$  tolerances <sup>3) 4)</sup> Without load <sup>5)</sup> Signal transit time with resistive load <sup>6)</sup> With light/dark ratio 1:1 <sup>7)</sup> Do not bend below  $0^\circ \text{C}$  <sup>8)</sup> A =  $V_S$  connections reverse-polarity protected <sup>9)</sup> B = inputs and output reverse-polarity protected <sup>10)</sup> D = outputs overcurrent and short-circuit protected

## Dimensional drawing

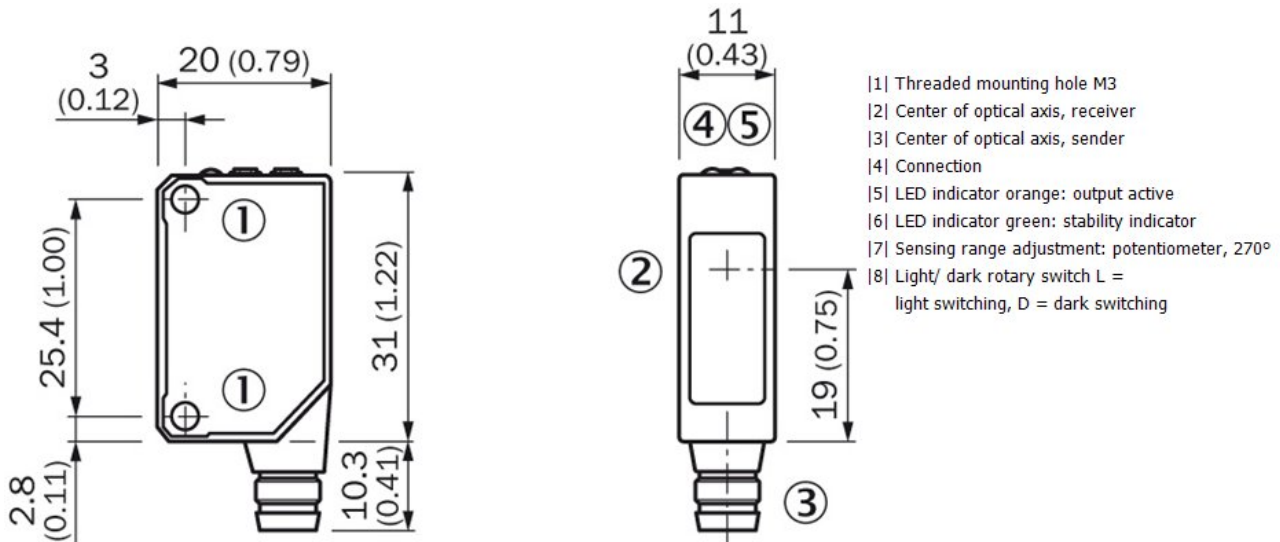

## Adjustments possible

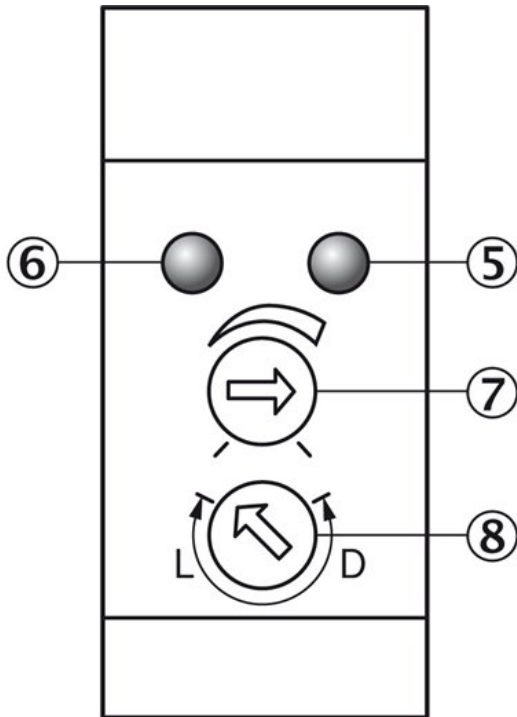

- [5] LED indicator orange: switching output active
- [6] LED indicator green- power on
- [7] Sensing range adjustment: potentiometer, 270°
- [8] Light/ dark rotary switch L = light switching, D = dark switching

## Connection diagram

①

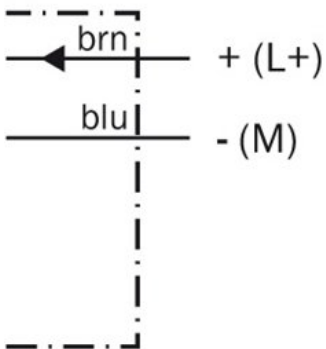

②

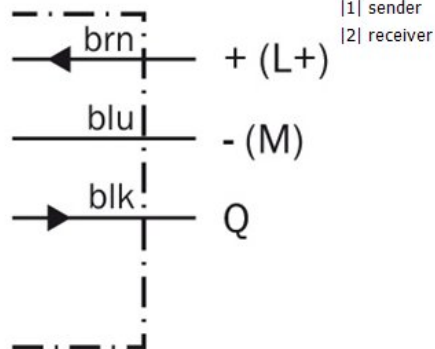

### Characteristic curve

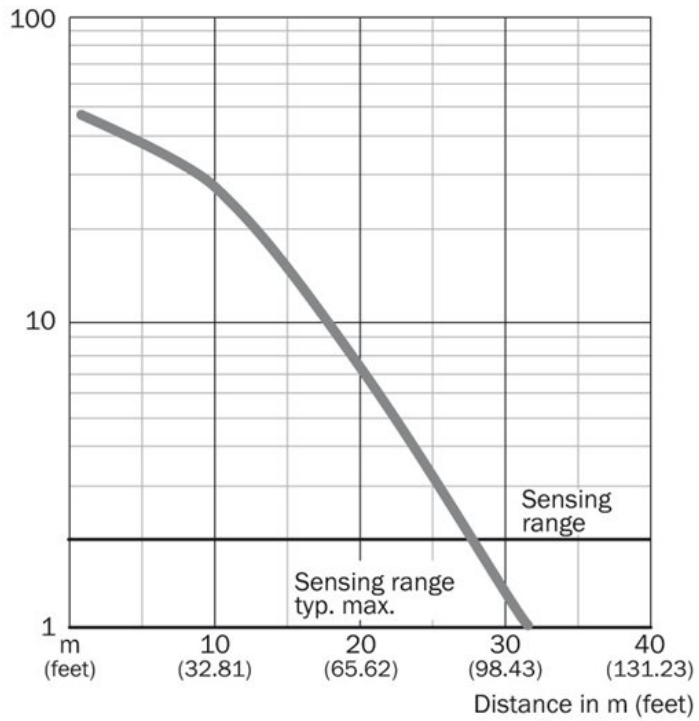

### Sensing range diagram

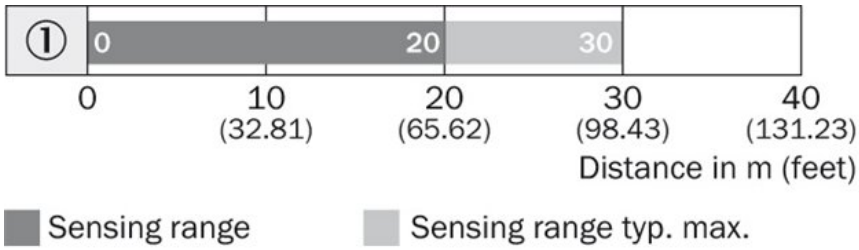

Connection type

---

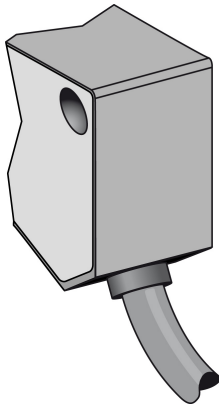

**Australia**

Phone +61 3 9457 0600  
1800 334 802 – tollfree  
E-Mail sales@sick.com.au

**Belgium/Luxembourg**

Phone +32 (0)2 466 55 66  
E-Mail info@sick.be

**Brasil**

Phone +55 11 3215-4900  
E-Mail sac@sick.com.br

**Canada**

Phone +1 905 771 14 44  
E-Mail information@sick.com

**Ceská Republika**

Phone +420 2 57 91 18 50  
E-Mail sick@sick.cz

**China**

Phone +86 4000 121 000  
E-Mail info.china@sick.net.cn  
Phone +852-2153 6300  
E-Mail ghk@sick.com.hk

**Danmark**

Phone +45 45 82 64 00  
E-Mail sick@sick.dk

**Deutschland**

Phone +49 211 5301-301  
E-Mail kundenservice@sick.de

**España**

Phone +34 93 480 31 00  
E-Mail info@sick.es

**France**

Phone +33 1 64 62 35 00  
E-Mail info@sick.fr

**Great Britain**

Phone +44 (0)1727 831121  
E-Mail info@sick.co.uk

**India**

Phone +91-22-4033 8333  
E-Mail info@sick-india.com

**Israel**

Phone +972-4-6801000  
E-Mail info@sick-sensors.com

**Italia**

Phone +39 02 27 43 41  
E-Mail info@sick.it

**Japan**

Phone +81 (0)3 3358 1341  
E-Mail support@sick.jp

**Magyarország**

Phone +36 1 371 2680  
E-Mail office@sick.hu

**Nederlands**

Phone +31 (0)30 229 25 44  
E-Mail info@sick.nl

**Norge**

Phone +47 67 81 50 00  
E-Mail austefjord@sick.no

**Österreich**

Phone +43 (0)22 36 62 28 8-0  
E-Mail office@sick.at

**Polska**

Phone +48 22 837 40 50  
E-Mail info@sick.pl

**România**

Phone +40 356 171 120  
E-Mail office@sick.ro

**Russia**

Phone +7-495-775-05-30  
E-Mail info@sick.ru

**Schweiz**

Phone +41 41 619 29 39  
E-Mail contact@sick.ch

**Singapore**

Phone +65 6744 3732  
E-Mail admin@sicksgp.com.sg

**Slovenija**

Phone +386 (0)1-47 69 990  
E-Mail office@sick.si

**South Africa**

Phone +27 11 472 3733  
E-Mail info@sickautomation.co.za

**South Korea**

Phone +82 2 786 6321/4  
E-Mail info@sickkorea.net

**Suomi**

Phone +358-9-25 15 800  
E-Mail sick@sick.fi

**Sverige**

Phone +46 10 110 10 00  
E-Mail info@sick.se

**Taiwan**

Phone +886-2-2375-6288  
E-Mail sales@sick.com.tw

**Türkiye**

Phone +90 (216) 528 50 00  
E-Mail info@sick.com.tr

**United Arab Emirates**

Phone +971 (0) 4 8865 878  
E-Mail info@sick.ae

**USA/México**

Phone +1(952) 941-6780  
1 800-325-7425 – tollfree  
E-Mail info@sickusa.com

More representatives and agencies  
at [www.sick.com](http://www.sick.com)