



Photoelectric sensors
W100, Through-beam photoelectric sensor

WS/WE100-N1239



Model Name > [WS/WE100-N1239](#)
Part No. > [6026038](#)



Illustration may differ

At a glance

- Standard miniature housing with M3 threaded mounting holes
- Optics with standard red LED or bright light LED
- Special slotted masks and polarizing filter tip adapters available as accessories
- Light/dark switching and sensitivity adjustment via rotary switch possible

Your benefits

- Highly visible light spot simplifies alignment
- Less contamination due to high optical operating reserve
- M3 threaded mounting holes provide easy installation
- Special accessory allows optimizing the optical performance depending on the application



Features

| | |
|----------------------------------|-----------------------------------|
| Sensor/detection principle: | Through-beam photoelectric sensor |
| Dimensions (W x H x D): | 11 mm x 31 mm x 20 mm |
| Housing design (light emission): | Rectangular |
| Sensing range max.: | 0 m ... 15 m |
| Sensing range: | 0 m ... 12 m |
| Type of light: | Visible red light |
| Light source: | LED ¹⁾ |
| Wave length: | 680 nm |
| Angle of dispersion: | Ca. 7.2 ° |
| Focus adjustable: | - |
| Light spot size (distance): | Ø 1,500 mm (12 m) |

¹⁾ Average service life of 100,000 h at T_A = +25 °C

Mechanics/electronics

| | |
|------------------------------------|-----------------------------------|
| Supply voltage: | 10 V DC ... 30 V DC ¹⁾ |
| Ripple: | ± 10 % ²⁾ |
| Power consumption, sender: | ≤ 15 mA ³⁾ |
| Power consumption, receiver: | ≤ 20 mA ⁴⁾ |
| Output type: | NPN, open collector |
| Switching mode: | Dark-switching |
| Signal voltage NPN HIGH/LOW: | Approx. VS / < 1.8 V |
| Output current I _{max.} : | 100 |

| | |
|--------------------------------|---|
| Response time: | $\leq 0.5 \text{ ms}$ ⁵⁾ |
| Switching frequency: | 1,000 ⁶⁾ |
| Angle of reception: | Ca. 15 ° |
| Connection type: | Cable, 3-wire, 2 m ⁷⁾ |
| Cable material: | PVC |
| Conductor cross-section: | 0.18 mm ² |
| Circuit protection::: | A, B, D ^{8) 9) 10)} |
| Weight: | 106 g |
| Polarisation filter: | - |
| Housing material: | ABS/PC, Plastic |
| Optics material: | PMMA |
| Enclosure rating: | IP 65 |
| Items supplied: | 2 Stainless steel mounting brackets (1.4301/304) BEF-W100-A |
| Ambient operating temperature: | -25 °C ... 55 °C |
| Ambient storage temperature: | -40 °C ... 70 °C |

¹⁾ Limit values, operation in short-circuit protected network max. 8 A resistive load ⁶⁾ With light/dark ratio 1:1 ⁷⁾ Do not bend below 0 °C
²⁾ May not exceed or fall short of V_S tolerances ^{3) 4)} Without load ⁵⁾ Signal transit time with
⁸⁾ A = V_S connections reverse-polarity protected ⁹⁾ B = inputs and output reverse-polarity protected ¹⁰⁾ D = outputs overcurrent and short-circuit protected

Dimensional drawing

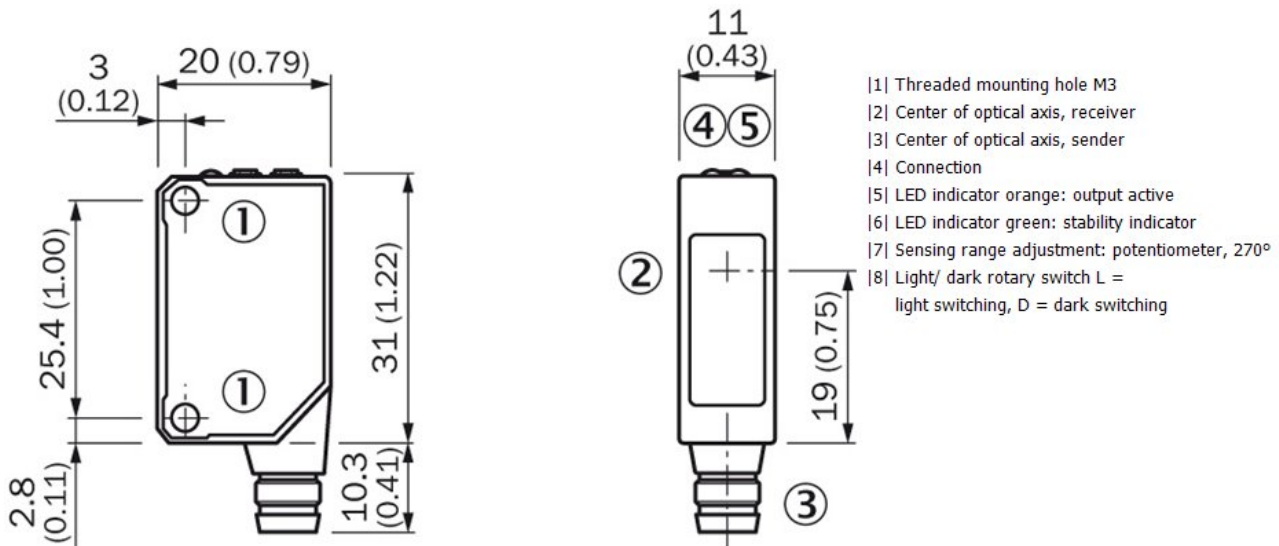

Adjustments possible

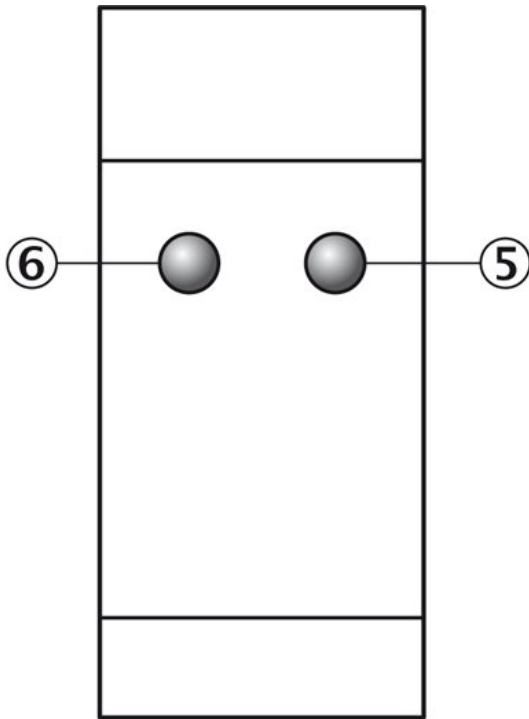

|5| Orange LED indicator : switching output active
|6| LED indicator green: stability indicator

Connection diagram

①

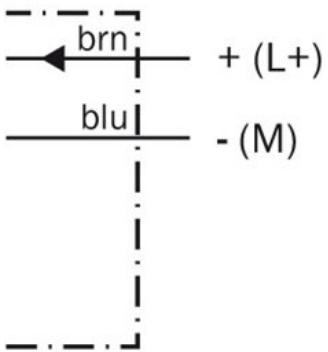

②

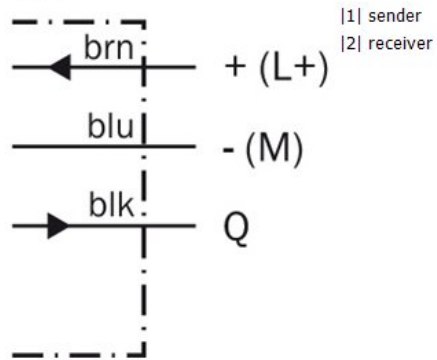

Characteristic curve

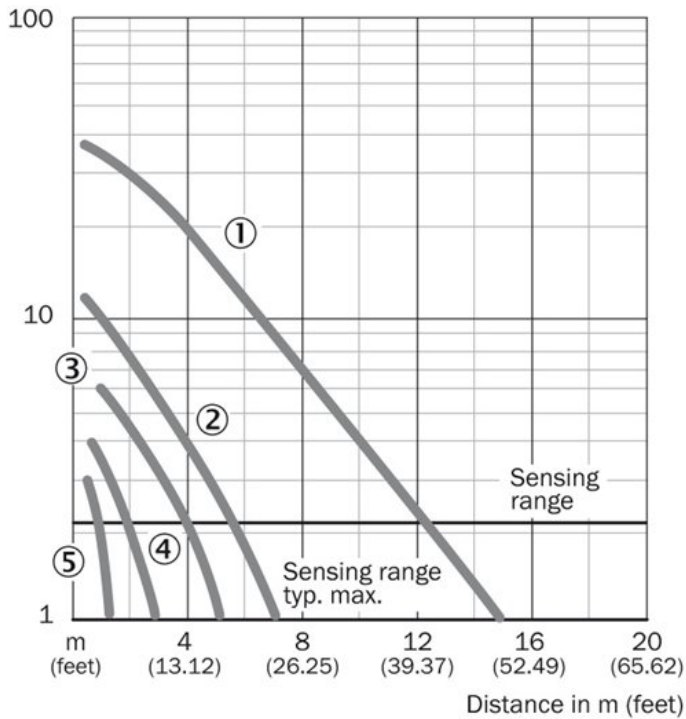

- [1] Without masks
- [2] With polarization filter tip adapter
- [3] With slotted mask, width 2.0 mm
- [4] With slotted mask, width 1.0 mm
- [5] With slotted mask, width 0.5 mm

Sensing range diagram

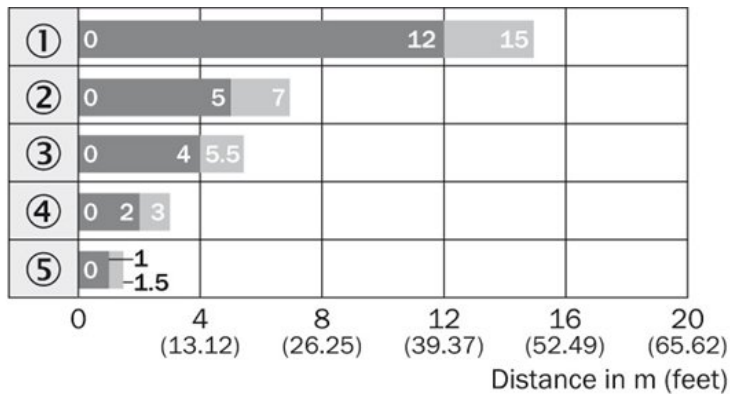

- [1] Without masks
- [2] With polarization filter tip adapter
- [3] With slotted mask, width 2.0 mm
- [4] With slotted mask, width 1.0 mm
- [5] With slotted mask, width 0.5 mm

■ Sensing range ■ Sensing range typ. max.

Sensing range reduction when slotted masks are used

- ① Without masks/polarization filter
- ② With polarization filter tip adapter
- ③ With slotted mask, width 2.0 mm
- ④ With slotted mask, width 1.0 mm
- ⑤ With slotted mask, width 0.5 mm

Connection type

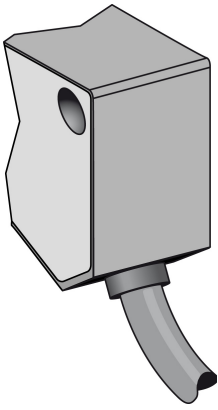

Australia

Phone +61 3 9457 0600
1800 334 802 – tollfree
E-Mail sales@sick.com.au

Belgium/Luxembourg

Phone +32 (0)2 466 55 66
E-Mail info@sick.be

Brasil

Phone +55 11 3215-4900
E-Mail sac@sick.com.br

Canada

Phone +1 905 771 14 44
E-Mail information@sick.com

Ceská Republika

Phone +420 2 57 91 18 50
E-Mail sick@sick.cz

China

Phone +86 4000 121 000
E-Mail info.china@sick.net.cn
Phone +852-2153 6300
E-Mail ghk@sick.com.hk

Danmark

Phone +45 45 82 64 00
E-Mail sick@sick.dk

Deutschland

Phone +49 211 5301-301
E-Mail kundenservice@sick.de

España

Phone +34 93 480 31 00
E-Mail info@sick.es

France

Phone +33 1 64 62 35 00
E-Mail info@sick.fr

Great Britain

Phone +44 (0)1727 831121
E-Mail info@sick.co.uk

India

Phone +91-22-4033 8333
E-Mail info@sick-india.com

Israel

Phone +972-4-6801000
E-Mail info@sick-sensors.com

Italia

Phone +39 02 27 43 41
E-Mail info@sick.it

Japan

Phone +81 (0)3 3358 1341
E-Mail support@sick.jp

Magyarország

Phone +36 1 371 2680
E-Mail office@sick.hu

Nederlands

Phone +31 (0)30 229 25 44
E-Mail info@sick.nl

Norge

Phone +47 67 81 50 00
E-Mail austefjord@sick.no

Österreich

Phone +43 (0)22 36 62 28 8-0
E-Mail office@sick.at

Polska

Phone +48 22 837 40 50
E-Mail info@sick.pl

România

Phone +40 356 171 120
E-Mail office@sick.ro

Russia

Phone +7-495-775-05-30
E-Mail info@sick.ru

Schweiz

Phone +41 41 619 29 39
E-Mail contact@sick.ch

Singapore

Phone +65 6744 3732
E-Mail admin@sicksgp.com.sg

Slovenija

Phone +386 (0)1-47 69 990
E-Mail office@sick.si

South Africa

Phone +27 11 472 3733
E-Mail info@sickautomation.co.za

South Korea

Phone +82 2 786 6321/4
E-Mail info@sickkorea.net

Suomi

Phone +358-9-25 15 800
E-Mail sick@sick.fi

Sverige

Phone +46 10 110 10 00
E-Mail info@sick.se

Taiwan

Phone +886-2-2375-6288
E-Mail sales@sick.com.tw

Türkiye

Phone +90 (216) 528 50 00
E-Mail info@sick.com.tr

United Arab Emirates

Phone +971 (0) 4 8865 878
E-Mail info@sick.ae

USA/México

Phone +1(952) 941-6780
1 800-325-7425 – tollfree
E-Mail info@sickusa.com

More representatives and agencies
at www.sick.com