



## Documentation

# KL3404, KL3408, KL3464 und KL3468

four and eight channel analog input terminals

Version: 3.0.0  
Date: 2017-10-04

**BECKHOFF**



# Table of contents

<b>1 Foreword .....</b>	<b>5</b>
1.1 Notes on the documentation .....	5
1.2 Safety instructions .....	6
1.3 Documentation Issue Status .....	7
<b>2 KL3404-KL3464 –Product overview .....</b>	<b>8</b>
2.1 Introduction .....	8
2.2 Technical data .....	9
2.3 Diagnostic LEDs .....	10
<b>3 KL3408, KL3468 - Product overview .....</b>	<b>11</b>
3.1 Introduction .....	11
3.2 Technical data .....	12
3.3 Diagnostic LEDs .....	13
<b>4 Basic Function Principles.....</b>	<b>14</b>
4.1 KL3404 and KL3408 - Basic Function Principles.....	14
4.2 KL3464 and KL3468 - Basic Function Principles.....	15
<b>5 Mounting and wiring .....</b>	<b>17</b>
5.1 Installation on mounting rails .....	17
5.2 Installation instructions for enhanced mechanical load capacity .....	19
5.3 Connection.....	20
5.3.1 Connection system.....	20
5.3.2 Wiring .....	22
5.3.3 Shielding .....	23
5.3.4 KL3404, KL3464 - connection.....	23
5.3.5 KL3408, KL3468 - connection.....	24
5.4 ATEX - Special conditions (standard temperature range) .....	25
5.5 ATEX - Special conditions (extended temperature range) .....	26
5.6 ATEX Documentation .....	27
<b>6 KS2000 Configuration Software .....</b>	<b>28</b>
6.1 KS2000 - Introduction .....	28
6.2 Parameterization with KS2000 .....	30
6.3 Settings .....	31
6.4 Register .....	33
<b>7 Access from the user program .....</b>	<b>34</b>
7.1 Process image .....	34
7.2 Mapping .....	35
7.3 Control and Status Bytes .....	37
7.4 Register Overview .....	39
7.5 Register description .....	40
7.6 Examples of Register Communication.....	45
7.6.1 Example 1: reading the firmware version from Register 9 .....	45
7.6.2 Example 2: Writing to an user register .....	45
<b>8 Appendix .....</b>	<b>48</b>
8.1 Support and Service .....	48



# 1 Foreword

## 1.1 Notes on the documentation

### Intended audience

This description is only intended for the use of trained specialists in control and automation engineering who are familiar with the applicable national standards.

It is essential that the documentation and the following notes and explanations are followed when installing and commissioning these components.

It is the duty of the technical personnel to use the documentation published at the respective time of each installation and commissioning.

The responsible staff must ensure that the application or use of the products described satisfy all the requirements for safety, including all the relevant laws, regulations, guidelines and standards.

### Disclaimer

The documentation has been prepared with care. The products described are, however, constantly under development.

We reserve the right to revise and change the documentation at any time and without prior announcement.

No claims for the modification of products that have already been supplied may be made on the basis of the data, diagrams and descriptions in this documentation.

### Trademarks

Beckhoff®, TwinCAT®, EtherCAT®, Safety over EtherCAT®, TwinSAFE®, XFC® and XTS® are registered trademarks of and licensed by Beckhoff Automation GmbH.

Other designations used in this publication may be trademarks whose use by third parties for their own purposes could violate the rights of the owners.

### Patent Pending

The EtherCAT Technology is covered, including but not limited to the following patent applications and patents: EP1590927, EP1789857, DE102004044764, DE102007017835 with corresponding applications or registrations in various other countries.

The TwinCAT Technology is covered, including but not limited to the following patent applications and patents: EP0851348, US6167425 with corresponding applications or registrations in various other countries.



EtherCAT® is registered trademark and patented technology, licensed by Beckhoff Automation GmbH, Germany

### Copyright

© Beckhoff Automation GmbH & Co. KG, Germany.

The reproduction, distribution and utilization of this document as well as the communication of its contents to others without express authorization are prohibited.

Offenders will be held liable for the payment of damages. All rights reserved in the event of the grant of a patent, utility model or design.

## 1.2 Safety instructions

### Safety regulations

Please note the following safety instructions and explanations!  
Product-specific safety instructions can be found on following pages or in the areas mounting, wiring, commissioning etc.

### Exclusion of liability





All the components are supplied in particular hardware and software configurations appropriate for the application. Modifications to hardware or software configurations other than those described in the documentation are not permitted, and nullify the liability of Beckhoff Automation GmbH & Co. KG.

### Personnel qualification

This description is only intended for trained specialists in control, automation and drive engineering who are familiar with the applicable national standards.

### Description of symbols

In this documentation the following symbols are used with an accompanying safety instruction or note. The safety instructions must be read carefully and followed without fail!

 <b>DANGER</b>	<p><b>Serious risk of injury!</b> Failure to follow the safety instructions associated with this symbol directly endangers the life and health of persons.</p>
 <b>WARNING</b>	<p><b>Risk of injury!</b> Failure to follow the safety instructions associated with this symbol endangers the life and health of persons.</p>
 <b>CAUTION</b>	<p><b>Personal injuries!</b> Failure to follow the safety instructions associated with this symbol can lead to injuries to persons.</p>
 <b>Attention</b>	<p><b>Damage to the environment or devices</b> Failure to follow the instructions associated with this symbol can lead to damage to the environment or equipment.</p>
 <b>Note</b>	<p><b>Tip or pointer</b> This symbol indicates information that contributes to better understanding.</p>

## 1.3 Documentation Issue Status

Version	Comment
3.0.0	<ul style="list-style-type: none"> <li>• Migration</li> </ul>
2.2.0	<ul style="list-style-type: none"> <li>• Mounting and wiring updated</li> <li>• Technical data updated</li> <li>• ATEX notes added</li> <li>• Extended temperature range for KL3404-0000 and KL3464-0000</li> </ul>
2.1.2	<ul style="list-style-type: none"> <li>• Connection corrected</li> </ul>
2.1.1	<ul style="list-style-type: none"> <li>• Technical data updated</li> <li>• Register description updated</li> <li>• Description of the KS2000 settings updated</li> <li>• Firmware and hardware versions updated</li> </ul>
2.1.0	<ul style="list-style-type: none"> <li>• Infinite Impulse Response filter (IIR) added</li> <li>• Register description updated</li> <li>• Description of the KS2000 configuration software updated</li> </ul>
2.0.0	Eight channel Bus Terminals added: KL3408-0000 and KL3468-0000
1.1	Connection of reference ground corrected
1.0	First release
0.1	Internal proof copy

### Firmware and hardware versions

Documenta- tion Version	KL3404-0000		KL3408-0000		KL3464-0000		KL3468-0000	
	Firmware	Hard- ware	Firmware	Hard- ware	Firmware	Hardware	Firmware	Hardware
3.0.0	1E	06	1D	06	1F	06	1D	06
2.2.0	1E	01	1C	01	1E	01	1C	01
2.1.2	1E	01	1C	01	1E	01	1C	01
2.1.1	1E	01	1C	01	1E	01	1C	01
2.1.0	1E	00	1C	00	1E	00	1C	00
2.0.0	1D	00	1B	00	1D	00	1B	00

The firmware and hardware versions (delivery state) can be found in the serial number printed on the side of the terminal.

### Syntax of the serial number

Structure of the serial number: WW YY FF HH

WW - week of production (calendar week)

YY - year of production

FF - firmware version

HH - hardware version

Example with ser. no.: 35 04 1B 01:

35 - week of production 35

04 - year of production 2004

1B - firmware version 1B

01 - hardware version 01

## 2 KL3404-KL3464 –Product overview

### 2.1 Introduction

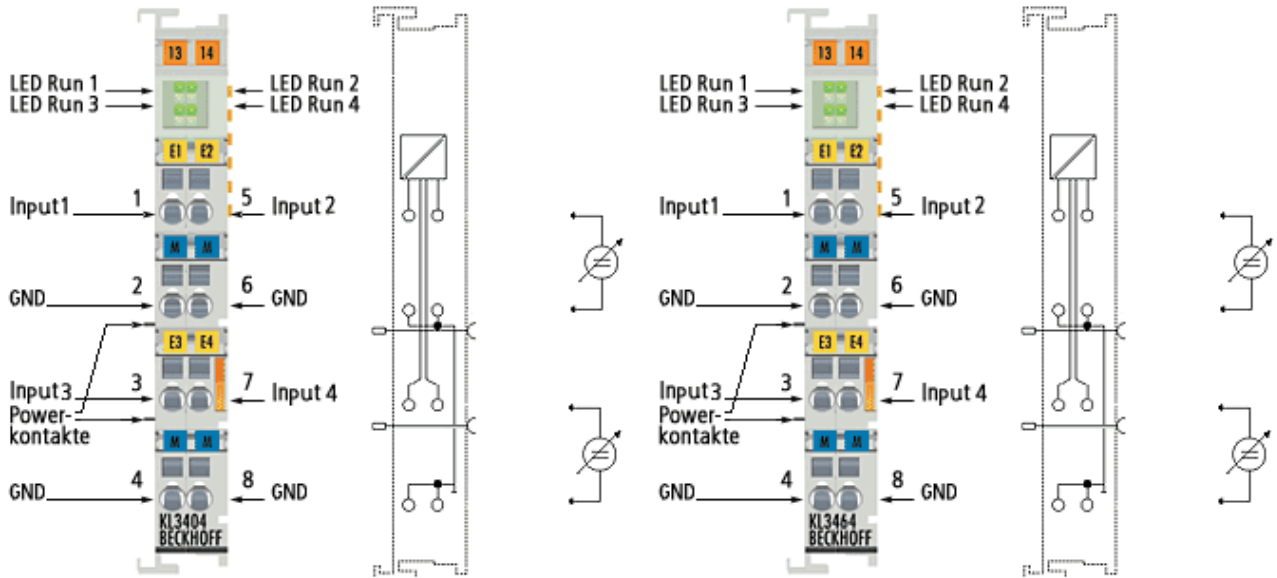

Fig. 1: KL3404, KL3464

The KL3404 and KL3464 analog input terminals process signals in the ranges -10 V to +10 V or 0 V to 10 V. The voltage is digitized to a resolution of 12 bits, and is transmitted, electrically isolated, to the higher-level automation device. In the KL3404 and KL3464 Bus Terminals, the four inputs are 2-wire versions and have a common ground potential. This reference ground of the inputs is electrically isolated from the 0 V power contact. The power contacts are connected through. The LEDs indicate the data exchange with the Bus Coupler.



## 2.2 Technical data

Technical data	KL3404-0000	KL3464-0000
Number of inputs	4	
Signal voltage	-10 V...+10 V	0 ...+10 V
Internal resistance	> 130 kΩ	
Resolution	12 bit (for 0 to 10 V: 11 bit)	12 bit
Conversion time	approx. 2 ms	
Measuring error (total measuring range)	< ± 0.30% of the full scale value < ± 0.75% of full scale value (when the extended temperature range is used)	
Electrical isolation	500 V (K-bus/signal voltage)	
Power supply for the electronics	via the K-bus	
Current consumption from the K-bus	typically 100 mA	
Bit width in process image	Input: 4 x 16 bit user data, 4 x 8 bit control/status (optional)	
Weight	approx. 55 g	
Dimensions (W x H x D)	approx. 15 mm x 100 mm x 70 mm	
Mounting [ <a href="#">▶ 17</a> ]	on 35 mm mounting rail conforms to EN 60715	
Permissible ambient temperature range during operation	-25 °C ... +60 °C (extended temperature range [ <a href="#">▶ 26</a> ])	
Permissible ambient temperature range during storage	-40 °C ... + 85 °C	
Permissible relative air humidity	95 %, no condensation	
Vibration / shock resistance	conforms to EN 60068-2-6/EN 60068-2-27, see also <a href="#">Installation instructions for enhanced mechanical load capacity [<a href="#">▶ 19</a>]</a>	
EMC immunity / emission	conforms to EN 61000-6-2 / EN 61000-6-4	
Protection class	IP20	
Installation position	variable	
Approval	CE, cULus, ATEX, GL	

## 2.3 Diagnostic LEDs

The four green RUN LEDs indicated the operating state of the terminal channels.

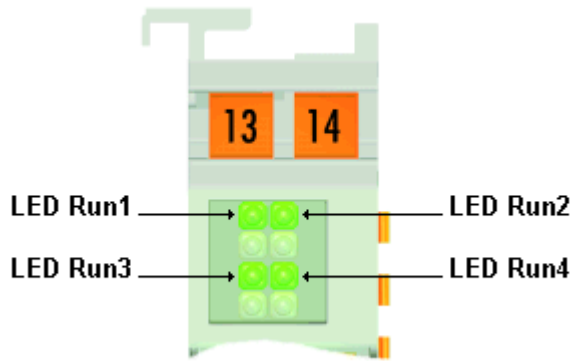

Fig. 2: LEDs

### Meaning of the LED displays

LED	Color	Channel	State	
			on	off
Run1	green	1	normal operation	A watchdog timer overflow has occurred. The green LEDs go out if no process data are transferred between the controller and the Bus Coupler for more than 100 ms.
Run2		2		
Run3		3		
Run4		4		

### 3 KL3408, KL3468 - Product overview

#### 3.1 Introduction

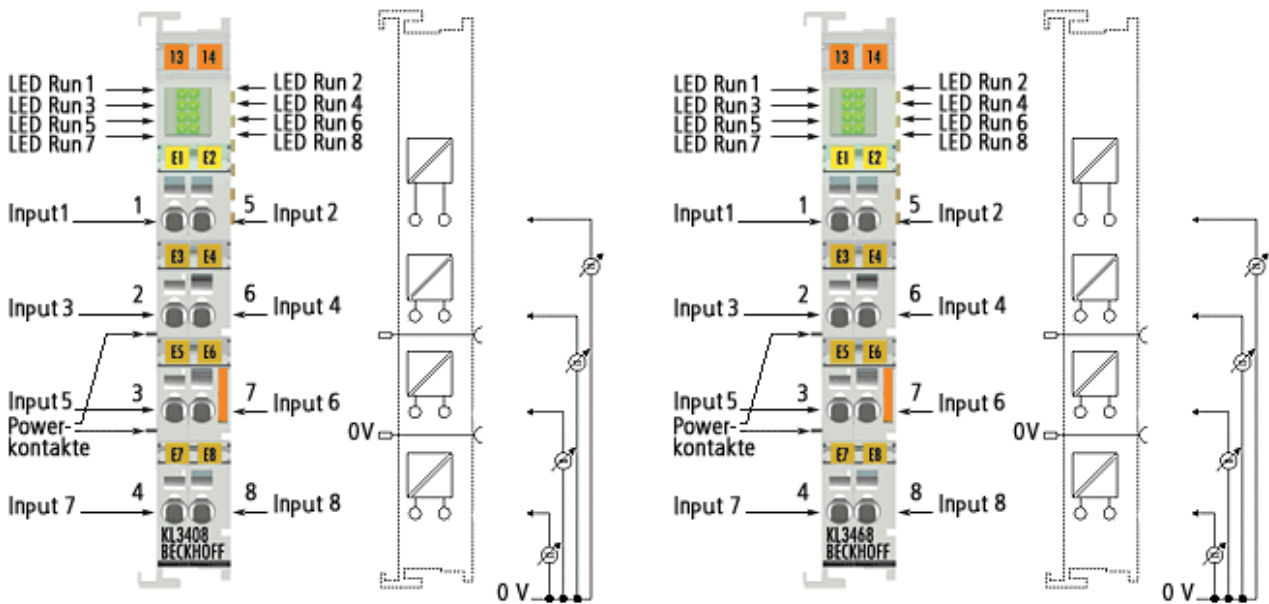

Fig. 3: KL3408 and KL3468

The KL3408 and KL3468 analog input terminals process signals in the ranges -10 V to +10 V or 0 V to 10 V. The voltage is digitized to a resolution of 12 bits, and is transmitted, electrically isolated, to the higher-level automation device. The KL3408 and KL3468 variants combine 8 channels in one housing and are particularly suitable for space saving installation in control cabinets. The use of single conductor connection technology enables the connection of multi-channel sensor technology with minimum space requirements. The power contacts are connected through. The reference ground for all inputs is the 0 V power contact. The LEDs indicate the data exchange with the Bus Coupler.

## 3.2 Technical data

Technical data	KL3408-0000	KL3468-0000
Number of inputs	8	
Signal voltage	-10 V...+10 V	0 ...+10 V
Internal resistance	> 130 kΩ	
Resolution	12 bit (for 0 to 10 V: 11 bit)	12 bit
Conversion time	approx. 4 ms	
Measuring error (total measuring range)	< ±0.3% of the full scale value	
Electrical isolation	500 V (K-bus/signal voltage)	
Power supply for the electronics	via the K-bus	
Current consumption from the K-bus	typically 140 mA	
Bit width in process image	Input: 8 x 16 bit user data, 8 x 8 bit control/status (optional)	
Weight	approx. 55 g	
Dimensions (W x H x D)	approx. 15 mm x 100 mm x 70 mm	
Mounting [ <a href="#">▶ 17</a> ]	on 35 mm mounting rail conforms to EN 60715	
Permissible ambient temperature range during operation	0 °C ... + 55 °C	
Permissible ambient temperature range during storage	-25 °C ... + 85 °C	
Permissible relative air humidity	95 %, no condensation	
Vibration / shock resistance	conforms to EN 60068-2-6/EN 60068-2-27, see also <a href="#">Installation instructions for enhanced mechanical load capacity</a> [ <a href="#">▶ 19</a> ]	
EMC immunity / emission	conforms to EN 61000-6-2 / EN 61000-6-4	
Protection class	IP20	
Installation position	variable	
Approval	CE, cULus, ATEX [ <a href="#">▶ 25</a> ], GL	

### 3.3 Diagnostic LEDs

The eight green Run LEDs indicate the operating states of the terminal channels.

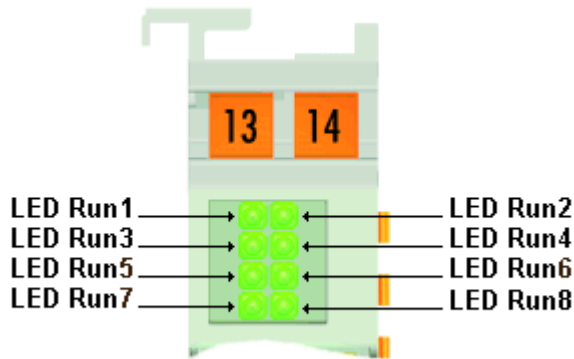

Fig. 4: LEDs

#### Meaning of the LED displays

LED	Color	Channel	State	
			on	off
Run 1	green	1	normal operation	A watchdog timer overflow has occurred. The green LEDs go out if no process data are transferred between the controller and the Bus Coupler for more than 100 ms.
Run 2		2		
Run 3		3		
Run 4		4		
Run 5		5		
Run 6		6		
Run 7		7		
Run 8		8		

## 4 Basic Function Principles

### 4.1 KL3404 and KL3408 - Basic Function Principles

The KL3404 and KL3408 analog input terminals process signals in the range from -10 V to  $\pm 10$  V with a resolution of 12 bits (4095 steps). The inputs are single-ended inputs with a common ground potential.

#### Process data output format

In the delivery state the process data are shown in two's complement form ( $-1_{\text{integer}}$  corresponds to 0xFFFF). Other presentation types can be selected via the feature register R32 (e.g. signed amount representation, Siemens output format).

Measured value	Input data	
	decimal	hexadecimal
-10 V	-32768	0x8000
-5 V	-16383	0xC001
0 V	0	0x0000
$\pm 5$ V	16383	0x3FFF
$\pm 10$ V	32767	0x7FFF

#### Process data equations

The process data that are transferred to the Bus Coupler are calculated using the following equations:

#### Neither user nor manufacturer scaling is active

$$Y_a = (B_a \_ X_{\text{ADC}}) \times A_a \quad (1.0)$$

$$Y_{\text{out}} = Y_a$$

#### Manufacturer scaling active (default setting)

$$Y_1 = B_h \_ A_h \times Y_a \quad (1.1)$$

$$Y_{\text{out}} = Y_1$$

#### User scaling active

$$Y_2 = B_w \_ A_w \times Y_a \quad (1.2)$$

$$Y_{\text{out}} = Y_2$$

#### Manufacturer and user scaling active

$$Y_1 = B_h \_ A_h \times Y_a \quad (1.3)$$

$$Y_2 = B_w \_ A_w \times Y_1 \quad (1.4)$$

$$Y_{\text{out}} = Y_2$$

#### Key

$X_{\text{ADC}}$ :	Output values of the A/D converter	
$Y_{\text{out}}$ :	Process data to PLC	
$B_a, A_a$ :	Manufacturer gain and offset compensation	(R17 [▶ 41], R18 [▶ 41])
$B_h, A_h$ :	Manufacturer scaling	(R19 [▶ 41], R20 [▶ 41])
$B_w, A_w$ :	User scaling	(R33 [▶ 44], R34 [▶ 44])

The equations of the straight line are enabled via register R32.

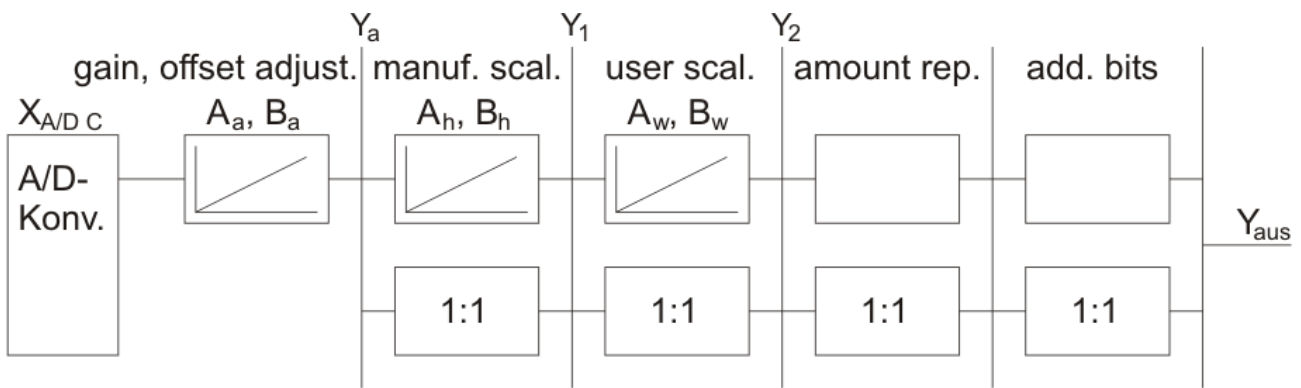

Fig. 5: Signal processing

## 4.2 KL3464 and KL3468 - Basic Function Principles

The KL3464 and KL3468 analog input terminals process signals in the range from -0 V to +10 V with a resolution of 12 bits (4095 steps). The inputs are single-ended inputs with a common ground potential.

### Process data output format

In the delivery state the process data are shown in two's complement form ( $-1_{integer}$  corresponds to 0xFFFF). Other presentation types can be selected via the feature register R32 (e.g. signed amount representation, Siemens output format).

Measured value	Input data	
	decimal	hexadecimal
0 V	0	0x0000
+5 V	16383	0x3FFF
+10 V	32767	0x7FFF

### Process data equations

The process data that are transferred to the Bus Coupler are calculated using the following equations:

#### Neither user nor manufacturer scaling is active

$$Y_a = (B_a + X_{ADC}) \times A_a \quad (1.0)$$

$$Y_{out} = Y_a$$

#### Manufacturer scaling active (default setting)

$$Y_1 = B_h + A_h \times Y_a \quad (1.1)$$

$$Y_{out} = Y_1$$

#### User scaling active

$$Y_2 = B_w + A_w \times Y_a \quad (1.2)$$

$$Y_{out} = Y_2$$

#### Manufacturer and user scaling active

$$Y_1 = B_h + A_h \times Y_a \quad (1.3)$$

$$Y_2 = B_w + A_w \times Y_1 \quad (1.4)$$

$$Y_{out} = Y_2$$

**Key**

$X_{ADC}$ :	Output values of the A/D converter	
$Y_{out}$ :	Process data to PLC	
$B_a, A_a$ :	Manufacturer gain and offset compensation	(R17 [▶ 41], R18 [▶ 41])
$B_h, A_h$ :	Manufacturer scaling	(R19 [▶ 41], R20 [▶ 41])
$B_w, A_w$ :	User scaling	(R33 [▶ 44], R34 [▶ 44])

The equations of the straight line are enabled via register R32.

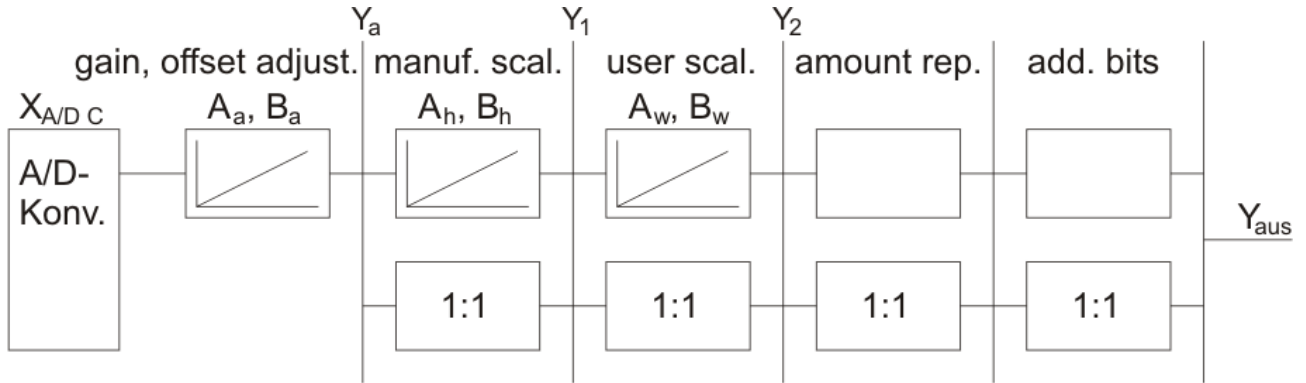



Fig. 6: Signal processing



## 5 Mounting and wiring

### 5.1 Installation on mounting rails

 <b>WARNING</b>	<p><b>Risk of electric shock and damage of device!</b></p> <p>Bring the bus terminal system into a safe, powered down state before starting installation, disassembly or wiring of the Bus Terminals!</p>
---	---

**Assembly**

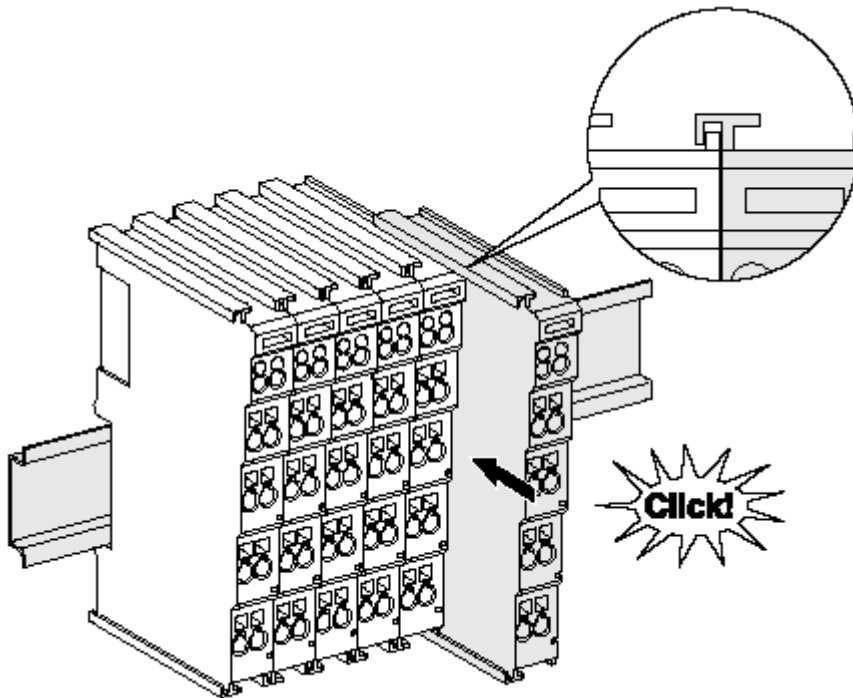



Fig. 7: Attaching on mounting rail

The Bus Coupler and Bus Terminals are attached to commercially available 35 mm mounting rails (DIN rails according to EN 60715) by applying slight pressure:

1. First attach the Fieldbus Coupler to the mounting rail.
2. The Bus Terminals are now attached on the right-hand side of the Fieldbus Coupler. Join the components with tongue and groove and push the terminals against the mounting rail, until the lock clicks onto the mounting rail.

If the Terminals are clipped onto the mounting rail first and then pushed together without tongue and groove, the connection will not be operational! When correctly assembled, no significant gap should be visible between the housings.

 <b>Note</b>	<p><b>Fixing of mounting rails</b></p> <p>The locking mechanism of the terminals and couplers extends to the profile of the mounting rail. At the installation, the locking mechanism of the components must not come into conflict with the fixing bolts of the mounting rail. To mount the mounting rails with a height of 7.5 mm under the terminals and couplers, you should use flat mounting connections (e.g. countersunk screws or blind rivets).</p>
--	---

## Disassembly

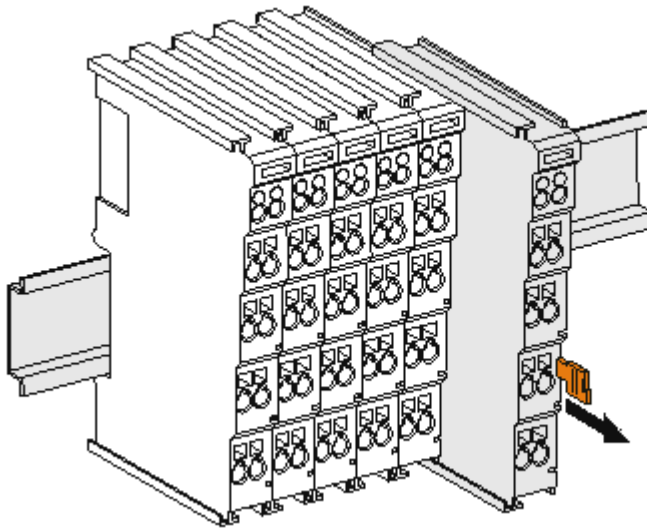

Fig. 8: Disassembling of terminal

Each terminal is secured by a lock on the mounting rail, which must be released for disassembly:

1. Pull the terminal by its orange-colored lugs approximately 1 cm away from the mounting rail. In doing so for this terminal the mounting rail lock is released automatically and you can pull the terminal out of the bus terminal block easily without excessive force.
2. Grasp the released terminal with thumb and index finger simultaneous at the upper and lower grooved housing surfaces and pull the terminal out of the bus terminal block.

## Connections within a bus terminal block

The electric connections between the Bus Coupler and the Bus Terminals are automatically realized by joining the components:

- The six spring contacts of the K-Bus/E-Bus deal with the transfer of the data and the supply of the Bus Terminal electronics.
- The power contacts deal with the supply for the field electronics and thus represent a supply rail within the bus terminal block. The power contacts are supplied via terminals on the Bus Coupler (up to 24 V) or for higher voltages via power feed terminals.



### Note

#### Power Contacts

During the design of a bus terminal block, the pin assignment of the individual Bus Terminals must be taken account of, since some types (e.g. analog Bus Terminals or digital 4-channel Bus Terminals) do not or not fully loop through the power contacts. Power Feed Terminals (KL91xx, KL92xx or EL91xx, EL92xx) interrupt the power contacts and thus represent the start of a new supply rail.

## PE power contact

The power contact labeled PE can be used as a protective earth. For safety reasons this contact mates first when plugging together, and can ground short-circuit currents of up to 125 A.

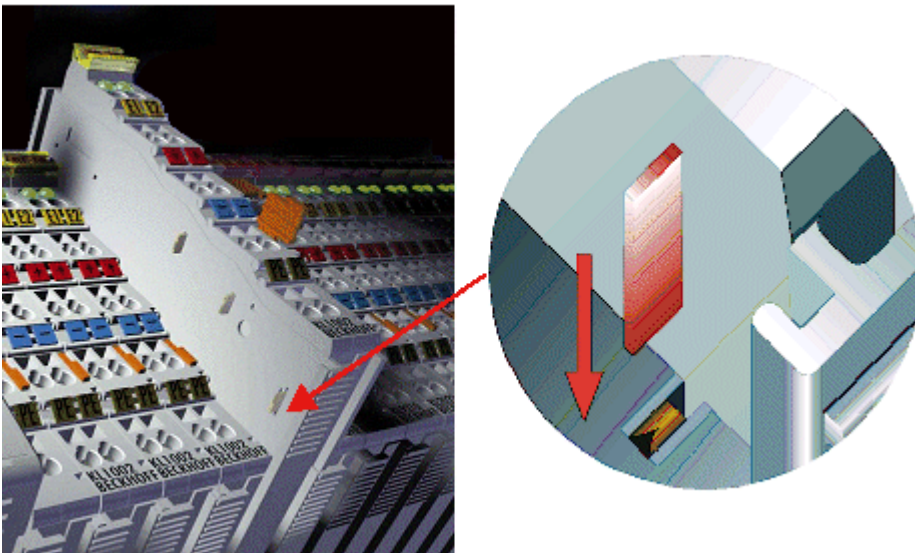





Fig. 9: Power contact on left side

 <b>Attention</b>	<p><b>Possible damage of the device</b></p> <p>Note that, for reasons of electromagnetic compatibility, the PE contacts are capacitatively coupled to the mounting rail. This may lead to incorrect results during insulation testing or to damage on the terminal (e.g. disruptive discharge to the PE line during insulation testing of a consumer with a nominal voltage of 230 V). For insulation testing, disconnect the PE supply line at the Bus Coupler or the Power Feed Terminal! In order to decouple further feed points for testing, these Power Feed Terminals can be released and pulled at least 10 mm from the group of terminals.</p>
---	---

 <b>WARNING</b>	<p><b>Risk of electric shock!</b></p> <p>The PE power contact must not be used for other potentials!</p>
---	--

## 5.2 Installation instructions for enhanced mechanical load capacity

 <b>WARNING</b>	<p><b>Risk of injury through electric shock and damage to the device!</b></p> <p>Bring the Bus Terminal system into a safe, de-energized state before starting mounting, disassembly or wiring of the Bus Terminals!</p>
---	--

### Additional checks

The terminals have undergone the following additional tests:

Verification	Explanation
Vibration	10 frequency runs in 3 axes
	6 Hz < f < 60 Hz displacement 0.35 mm, constant amplitude
	60.1 Hz < f < 500 Hz acceleration 5 g, constant amplitude
Shocks	1000 shocks in each direction, in 3 axes
	25 g, 6 ms

## Additional installation instructions

For terminals with enhanced mechanical load capacity, the following additional installation instructions apply:

- The enhanced mechanical load capacity is valid for all permissible installation positions
- Use a mounting rail according to EN 60715 TH35-15
- Fix the terminal segment on both sides of the mounting rail with a mechanical fixture, e.g. an earth terminal or reinforced end clamp
- The maximum total extension of the terminal segment (without coupler) is: 64 terminals (12 mm mounting with) or 32 terminals (24 mm mounting with)
- Avoid deformation, twisting, crushing and bending of the mounting rail during edging and installation of the rail
- The mounting points of the mounting rail must be set at 5 cm intervals
- Use countersunk head screws to fasten the mounting rail
- The free length between the strain relief and the wire connection should be kept as short as possible. A distance of approx. 10 cm should be maintained to the cable duct.

## 5.3 Connection

### 5.3.1 Connection system

	<p><b>Risk of electric shock and damage of device!</b></p> <p>Bring the bus terminal system into a safe, powered down state before starting installation, disassembly or wiring of the Bus Terminals!</p>
<p><b>WARNING</b></p>	

#### Overview

The Bus Terminal system offers different connection options for optimum adaptation to the respective application:

- The terminals of ELxxxx and KLxxxx series with standard wiring include electronics and connection level in a single enclosure.
- The terminals of ESxxxx and KSxxxx series feature a pluggable connection level and enable steady wiring while replacing.
- The High Density Terminals (HD Terminals) include electronics and connection level in a single enclosure and have advanced packaging density.

#### Standard wiring (ELxxxx / KLxxxx)



Fig. 10: Standard wiring

The terminals of ELxxxx and KLxxxx series have been tried and tested for years. They feature integrated screwless spring force technology for fast and simple assembly.

**Pluggable wiring (ESxxxx / KSxxxx)**

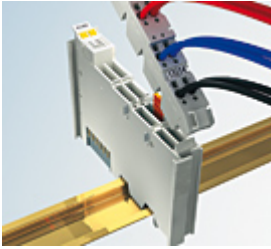

Fig. 11: Pluggable wiring

The terminals of ESxxxx and KSxxxx series feature a pluggable connection level. The assembly and wiring procedure for the KS series is the same as for the ELxxxx and KLxxxx series. The KS/ES series terminals enable the complete wiring to be removed as a plug connector from the top of the housing for servicing. The lower section can be removed from the terminal block by pulling the unlocking tab. Insert the new component and plug in the connector with the wiring. This reduces the installation time and eliminates the risk of wires being mixed up.

The familiar dimensions of the terminal only had to be changed slightly. The new connector adds about 3 mm. The maximum height of the terminal remains unchanged.

A tab for strain relief of the cable simplifies assembly in many applications and prevents tangling of individual connection wires when the connector is removed.

Conductor cross sections between 0.08 mm<sup>2</sup> and 2.5 mm<sup>2</sup> can continue to be used with the proven spring force technology.

The overview and nomenclature of the product names for ESxxxx and KSxxxx series has been retained as known from ELxxxx and KLxxxx series.

**High Density Terminals (HD Terminals)**



Fig. 12: High Density Terminals

The Bus Terminals from these series with 16 terminal points are distinguished by a particularly compact design, as the packaging density is twice as large as that of the standard 12 mm Bus Terminals. Massive conductors and conductors with a wire end sleeve can be inserted directly into the spring loaded terminal point without tools.

 <b>Note</b>	<p><b>Wiring HD Terminals</b></p> <p>The High Density (HD) Terminals of the ELx8xx and KLx8xx series doesn't support pluggable wiring.</p>
--	--

**Ultrasonically "bonded" (ultrasonically welded) conductors**

 <b>Note</b>	<p><b>Ultrasonically "bonded" conductors</b></p> <p>It is also possible to connect the Standard and High Density Terminals with ultrasonically "bonded" (ultrasonically welded) conductors. In this case, please note the tables concerning the wire-size width below!</p>
--	--

### 5.3.2 Wiring



**WARNING**

#### Risk of electric shock and damage of device!

Bring the bus terminal system into a safe, powered down state before starting installation, disassembly or wiring of the Bus Terminals!

#### Terminals for standard wiring ELxxxx/KLxxxx and for pluggable wiring ESxxxx/KSxxxx

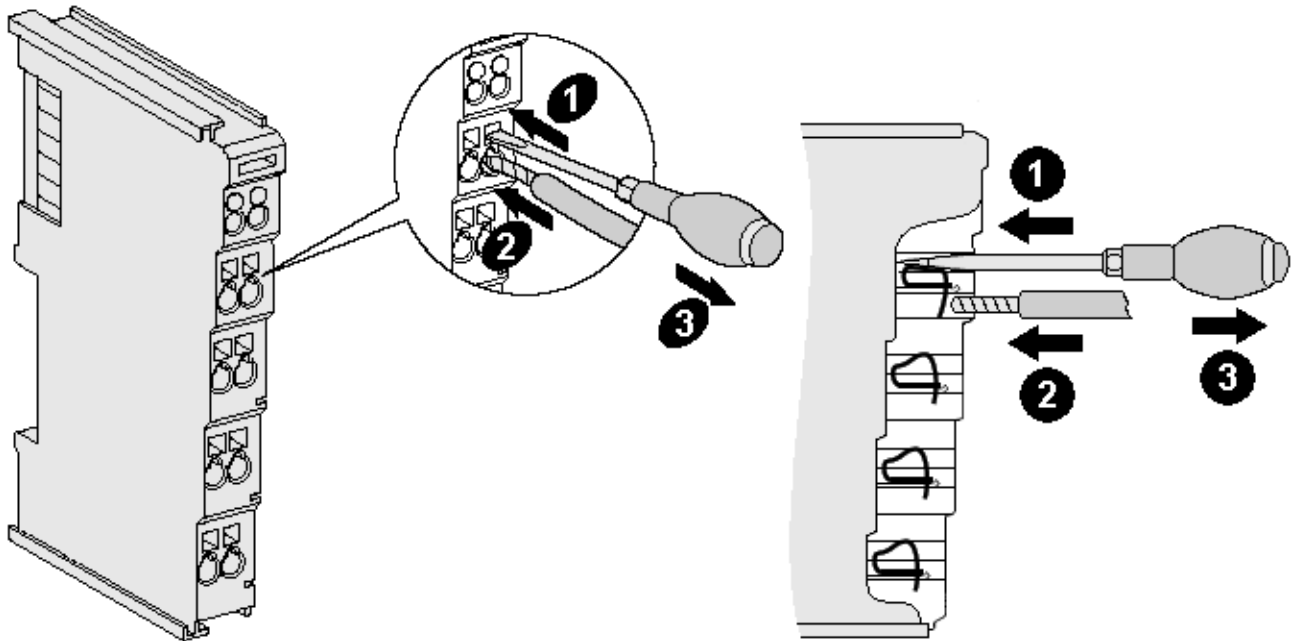

Fig. 13: Connecting a cable on a terminal point

Up to eight terminal points enable the connection of solid or finely stranded cables to the Bus Terminal. The terminal points are implemented in spring force technology. Connect the cables as follows:

1. Open a terminal point by pushing a screwdriver straight against the stop into the square opening above the terminal point. Do not turn the screwdriver or move it alternately (don't toggle).
2. The wire can now be inserted into the round terminal opening without any force.
3. The terminal point closes automatically when the pressure is released, holding the wire securely and permanently.

See the following table for the suitable wire size width.

Terminal housing	ELxxxx, KLxxxx	ESxxxx, KSxxxx
Wire size width (single core wires)	0.08 ... 2.5 mm <sup>2</sup>	0.08 ... 2.5 mm <sup>2</sup>
Wire size width (fine-wire conductors)	0.08 ... 2.5 mm <sup>2</sup>	0,08 ... 2.5 mm <sup>2</sup>
Wire size width (conductors with a wire end sleeve)	0.14 ... 1.5 mm <sup>2</sup>	0.14 ... 1.5 mm <sup>2</sup>
Wire stripping length	8 ... 9 mm	9 ... 10 mm

#### High Density Terminals ([HD Terminals](#) [► 21]) with 16 terminal points

The conductors of the HD Terminals are connected without tools for single-wire conductors using the direct plug-in technique, i.e. after stripping the wire is simply plugged into the terminal point. The cables are released, as usual, using the contact release with the aid of a screwdriver. See the following table for the suitable wire size width.

<b>Terminal housing</b>	<b>High Density Housing</b>
<b>Wire size width (single core wires)</b>	0.08 ... 1.5 mm <sup>2</sup>
<b>Wire size width (fine-wire conductors)</b>	0.25 ... 1.5 mm <sup>2</sup>
<b>Wire size width (conductors with a wire end sleeve)</b>	0.14 ... 0.75 mm <sup>2</sup>
<b>Wire size width (ultrasonically "bonded" conductors)</b>	only 1.5 mm <sup>2</sup>
<b>Wire stripping length</b>	8 ... 9 mm

### 5.3.3 Shielding

 <b>Note</b>	<p><b>Shielding</b></p> <p>Encoder, analog sensors and actors should always be connected with shielded, twisted paired wires.</p>
--	---

### 5.3.4 KL3404, KL3464 - connection

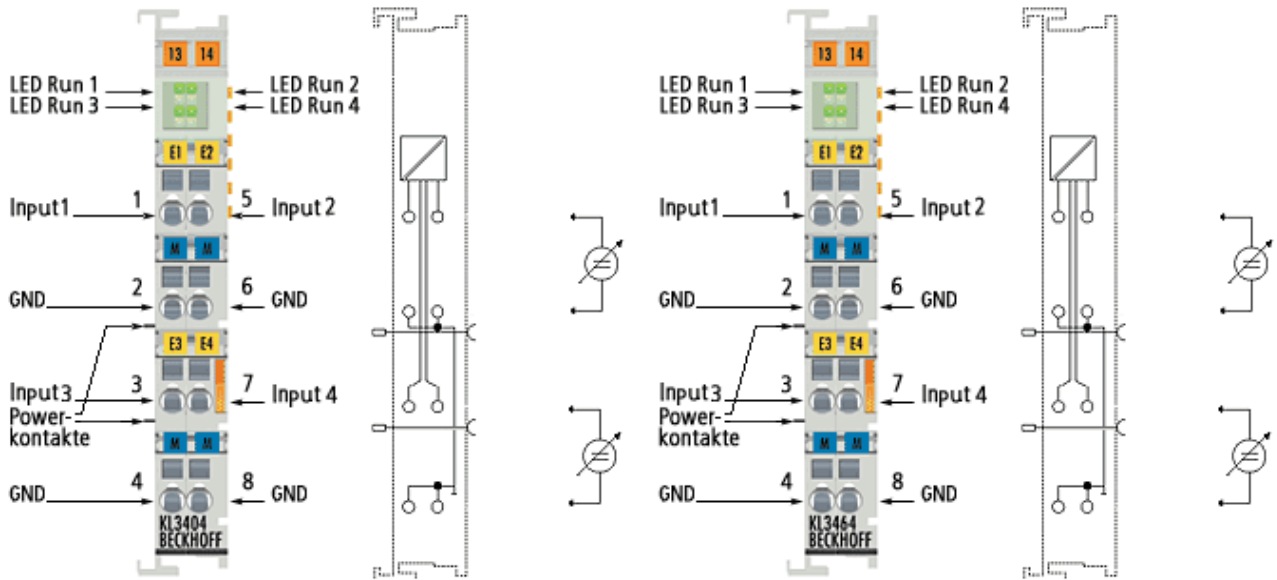

Fig. 14: Connection KL3404 and KL3464

Terminal point no.	Channel	Name	Connection for
1	1	Input 1	Input 1, signal
2		GND	Input 1, ground
3	3	Input 3	Input 3, signal
4		GND	Input 3, ground
5	2	Input 2	Input 2, signal
6		GND	Input 2, ground
7	4	Input 4	Input 4, signal
8		GND	Input 4, ground

### 5.3.5 KL3408, KL3468 - connection

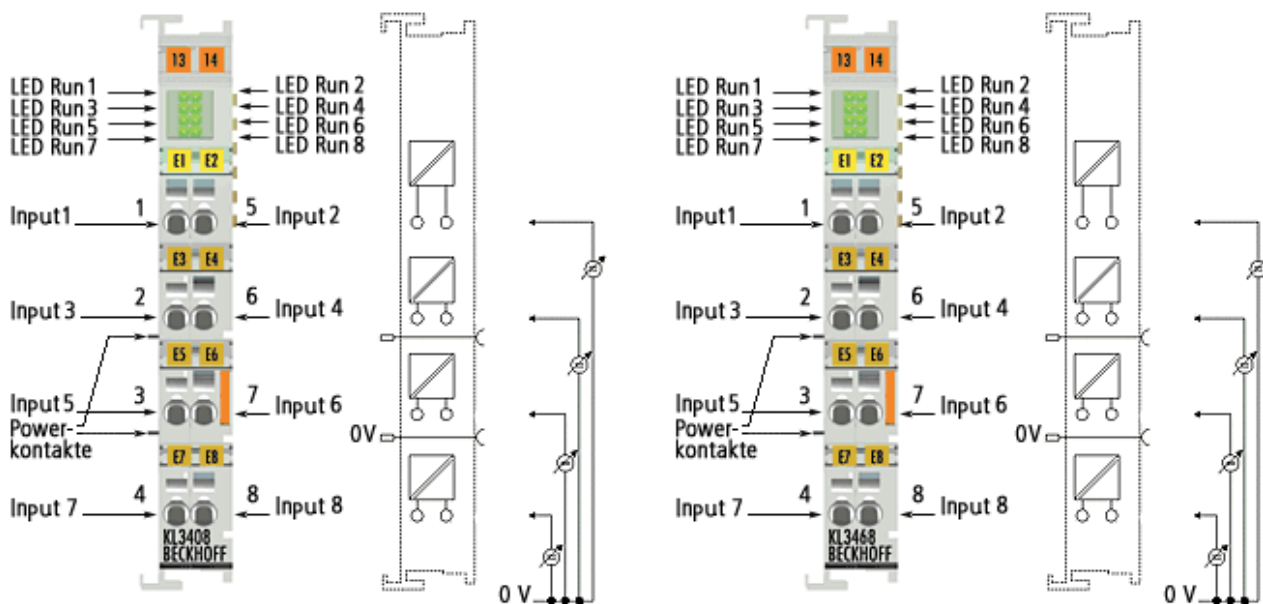

Fig. 15: Connection KL3408 and KL3468

Terminal point no.	Channel	Name	Connection for
1	1	Input 1	Input 1, signal
2	3	Input 3	Input 3, signal
3	5	Input 5	Input 5, signal
4	7	Input 7	Input 7, signal
5	2	Input 2	Input 2, signal
6	4	Input 4	Input 4, signal
7	6	Input 6	Input 6, signal
8	8	Input 8	Input 8, signal



## 5.4 ATEX - Special conditions (standard temperature range)



**WARNING**

**Observe the special conditions for the intended use of Beckhoff fieldbus components with standard temperature range in potentially explosive areas (directive 94/9/EU)!**

- The certified components are to be installed in a suitable housing that guarantees a protection class of at least IP54 in accordance with EN 60529! The environmental conditions during use are thereby to be taken into account!
- If the temperatures during rated operation are higher than 70°C at the feed-in points of cables, lines or pipes, or higher than 80°C at the wire branching points, then cables must be selected whose temperature data correspond to the actual measured temperature values!
- Observe the permissible ambient temperature range of 0 to 55°C for the use of Beckhoff fieldbus components standard temperature range in potentially explosive areas!
- Measures must be taken to protect against the rated operating voltage being exceeded by more than 40% due to short-term interference voltages!
- The individual terminals may only be unplugged or removed from the Bus Terminal system if the supply voltage has been switched off or if a non-explosive atmosphere is ensured!
- The connections of the certified components may only be connected or disconnected if the supply voltage has been switched off or if a non-explosive atmosphere is ensured!
- The fuses of the KL92xx/EL92xx power feed terminals may only be exchanged if the supply voltage has been switched off or if a non-explosive atmosphere is ensured!
- Address selectors and ID switches may only be adjusted if the supply voltage has been switched off or if a non-explosive atmosphere is ensured!

### Standards

The fundamental health and safety requirements are fulfilled by compliance with the following standards:

- EN 60079-0:2012+A11:2013
- EN 60079-15:2010

### Marking

The Beckhoff fieldbus components with standard temperature range certified for potentially explosive areas bear one of the following markings:



II 3G KEMA 10ATEX0075 X Ex nA IIC T4 Gc Ta: 0 ... 55°C

or



II 3G KEMA 10ATEX0075 X Ex nC IIC T4 Gc Ta: 0 ... 55°C

## 5.5 ATEX - Special conditions (extended temperature range)



**WARNING**

**Observe the special conditions for the intended use of Beckhoff fieldbus components with extended temperature range (ET) in potentially explosive areas (directive 94/9/EU)!**

- The certified components are to be installed in a suitable housing that guarantees a protection class of at least IP54 in accordance with EN 60529! The environmental conditions during use are thereby to be taken into account!
- If the temperatures during rated operation are higher than 70°C at the feed-in points of cables, lines or pipes, or higher than 80°C at the wire branching points, then cables must be selected whose temperature data correspond to the actual measured temperature values!
- Observe the permissible ambient temperature range of -25 to 60°C for the use of Beckhoff fieldbus components with extended temperature range (ET) in potentially explosive areas!
- Measures must be taken to protect against the rated operating voltage being exceeded by more than 40% due to short-term interference voltages!
- The individual terminals may only be unplugged or removed from the Bus Terminal system if the supply voltage has been switched off or if a non-explosive atmosphere is ensured!
- The connections of the certified components may only be connected or disconnected if the supply voltage has been switched off or if a non-explosive atmosphere is ensured!
- The fuses of the KL92xx/EL92xx power feed terminals may only be exchanged if the supply voltage has been switched off or if a non-explosive atmosphere is ensured!
- Address selectors and ID switches may only be adjusted if the supply voltage has been switched off or if a non-explosive atmosphere is ensured!

### Standards

The fundamental health and safety requirements are fulfilled by compliance with the following standards:

- EN 60079-0:2012+A11:2013
- EN 60079-15:2010

### Marking

The Beckhoff fieldbus components with extended temperature range (ET) certified for potentially explosive areas bear the following marking:



II 3G KEMA 10ATEX0075 X Ex nA IIC T4 Gc Ta: -25 ... 60°C

or



II 3G KEMA 10ATEX0075 X Ex nC IIC T4 Gc Ta: -25 ... 60°C

## 5.6 ATEX Documentation



Note

**Notes about operation of the Beckhoff terminal systems in potentially explosive areas (ATEX)**

Pay also attention to the continuative documentation

Notes about operation of the Beckhoff terminal systems in potentially explosive areas (ATEX)

that is available in the download area of the Beckhoff homepage <http://www.beckhoff.com>!

## 6 KS2000 Configuration Software

### 6.1 KS2000 - Introduction

The KS2000 configuration software permits configuration, commissioning and parameterization of bus couplers, of the affiliated bus terminals and of Fieldbus Box Modules. The connection between bus coupler / Fieldbus Box Module and the PC is established by means of the serial configuration cable or the fieldbus.



Fig. 16: KS2000 configuration software

#### Configuration

You can configure the Fieldbus stations with the Configuration Software KS2000 offline. That means, setting up a terminal station with all settings on the couplers and terminals resp. the Fieldbus Box Modules can be prepared before the commissioning phase. Later on, this configuration can be transferred to the terminal station in the commissioning phase by means of a download. For documentation purposes, you are provided with the breakdown of the terminal station, a parts list of modules used and a list of the parameters you have modified. After an upload, existing fieldbus stations are at your disposal for further editing.

#### Parameterization

KS2000 offers simple access to the parameters of a fieldbus station: specific high-level dialogs are available for all bus couplers, all intelligent bus terminals and Fieldbus Box modules with the aid of which settings can be modified easily. Alternatively, you have full access to all internal registers of the bus couplers and intelligent terminals. Refer to the register description for the meanings of the registers.

## Commissioning

The KS2000 software facilitates commissioning of machine components or their fieldbus stations: Configured settings can be transferred to the fieldbus modules by means of a download. After a *login* to the terminal station, it is possible to define settings in couplers, terminals and Fieldbus Box modules directly *online*. The same high-level dialogs and register access are available for this purpose as in the configuration phase.

The KS2000 offers access to the process images of the bus couplers and Fieldbus Box modules.

- Thus, the coupler's input and output images can be observed by monitoring.
- Process values can be specified in the output image for commissioning of the output modules.

All possibilities in the *online mode* can be used in parallel with the actual fieldbus mode of the terminal station. The fieldbus protocol always has the higher priority in this case.

## 6.2 Parameterization with KS2000

Connect the configuration interface of your Fieldbus Coupler with the serial interface of your PC via the configuration cable and start the *KS2000* Configuration Software.



Click on the *Login* button. The configuration software will now load the information for the connected fieldbus station.

In the example shown, this is

- a BK9000 Bus Coupler for Ethernet
- a KL1xx2 Digital Input Terminal
- a KL3404 Analog Input Terminal
- a KL9010 Bus End Terminal

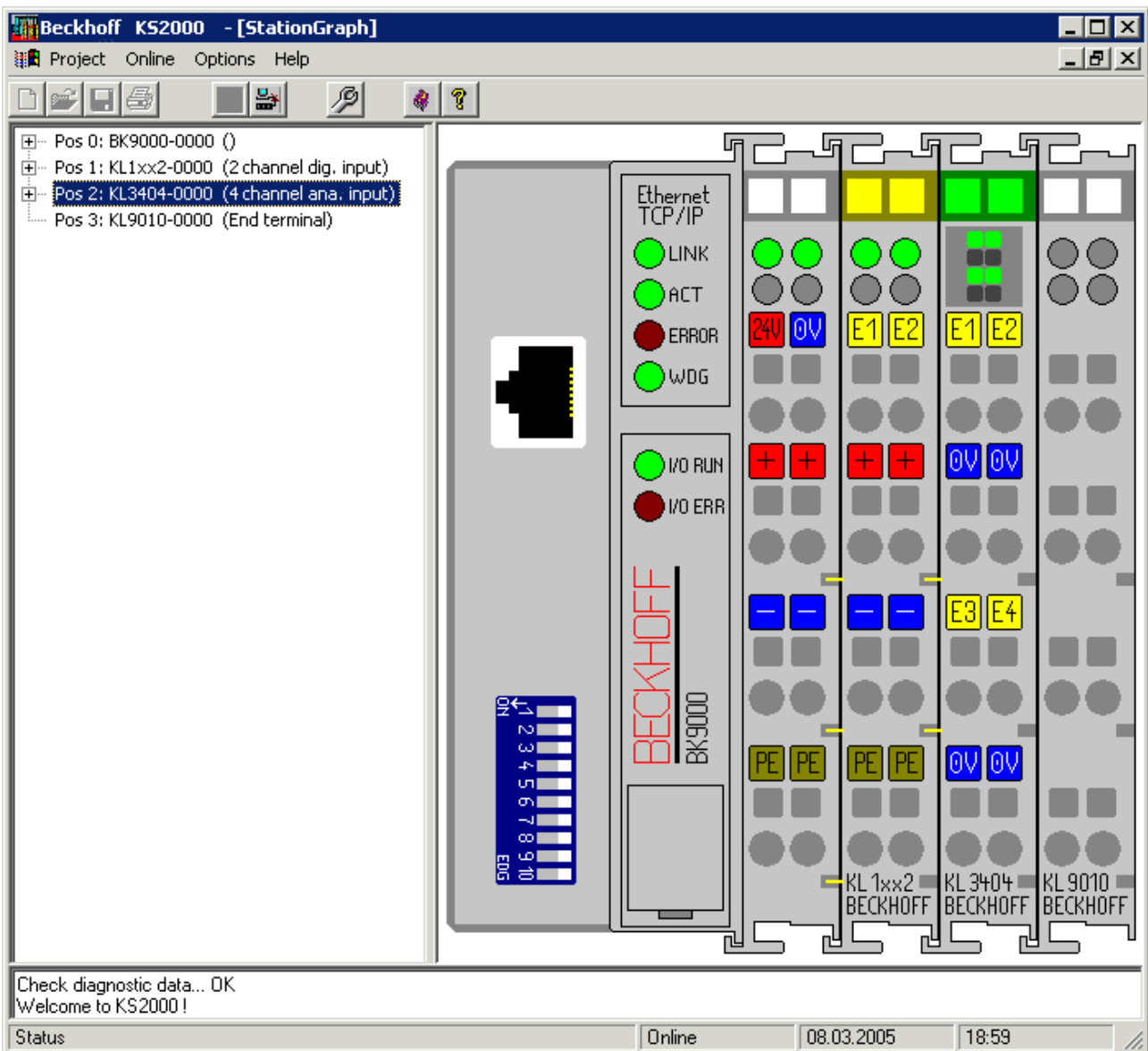

Fig. 17: Display of the fieldbus station in KS2000

The left-hand KS2000 window displays the terminals of the fieldbus station in a tree structure. The right-hand KS2000 window contains a graphic display of the fieldbus station terminals.

In the tree structure of the left-hand window, click on the plus-sign next to the terminal whose parameters you wish to change (item 2 in the example).

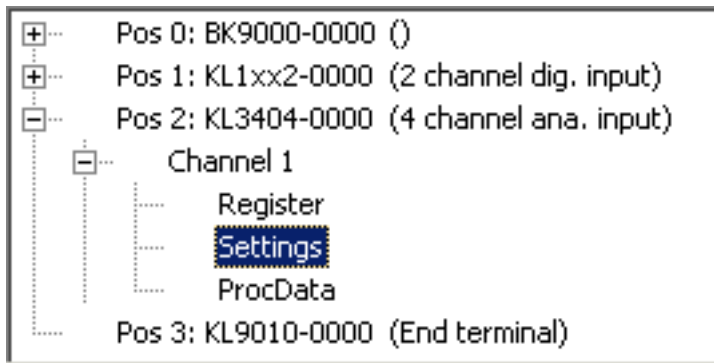

Fig. 18: KS2000 tree branch for channel 1 of the KL3404

For the KL3404, the branches *Register*, *Settings* and *ProcData* are displayed:

- [Register \[▶ 33\]](#) enables direct access to the KL3404 registers.
- Dialog masks for the parameterization of the KL3404 can be found under [Settings \[▶ 31\]](#).
- ProcData shows the process data of the KL3404.

### 6.3 Settings

The dialog mask for the parameterization of the KL3404, KL3408, KL3464 or KL3468 can be found under *Settings*.

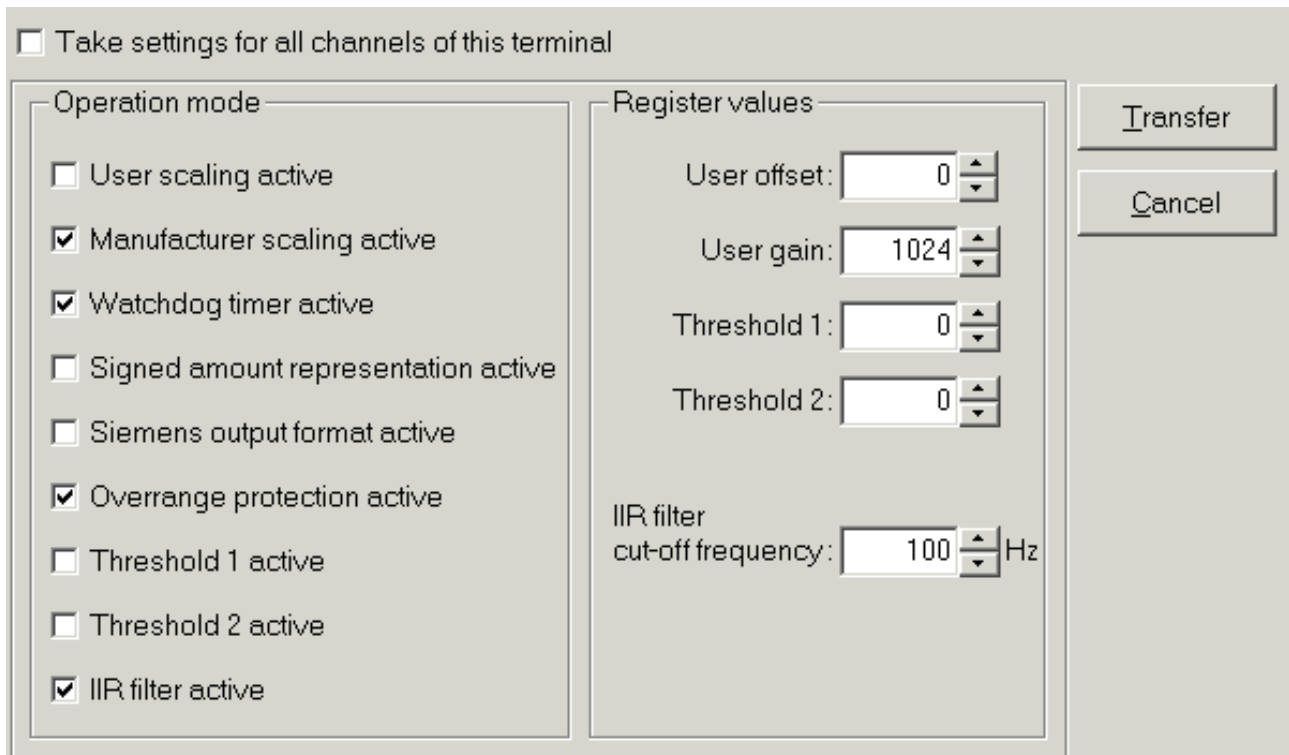

Fig. 19: Settings via KS2000

#### Operation mode

##### User scaling active (R32.0 [▶ 42])

You can activate user scaling here (default: disabled).

**Manufacturer scaling active (R32.1 [▶ 42])**

You can deactivate manufacturer scaling here (default: enabled).

**Watchdog timer active (R32.2 [▶ 42])**

You can deactivate the watchdog timer here (default: enabled).

**Signed amount representation (R32.3 [▶ 42])**

Here you can enable the signed amount representation (default: disabled).

**Siemens output format (R32.4 [▶ 42])**

You can activate Siemens output format here (default: disabled).

**Ovrange protection active (R32.8 [▶ 42])**

You can deactivate the overrange protection here (default: enabled).

**Threshold 1 active (R32.9 [▶ 42])**

You can activate the threshold 1 here (default: disabled).

**Threshold 2 active (R32.10 [▶ 42])**

You can activate the threshold 2 here (default: disabled).

**IIR filter active (R32.11 [▶ 42])**

You can deactivate the digital IIR filter (first order) here (default: enabled).

**Register values****User offset (R33 [▶ 44])**

You can specify the user offset here.

**User gain (R34 [▶ 44])**

You can specify the user gain here.

**Threshold 1 (R35 [▶ 44])**

You can specify threshold 1 here.

**Threshold 2 (R36 [▶ 44])**

You can specify threshold 2 here.

**IIR filter cut-off frequency (R37 [▶ 44])**

You can specify the cut-off frequency for the digital IIR filter here.

KL3404, KL3464: default 200 Hz

KL3408, KL3468: default 100 Hz



## 6.4 Register

Under *Register* you can directly access the Registers of the KL3404 or KL3464. The meaning of the register is explained in the [Register Overview \[► 39\]](#).

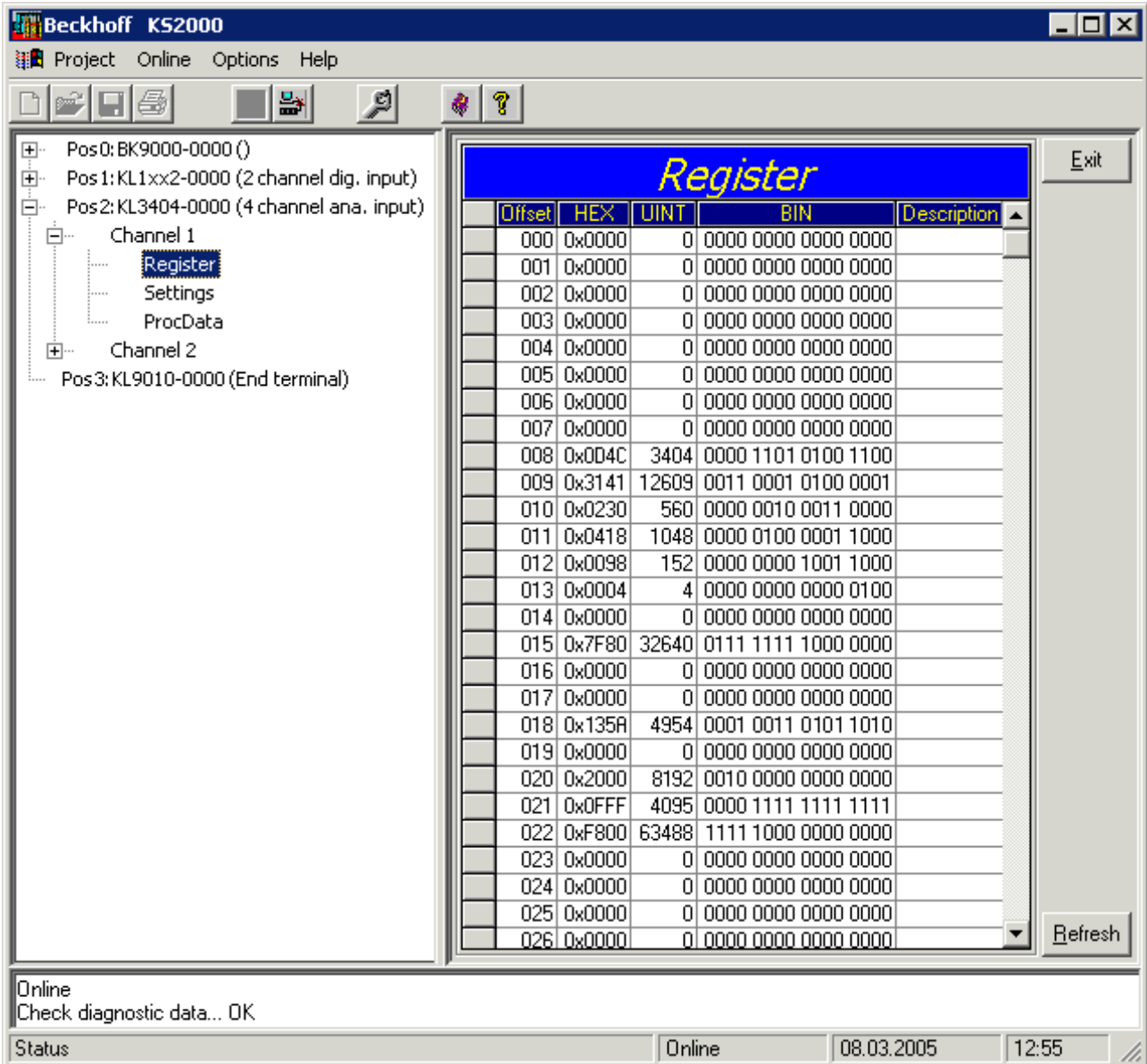

Fig. 20: Register view in KS2000

## 7 Access from the user program

### 7.1 Process image

#### KL3404 and KL3464 as well as KL3444 and KL3454

KL3404 and KL3464 as well as KL3444 and KL3454 represent themselves in the process image with up to 12 bytes of input data and 12 bytes of output data.

Format	Input data	Output data
Byte	SB1 [ <a href="#">▶ 37</a> ]	CB1 [ <a href="#">▶ 37</a> ]
Word	DataIN1	DataOUT1
Byte	SB2	CB2
Word	DataIN2	DataOUT2
Byte	SB3	CB3
Word	DataIN3	DataOUT3
Byte	SB4	CB4
Word	DataIN4	DataOUT4

#### Key

SB n: Status byte for channel n

CB n: Control byte for channel n

DataIN n: Input data word channel n

DataOUT n: Output data word channel n

- Please refer to the [Mapping \[\[▶ 35\]\(#\)\]](#) page for the assignment of the bytes and words to the addresses of the controller.
- The meaning of the control and status bytes is explained in *Control and status bytes*.
- In process data mode the analog values are transferred in input data words DataIN1 to DataIN4. Output data words DataOUT1 to DataOUT4 are not used.

#### KL3408 and KL3468 as well as KL3448 and KL3458

KL3408 and KL3468 as well as KL3448 and KL3458 represent a special case with regard to the process image:

Essentially, two four-channel terminals are accommodated in one terminal housing, which behave like two terminals for the K-bus.

Each of these eight channel analog terminals has the same process image like two four channel terminals of same signal type, plugged next to each other. The KS2000 configuration software and the TwinCAT System Manager display them like two separate four channel analog terminals.



#### Note

#### Special treatment for 8-channel analog terminals

Regarding K-bus diagnosis for your Bus Coupler (e.g. for flashing codes, error code and error argument), note that these eight channel analog terminals are represented as two four channel terminals from a Bus Coupler perspective. If the Bus Coupler is the fault location in the event of an error, you must count each eight channel analog terminal as two terminals!

## 7.2 Mapping

The Bus Terminals occupy addresses within the process image of the controller. The assignment of process data (input and output data) and parameterization data (control and status bytes) to the control addresses is called mapping. The type of mapping depends on:

- the fieldbus system used
- the terminal type
- the parameterization of the Bus Coupler (conditions) such as
  - compact or full evaluation
  - Intel or Motorola format
  - word alignment switched on or off

The Bus Couplers (BKxxxx, LCxxxx) and Bus Terminal Controllers (BCxxxx, BXxxxx) are supplied with certain default settings. The default setting can be changed with the KS2000 configuration software or with a master configuration software (e.g. TwinCAT System Manager or ComProfibus).

The following tables show the mapping depending on different conditions. For information about the contents of the individual bytes please refer to the pages *Process image* and *Control and status byte*.

### Compact evaluation

For compact evaluation, the analog input terminals only occupy addresses in the input process image. Control and status bytes cannot be accessed.

#### Compact evaluation in Intel format

Default mapping for CANopen, CANCEL, DeviceNet, ControlNet, Modbus, RS232 and RS485 coupler

Conditions	Address	Input data		Output data	
	Word offset	High byte	Low byte	High byte	Low byte
Complete evaluation: no	0	Ch1 D1	Ch1 D0	-	-
Motorola format: no	1	Ch2 D1	Ch2 D0	-	-
Word alignment: any	2	Ch3 D1	Ch3 D0	-	-
	3	Ch4 D1	Ch4 D0	-	-

#### Compact evaluation in Motorola format

Default mapping for Profibus and Interbus coupler

Conditions	Address	Input data		Output data	
	Word offset	High byte	Low byte	High byte	Low byte
Complete evaluation: no	0	Ch1 D0	Ch1 D1	-	-
Motorola format: yes	1	Ch2 D0	Ch2 D1	-	-
Word alignment: any	2	Ch3 D0	Ch3 D1	-	-
	3	Ch4 D0	Ch4 D1	-	-

### Complete evaluation

For complete evaluation, the analog input terminals occupy addresses in the input and output process image. Control and status bytes can be accessed.

**Complete evaluation in Intel format**

	Address	Input data		Output data	
Conditions	Word offset	High byte	Low byte	High byte	Low byte
Complete evaluation: yes	0	Ch1 D0	SB1	Ch1 D0	CB1
Motorola format: no	1	SB2	Ch1 D1	CB2	Ch1 D1
Word alignment: no	2	Ch2 D1	Ch2 D0	Ch2 D1	Ch2 D0
	3	Ch3 D0	SB3	Ch3 D0	CB3
	4	SB4	Ch3 D1	CB4	Ch3 D1
	5	Ch4 D1	Ch4 D0	Ch4 D1	Ch4 D0

**Complete evaluation in Motorola format**

	Address	Input data		Output data	
Conditions	Word offset	High byte	Low byte	High byte	Low byte
Complete evaluation: yes	0	Ch1 D1	SB1	Ch1 D1	CB1
Motorola format: yes	1	SB2	Ch1 D0	CB2	Ch1 D0
Word alignment: no	2	Ch2 D0	Ch2 D1	Ch2 D0	Ch2 D1
	3	Ch3 D1	SB3	Ch3 D1	CB3
	4	SB4	Ch3 D0	CB4	Ch3 D0
	5	Ch4 D0	Ch4 D1	Ch4 D0	Ch4 D1

**Complete evaluation in Intel format with word alignment**

Default mapping for Lightbus and Ethernet coupler and Bus Terminal Controller (BCxxxx, BXxxxx)

	Address	Input data		Output data	
Conditions	Word offset	High byte	Low byte	High byte	Low byte
Complete evaluation: yes	0	reserved	SB1	reserved	CB1
Motorola format: no	1	Ch1 D1	Ch1 D0	Ch1 D1	Ch1 D0
Word alignment: yes	2	reserved	SB2	reserved	CB2
	3	Ch2 D1	Ch2 D0	Ch2 D1	Ch2 D0
	4	reserved	SB3	reserved	CB3
	5	Ch3 D1	Ch3 D0	Ch3 D1	Ch3 D0
	6	reserved	SB4	reserved	CB4
	7	Ch4 D1	Ch4 D0	Ch4 D1	Ch4 D0

**Complete evaluation in Motorola format with word alignment**

	Address	Input data		Output data	
Conditions	Word offset	High byte	Low byte	High byte	Low byte
Complete evaluation: yes	0	reserved	SB1	reserved	CB1
Motorola format: yes	1	Ch1 D0	Ch1 D1	Ch1 D0	Ch1 D1
Word alignment: yes	2	reserved	SB2	reserved	CB2
	3	Ch2 D0	Ch2 D1	Ch2 D0	Ch2 D1
	4	reserved	SB3	reserved	CB3
	5	Ch3 D0	Ch3 D1	Ch3 D0	Ch3 D1
	6	reserved	SB4	reserved	CB4
	7	Ch4 D0	Ch4 D1	Ch4 D0	Ch4 D1

**Key**

Complete evaluation: In addition to the process data, the control and status bytes are also mapped into the address space.

Motorola format: Motorola or Intel format can be set.

Word alignment: In order for the channel address range to commence at a word boundary, empty bytes are inserted into the process image as appropriate.

SB n: Status byte for channel n (appears in the input process image).

CB n: Control byte for channel n (appears in the output process image).

Ch n D0: channel n, lower-value data byte

Ch n D1: channel n, higher-value data byte

reserved: This byte is assigned to the process data memory, although it has no function.

"-": This byte is not used or occupied by the terminal/module.

## 7.3 Control and Status Bytes

### Channel 1

#### Process data mode

#### Control byte 1 in process data mode

Control byte 1 (CB1) is located in the [output image \[► 34\]](#), and is transmitted from the controller to the terminal. In process data mode it has no function.

Bit	CB1.7	CB1.6	CB1.5	CB1.4	CB1.3	CB1.2	CB1.1	CB1.0
Name	RegAccess	-	-	-	-	-	-	-

**Key**

Bit	Name	Description
CB1.7	RegAccess	0 <sub>bin</sub> Register communication off (process data mode)
CB1.6 - CB1.0	-	0 <sub>bin</sub> reserved

#### Status byte 1 in process data mode

The status byte 1 (SB1) is located in the [input image \[► 34\]](#) and is transmitted from terminal to the controller.

Bit	SB1.7	SB1.6	SB1.5	SB1.4	SB1.3	SB1.2	SB1.1	SB1.0
Name	RegAccess	Error	LimitValue 2 State		LimitValue 1 State		Overrange	Under range

**Key**

Bit	Name	Description
SB1.7	RegAccess	0 <sub>bin</sub> Acknowledgment for process data mode
SB1.6	Error	1 <sub>bin</sub> General error bit
SB1.5 - SB1.4	LimitValue 2 State	00 <sub>bin</sub> Limit value 2 not enabled
		01 <sub>bin</sub> Process data less than limit value 2
		10 <sub>bin</sub> Process data greater than limit value 2
		11 <sub>bin</sub> Process data equal limit value 2
SB1.3 - SB1.2	LimitValue 1 State	00 <sub>bin</sub> Limit value 1 not enabled
		01 <sub>bin</sub> Process data less than limit value 1
		10 <sub>bin</sub> Process data greater than limit value 1
		11 <sub>bin</sub> Process data equal limit value 1
SB1.1	Overrange	1 <sub>bin</sub> Permissible measuring range exceeded
SB1.0	Under range	1 <sub>bin</sub> Lower measuring range limit violated

**Register communication****Control byte 1 in register communication**

Control byte 1 (CB1) is located in the output image [► 34], and is transmitted from the controller to the terminal.

Bit	CB1.7	CB1.6	CB1.5	CB1.4	CB1.3	CB1.2	CB1.1	CB1.0
Name	RegAccess	R/W	Reg. no.					

**Key**

Bit	Name	Description
CB1.7	RegAccess	1 <sub>bin</sub> Register communication switched on
CB1.6	R/W	0 <sub>bin</sub> Read access
		1 <sub>bin</sub> Write access
CB1.5 to CB1.0	Reg. no.	Register number: Enter here the number of the register that you wish - to read with input data word <u>DataIN1</u> [► 34], or - to write with output data word <u>DataOUT1</u> [► 34].

**Status byte 1 in register communication**

The status byte 1 (SB1) is located in the input image [► 34] and is transmitted from terminal to the controller.

Bit	SB1.7	SB1.6	SB1.5	SB1.4	SB1.3	SB1.2	SB1.1	SB1.0
Name	RegAccess	R/W	Reg. no.					

**Key**

Bit	Name	Description
SB1.7	RegAccess	1 <sub>bin</sub> Acknowledgment for register access
SB1.6	R	0 <sub>bin</sub> Read access
SB1.5 to SB1.0	Reg. no.	Number of the register that was read or written.

**Channel 2, channel 3 and channel 4**

The control and status bytes of channels 2, 3 and 4 are structured like the control and status byte of channel 1.

## 7.4 Register Overview

The following registers are used to parameterize the KL3404, KL3408, KL3464 and KL3468. Each signal channel of the analog terminal has one register that can be read or written to with the aid of control [► 38], status [► 38] and data bytes [► 35] via register communication [► 38].

Register no.	Comment	Default value		R/W	Memory	
R0 [► 40]	Raw value of the A/D converter ( $X_R$ )	-	-	R	RAM	
R1	reserved	-	-	-	-	
...	...	...	...	...	...	
R5	reserved	-	-	-	-	
R6 [► 40]	Diagnostic register	-	-	R	RAM	
R7 [► 40]	Command register	0x0000	0 <sub>dec</sub>	R/W	RAM	
R8 [► 40]	Terminal type	KL3404: KL3408: KL3464: KL3468:	0x0D4C 0x0D50 0x0D88 0x0D8C	3404 <sub>dec</sub> 3408 <sub>dec</sub> 3464 <sub>dec</sub> 3468 <sub>dec</sub>	R	ROM
R9 [► 40]	Firmware version	e.g. 0x3141	e.g. 1A <sub>ASCII</sub>	R	ROM	
R10 [► 40]	Data length (multiplex shift register)	0x0230	560 <sub>dec</sub>	R	ROM	
R11 [► 40]	Signal channels	0x0418	1048 <sub>dec</sub>	R	ROM	
R12 [► 40]	Minimum data length	0x0098	152 <sub>dec</sub>	R	ROM	
R13 [► 41]	Data structure (data type register)	0x0004	4 <sub>dec</sub>	R	ROM	
R14	reserved	-	-	-	-	
R15 [► 41]	Alignment register	e.g. 0x7F80	e.g. 32640 <sub>dec</sub>	R/W	RAM	
R16 [► 41]	Hardware version number	e.g. 0x0000	e.g. 0 <sub>dec</sub>	R/W	SEEPROM	
R17 [► 41]	Hardware compensation: Offset ( $B_a$ )	0x0000	0 <sub>dec</sub>	R/W	SEEPROM	
R18 [► 41]	Hardware compensation: Gain ( $A_a$ )	KL3404: KL3408: KL3464: KL3468:	approx. 0x135A approx. 0x13A6	approx. 4954 <sub>dec</sub> approx. 5030 <sub>dec</sub>	R/W	SEEPROM
R19 [► 41]	Manufacturer scaling: Offset ( $B_n$ )	0x0000	0 <sub>dec</sub>	R/W	SEEPROM	
R20 [► 41]	Manufacturer scaling: Gain ( $A_n$ )	typ. 0x2000	typ. 8192 <sub>dec</sub>	R/W	SEEPROM	
R21 [► 41]	Overrange limit	KL3404: KL3408: KL3464: KL3468:	0x07FF 0x0FFF	2047 <sub>dec</sub> 4095 <sub>dec</sub>	R/W	SEEPROM
R22 [► 42]	Under range limit	KL3404: KL3408: KL3464: KL3468:	0xF800 0x0000	63488 <sub>dec</sub> 0 <sub>dec</sub>	R/W	SEEPROM
R23	reserved	-	-	-	-	
...	...	...	...	...	...	
R30	reserved	-	-	-	-	
R31 [► 42]	Code word register	0x0000	0 <sub>dec</sub>	R/W	RAM	
R32 [► 42]	Feature register	0x0906	2310 <sub>dec</sub>	R/W	SEEPROM	
R33 [► 44]	User scaling: Offset ( $B_w$ )	0x0000	0 <sub>dec</sub>	R/W	SEEPROM	
R34 [► 44]	User scaling: Gain ( $A_w$ )	0x0400	1024 <sub>dec</sub>	R/W	SEEPROM	
R35 [► 44]	Threshold 1 in ( $Y_2$ )	0x0000	0 <sub>dec</sub>	R/W	SEEPROM	
R36 [► 44]	Threshold 2 in ( $Y_2$ )	0x0000	0 <sub>dec</sub>	R/W	SEEPROM	
R37 [► 44]	Cut-off frequency of the digital IIR filter	0x0100	256 <sub>dec</sub>	R/W	SEEPROM	
R38	reserved	-	-	-	-	
...	reserved	...	...	...	...	
R63	reserved	-	-	-	-	

## 7.5 Register description

The following registers are used to parameterize the KL3404, KL3408, KL3464 and KL3468. Each signal channel of the analog terminal has one register that can be read or written to with the aid of [control \[► 38\]](#), [status \[► 38\]](#) and [data bytes \[► 35\]](#) via [register communication \[► 38\]](#).

### R0 Raw value A/D-C

Raw value of the A/D converter ( $X_R$ )

### R6: Diagnostic register

The [status byte \[► 37\]](#) is mapped to the low-order byte (bit 7 to bit 0) of register R6. The high-order byte (bit 15 to bit 8) of register R6 is reserved.

### R7: Command register

The command register of KL3404 and KL3464 is currently not used.

### R8: Terminal description

Register R8 contains the terminal identifier. e.g.:

- KL3404: 0x0D4C (3404<sub>dec</sub>) or
- KL3464: 0x0D88 (3464<sub>dec</sub>)

### R9 Firmware version

Register R9 contains the ASCII coding of the terminal's firmware version, e.g. **0x3141 (1A)<sub>ASCII</sub>**. **'0x31'** corresponds to the ASCII character **'1'** and **'0x41'** to the ASCII character **'A'**. This value cannot be changed.

### R10: Data length (multiplex shift register)

R10 contains the number of multiplexed shift registers and their length in bits.

### R11: Signal channels

Unlike R10, this contains the number of channels that are logically present. Thus for example a shift register that is physically present can perfectly well consist of several signal channels.

### R12: Minimum data length

The particular byte contains the minimum data length for a channel that is to be transferred. If the MSB is set, the control and status byte is not necessarily required for the terminal function and is not transferred to the control, if the Bus Coupler is configured accordingly.



**R13: Data structure (data type register)**

Data type register	Meaning
0x00	Terminal with no valid data type
0x01	Byte array
0x02	Structure: 1 byte, n bytes
0x03	Word array
0x04	Structure: 1 byte, n words
0x05	Double word array
0x06	Structure: 1 byte, n double words
0x07	Structure: 1 byte, 1 double word
0x08	Structure: 1 byte, 1 double word
0x11	Byte array with variable logical channel length
0x12	Structure: 1 byte, n bytes with variable logical channel length (e.g. 60xx)
0x13	Word array with variable logical channel length
0x14	Structure: 1 byte, n words with variable logical channel length
0x15	Double word array with variable logical channel length
0x16	Structure: 1 byte, n double words with variable logical channel length

**R15: Alignment register**

Via the alignment register bits, the Bus Coupler arranges the address range of an analog terminal such that it starts at a byte boundary.

**R16: Hardware version number**

Register R16 contains the hardware version of the terminal; this value cannot be changed.

**R17: Hardware compensation - offset (B<sub>a</sub>)**

This register is used for the offset compensation of the terminal (see equation 1.1). Register value (16 bit signed integer) 0x0000 (0<sub>dec</sub>)

**R18: Hardware compensation - gain (A<sub>a</sub>)**

This register is used for the gain compensation of the terminal (see equation 1.1). Register value (16 bit signed integer x 2<sup>-12</sup>):

- KL3404: approx. 0x135A (4954<sub>dec</sub>)
- KL3464: approx. 0x13A6 (5030<sub>dec</sub>)

**R19: Manufacturer scaling - offset (B<sub>n</sub>)**

This register contains the offset for the manufacturer scaling (see equation 1.3). Register value (16 bit signed integer) 0x0000 (0<sub>dec</sub>)

Manufacturer scaling can be enabled via bit [R32.1](#) [[▶ 42](#)] of the feature register.

**R20: Manufacturer scaling - gain (A<sub>n</sub>)**

This register contains the gain for manufacturer scaling (see equation 1.3). Register value (16 bit signed integer x 2<sup>-10</sup>): typically 0x2000 (8192<sub>dec</sub>)

Manufacturer scaling can be enabled via bit [R32.1](#) [[▶ 42](#)] of the feature register.

**R21 over-range limit - OvRL (Y<sub>a</sub>)**

This limit value limits the maximum measuring range of the input terminal (see equation 1.0). If it is exceeded, the associated status bit is set, and the maximum value is displayed. Register value (16 bit signed integer)

- KL3404: 0x07FF (2047<sub>dec</sub>)
- KL3464: 0x0FFF (4095<sub>dec</sub>)

**R22 under-range limit - UnRL ( $Y_a$ )**

If the value falls below this limit, the associated status bit is set, and the minimum value is displayed (see equation 1.0). Register value (16 bit signed integer)

- KL3404: 0xF800 (63488<sub>dec</sub>)
- KL3464: 0x0000 (0<sub>dec</sub>)

**R31: Code word register**

- If you write values into the user registers without first entering the user code word (0x1235) into the code word register, the terminal will not accept the supplied data.
- If you write values into the user registers and have previously entered the user code word (0x1235) in the code word register, these values are stored in the RAM registers and in the SEEPROM registers and are therefore retained if the terminal is restarted.

The code word is reset with each restart of the terminal.

**R32 Feature register**

The feature register specifies the terminal's configuration. Default: 0x0906 (2310<sub>dec</sub>)

Bit	R32.15	R32.14	R32.13	R32.12	R32.11	R32.10	R32.9	R32.8
Name	-	-	-	-	enIIR	enLimit2	enLimit1	enOvRP

Bit	R32.7	R32.6	R32.5	R32.4	R32.3	R32.2	R32.1	R32.0
Name	-	-	-	enSiemens	enSignRepr	enWdTimer	enManScal	enUsrScal

**Key**

Bit	Name	Description	Default
R32.15	-	reserved	0 <sub>bin</sub>
...	...	...	...
R32.12	-	reserved	0 <sub>bin</sub>
R32.11	enIIR	0 <sub>bin</sub> digital IIR filter inactive	1 <sub>bin</sub>
		1 <sub>bin</sub> digital IIR filter active	
R32.10	enLimit2	0 <sub>bin</sub> Limit value 2 is not active	0 <sub>bin</sub>
		1 <sub>bin</sub> Limit value 2 is active	
R32.9	enLimit1	0 <sub>bin</sub> Limit value 1 is not active	0 <sub>bin</sub>
		1 <sub>bin</sub> Limit value 1 is active	
R32.8	enOvRP	0 <sub>bin</sub> Over-range protection is not active	1 <sub>bin</sub>
		1 <sub>bin</sub> Over-range protection is active: If the limit values of registers OvRL (R21) and UnRL (R22) are exceeded, the associated status bits are set and the measuring range is restricted accordingly.	
R32.7	-	reserved	0 <sub>bin</sub>
R32.6	-	reserved	0 <sub>bin</sub>
R32.5	-	reserved	0 <sub>bin</sub>
R32.4	enSiemens	0 <sub>bin</sub> Standard output format	0
		1 <sub>bin</sub> Siemens output format The three bits with the lowest value are used for displaying status information (see below).	
R32.3	enSignRepr	0 <sub>bin</sub> Two's complement representation is active	0 <sub>bin</sub>
		1 <sub>bin</sub> Signed amount representation is active (-1 <sub>dec</sub> = 0x8001)	
R32.2	enWdTimer	0 <sub>bin</sub> Watchdog timer is not active	1 <sub>bin</sub>
		1 <sub>bin</sub> Watchdog timer is active (the watchdog is triggered if no process data are received for 100 ms)	
R32.1	enManScal	0 <sub>bin</sub> Manufacturer scaling is active	1 <sub>bin</sub>
		1 <sub>bin</sub> Manufacturer scaling is not active	
R32.0	enUsrScal	0 <sub>bin</sub> User scaling is not active	0 <sub>bin</sub>
		1 <sub>bin</sub> User scaling is active	

**Siemens output format**

If the Siemens output format is selected, the lowest three bits are used for status evaluation. The process data is represented in bits 15 to 3, with bit 15 representing the sign bit. Scaling of the measured value according to the Siemens standard has to be done via user scaling (R33, R34).

**KL3404**

Measured value	Bit 15 ... 3	Bit 2 X	Bit 1 Error	Bit 0 Overflow
Measured value < 10 V	Process data	0	0	0
Measured value > 10 V		0	0	1

**KL3464**

Measured value	Bit 15 ... 3	Bit 2 X	Bit 1 Error	Bit 0 Overflow
Measured value < -10 V		0	0	1
-10 V < Measured value < 10 V	Process data	0	0	0
Measured value >+10 V		0	0	1

**R33 User scaling - offset ( $B_w$ )**

This register contains the offset of the user scaling.

User scaling can be enabled in the feature register via bit [R32.0](#) [▶ 42].

**R34 User scaling - gain ( $A_w$ )**

This register contains the user scaling gain;  $0x0400$  ( $1024_{dec}$ ) corresponds to 1.

User scaling can be enabled in the feature register via bit [R32.0](#) [▶ 42].

**R35 Threshold 1 in  $Y_2$** 

If the process data are outside this threshold, the appropriate bits are set in the status byte.

**R36 Threshold 2 in  $Y_2$** 

If the process data are outside this threshold, the appropriate bits are set in the status byte.

**R37 Cut-off frequency of the digital IIR filter**

This register determines the cut-off frequency of the digital IIR filter (first order). The IIR filter can be disabled in the feature register with bit [R32.11](#) [▶ 42].

Value	Limit frequency	
	KL3404, KL3464	KL3408, KL3468:
0x0100 (default)	approx. 200 Hz	approx. 100 Hz
0x0200	approx. 100 Hz	approx. 50 Hz
0x0300	approx. 50 Hz	approx. 25 Hz
0x0400	approx. 20 Hz	approx. 10 Hz
other	No filter active	

## 7.6 Examples of Register Communication

The numbering of the bytes in the examples corresponds to the display without word alignment.

### 7.6.1 Example 1: reading the firmware version from Register 9

#### Output Data

Byte 0: Control byte	Byte 1: DataOUT1, high byte	Byte 2: DataOUT1, low byte
0x89 (1000 1001 <sub>bin</sub> )	0xXX	0xXX

Explanation:

- Bit 0.7 set means: Register communication switched on.
- Bit 0.6 not set means: reading the register.
- Bits 0.5 to 0.0 specify the register number 9 with 00 1001<sub>bin</sub>.
- The output data word (byte 1 and byte 2) has no meaning during read access. To change a register, write the required value into the output word.

#### Input Data (answer of the bus terminal)

Byte 0: Status byte	Byte 1: DataIN1, high byte	Byte 2: DataIN1, low byte
0x89	0x33	0x41

Explanation:

- The terminal returns the value of the control byte as a receipt in the status byte.
- The terminal returns the firmware version 0x3341 in the input data word (byte 1 and byte 2). This is to be interpreted as an ASCII code:
  - ASCII code 0x33 represents the digit 3
  - ASCII code 0x41 represents the letter A
 The firmware version is thus 3A.

### 7.6.2 Example 2: Writing to an user register



**Note**

#### Code word

In normal mode all user registers are read-only with the exception of Register 31. In order to deactivate this write protection you must write the code word (0x1235) into Register 31. If a value other than 0x1235 is written into Register 31, write protection is reactivated. Please note that changes to a register only become effective after restarting the terminal (power-off/power-on).

#### I. Write the code word (0x1235) into Register 31.

#### Output Data

Byte 0: Control byte	Byte 1: DataOUT1, high byte	Byte 2: DataOUT1, low byte
0xDF (1101 1111 <sub>bin</sub> )	0x12	0x35

Explanation:

- Bit 0.7 set means: Register communication switched on.
- Bit 0.6 set means: writing to the register.
- Bits 0.5 to 0.0 specify the register number 31 with 01 1111<sub>bin</sub>.
- The output data word (byte 1 and byte 2) contains the code word (0x1235) for deactivating write protection.

**Input Data (answer of the bus terminal)**

Byte 0: Status byte	Byte 1: DataIN1, high byte	Byte 2: DataIN1, low byte
0x9F (1001 1111 <sub>bin</sub> )	0xXX	0xXX

Explanation:

- The terminal returns a value as a receipt in the status byte that differs only in bit 0.6 from the value of the control byte.
- The input data word (byte 1 and byte 2) is of no importance after the write access. Any values still displayed are invalid!

**II. Read Register 31 (check the set code word)****Output Data**

Byte 0: Control byte	Byte 1: DataOUT1, high byte	Byte 2: DataOUT1, low byte
0x9F (1001 1111 <sub>bin</sub> )	0xXX	0xXX

Explanation:

- Bit 0.7 set means: Register communication switched on.
- Bit 0.6 not set means: reading the register.
- Bits 0.5 to 0.0 specify the register number 31 with 01 1111<sub>bin</sub>.
- The output data word (byte 1 and byte 2) has no meaning during read access.

**Input Data (answer of the bus terminal)**

Byte 0: Status byte	Byte 1: DataIN1, high byte	Byte 2: DataIN1, low byte
0x9F (1001 1111 <sub>bin</sub> )	0x12	0x35

Explanation:

- The terminal returns the value of the control byte as a receipt in the status byte.
- The terminal returns the current value of the code word register in the input data word (byte 1 and byte 2).

**III. Write to Register 32 (change contents of the feature register)****Output data**

Byte 0: Control byte	Byte 1: DataIN1, high byte	Byte 2: DataIN1, low byte
0xE0 (1110 0000 <sub>bin</sub> )	0x00	0x02

Explanation:

- Bit 0.7 set means: Register communication switched on.
- Bit 0.6 set means: writing to the register.
- Bits 0.5 to 0.0 indicate register number 32 with 10 0000<sub>bin</sub>.
- The output data word (byte 1 and byte 2) contains the new value for the feature register.

**Observe the register description!**

The value of 0x0002 given here is just an example!  
The bits of the feature register change the properties of the terminal and have a different meaning, depending on the type of terminal. Refer to the description of the feature register of your terminal (chapter *Register description*) regarding the meaning of the individual bits before changing the values.

**Input data (response from the Bus Terminal)**

Byte 0: Status byte	Byte 1: DataIN1, high byte	Byte 2: DataIN1, low byte
0xA0 (1010 0000 <sub>bin</sub> )	0xXX	0xXX

Explanation:

- The terminal returns a value as a receipt in the status byte that differs only in bit 0.6 from the value of the control byte.
- The input data word (byte 1 and byte 2) is of no importance after the write access. Any values still displayed are invalid!

**IV. Read Register 32 (check changed feature register)**

**Output Data**

Byte 0: Control byte	Byte 1: DataOUT1, high byte	Byte 2: DataOUT1, low byte
0xA0 (1010 0000 <sub>bin</sub> )	0xXX	0xXX

Explanation:

- Bit 0.7 set means: Register communication switched on.
- Bit 0.6 not set means: reading the register.
- Bits 0.5 to 0.0 indicate register number 32 with 10 0000<sub>bin</sub>.
- The output data word (byte 1 and byte 2) has no meaning during read access.

**Input Data (answer of the bus terminal)**

Byte 0: Status byte	Byte 1: DataIN1, high byte	Byte 2: DataIN1, low byte
0xA0 (1010 0000 <sub>bin</sub> )	0x00	0x02

Explanation:

- The terminal returns the value of the control byte as a receipt in the status byte.
- The terminal returns the current value of the feature register in the input data word (byte 1 and byte 2).

**V. Write Register 31 (reset code word)**

**Output Data**

Byte 0: Control byte	Byte 1: DataOUT1, high byte	Byte 2: DataOUT1, low byte
0xDF (1101 1111 <sub>bin</sub> )	0x00	0x00

Explanation:

- Bit 0.7 set means: Register communication switched on.
- Bit 0.6 set means: writing to the register.
- Bits 0.5 to 0.0 specify the register number 31 with 01 1111<sub>bin</sub>.
- The output data word (byte 1 and byte 2) contains 0x0000 for reactivating write protection.

**Input Data (answer of the bus terminal)**

Byte 0: Status byte	Byte 1: DataIN1, high byte	Byte 2: DataIN1, low byte
0x9F (1001 1111 <sub>bin</sub> )	0xXX	0xXX

Explanation:

- The terminal returns a value as a receipt in the status byte that differs only in bit 0.6 from the value of the control byte.
- The input data word (byte 1 and byte 2) is of no importance after the write access. Any values still displayed are invalid!

## 8 Appendix

### 8.1 Support and Service

Beckhoff and their partners around the world offer comprehensive support and service, making available fast and competent assistance with all questions related to Beckhoff products and system solutions.

#### **Beckhoff's branch offices and representatives**

Please contact your Beckhoff branch office or representative for [local support and service](#) on Beckhoff products!

The addresses of Beckhoff's branch offices and representatives round the world can be found on her internet pages:

<http://www.beckhoff.com>

You will also find further [documentation](#) for Beckhoff components there.

#### **Beckhoff Headquarters**

Beckhoff Automation GmbH & Co. KG

Huelshorstweg 20  
33415 Verl  
Germany

Phone:	+49(0)5246/963-0
Fax:	+49(0)5246/963-198
e-mail:	info@beckhoff.com

#### **Beckhoff Support**

Support offers you comprehensive technical assistance, helping you not only with the application of individual Beckhoff products, but also with other, wide-ranging services:

- support
- design, programming and commissioning of complex automation systems
- and extensive training program for Beckhoff system components

Hotline:	+49(0)5246/963-157
Fax:	+49(0)5246/963-9157
e-mail:	support@beckhoff.com

#### **Beckhoff Service**

The Beckhoff Service Center supports you in all matters of after-sales service:

- on-site service
- repair service
- spare parts service
- hotline service

Hotline:	+49(0)5246/963-460
Fax:	+49(0)5246/963-479
e-mail:	service@beckhoff.com



# List of illustrations

Fig. 1	KL3404, KL3464 .....	8
Fig. 2	LEDs .....	10
Fig. 3	KL3408 and KL3468 .....	11
Fig. 4	LEDs .....	13
Fig. 5	Signal processing .....	15
Fig. 6	Signal processing .....	16
Fig. 7	Attaching on mounting rail .....	17
Fig. 8	Disassembling of terminal .....	18
Fig. 9	Power contact on left side .....	19
Fig. 10	Standard wiring .....	20
Fig. 11	Pluggable wiring .....	21
Fig. 12	High Density Terminals .....	21
Fig. 13	Connecting a cable on a terminal point .....	22
Fig. 14	Connection KL3404 and KL3464 .....	23
Fig. 15	Connection KL3408 and KL3468 .....	24
Fig. 16	KS2000 configuration software .....	28
Fig. 17	Display of the fieldbus station in KS2000 .....	30
Fig. 18	KS2000 tree branch for channel 1 of the KL3404 .....	31
Fig. 19	Settings via KS2000 .....	31
Fig. 20	Register view in KS2000 .....	33