



Startup

Servo Drive AX5000

(1.5 A – 40 A)

Please read this document carefully before installing and commissioning the servo drive.

Version: 5.9
Date: 2018-05-24
Language: English
Article no.: TDmIAX-5000-0000-0200



BECKHOFF

Notes:

Chapter	Page
Table of contents – AX5000 Startup	
1	Foreword.....5
1.1	Notes on the documentation.....5
1.2	Disclaimer.....5
1.3	Trademarks5
1.4	Patent Pending.....5
1.5	Copyright.....6
1.6	Documentation issue status6
1.7	Appropriate use.....7
1.7.1	Dual Use (EU 1384/2014)8
1.8	Documented servo drives.....8
2	For your safety9
2.1	Staff qualification9
2.2	Description of symbols10
2.3	Notes for the servo drive AX5000.....11
3	Guidelines and Standards.....13
3.1	CE conformity13
3.2	Electromagnetic compatibility13
3.3	RoHS requirements.....13
3.3	UL-Listing in USA and Canada.....14
3.3.1	UL-specific chapter changes14
3.3.2	UL-specific chapter.....14
3.3.3	UL-specific notes15
3.4	Electrical isolation according to EN 50178 / VDE 16015
4	Product description16
4.1	Type code.....16
4.2	Scope of supply.....16
4.2.1	Standard scope of supply16
4.2.2	Accessories17
4.3	Name plate17
4.4	Technical data17
4.4.1	Permissible ambient and operating conditions18
4.4.2	Electrical data - single-channel servo drive (AX51xx).....18
4.4.3	Electrical data - two-channel servo drive (AX52xx)20
4.4.4	Mechanical data (single-channel servo drive)21
4.4.5	Mechanical data (two-channel servo drive)21
4.5	General overview (AX5101 – AX5112 and AX520x)22
4.6	General overview (AX5118, AX5125 und AX5140)22
4.7	Overview of connectors/terminal points.....24
4.7.1	X01 - wide voltage input.....24
4.7.2	X02 - DC link (AX5101 - AX5125 und AX520x).....24
4.7.3	X02 - DC link (Only AX5140).....24
4.7.4	X03 - 24 V _{DC} supply.....24
4.7.5	X04, X05 - EtherCAT connection25
4.7.6	X06 – Digital I/Os25

4.7.7	X11 (channel A) , X21 (channel B) - feedback, high-resolution.....	26
4.7.8	X12 (channel A) , X22 (channel B) - resolver/hall	26
4.7.9	X13 (channel A) , X23 (channel B) - motor connection (power)	27
4.7.10	X13 - motor connection (power - only AX5140).....	27
4.7.11	X14 (channel A), X24 (channel B)-motor brake, thermal contact, OCT.....	27
4.7.12	X07 – internal and external brake resistor.....	28
4.8	Dimensions	29
5	Installation.....	31
5.1	Mechanical installation	31
5.1.1	Installation in the control cabinet	31
5.1.1.1	Installation example - AX5101-AX5112 and AX5201-AX5206	32
5.1.1.2	Installation example - AX5118, AX5125 and AX5140	32
5.2	Electrical installation.....	33
5.2.1	Mains supply connection (X01)	34
5.2.2	24 V _{DC} - supply network connection (X03)	37
5.2.3	Connection of several servo drives to form a drive system	37
5.2.4	UL-Bridge, configuration example	40
5.2.5	Connection diagram AX5101 – AX5112 and AX520x	41
5.2.6	Connection diagram AX5118, AX5125 and AX5140.....	42
5.3	Motors and cables.....	43
6	Important information for commissioning.....	44
7	Project planning – important information.....	45
7.1	Drive train design	45
7.1.1	Control quality, mass inertia ratio and load connection	45
7.2	Energy management.....	45
7.3	EMC, earthing, screen connection and potential.....	46
7.4	Control cabinet.....	46
8	Appendix	47
8.1	Support and Service.....	47
8.1.1	Beckhoff's branch offices and representatives	47
8.1.2	Beckhoff Headquarters.....	47
8.1.3	Beckhoff Support.....	47
8.1.4	Beckhoff Service	47

1 Foreword

1.1 Notes on the documentation

This description is only intended for trained specialists in control, automation and drive engineering who are familiar with the applicable national standards. It is essential that the following notes and explanations are followed when installing and commissioning these components. It is the duty of the technical personnel to use the documentation published at the respective time of each installation and commissioning. The responsible staff must ensure that the application or use of the products described satisfy all the requirements for safety, including all the relevant laws, regulations, guidelines and standards. The "General safety instructions" and "Special safety instructions for AX5000" sections are also essential.

 <p>CAUTION</p>	<p>Hazard to individuals!</p> <p>Further and more detailed information regarding the individual sections and safety can be found in the "AX5000 System manual" that can be downloaded from our website at www.beckhoff.com. If you do not have access to the "AX5000 System manual" please refrain from working on the AX5000 and notify our support division.</p>
--	---

An overview is provided on the inside of the rear cover, which can be folded out.

1.2 Disclaimer

The documentation has been prepared with care. The products described are, however, constantly under development. We reserve the right to revise and change the documentation at any time and without prior announcement. No claims for the modification of products that have already been supplied may be made on the basis of the data, diagrams and descriptions in this documentation.

1.3 Trademarks

Beckhoff®, TwinCAT®, EtherCAT®, Safety over EtherCAT®, TwinSAFE® and XFC® are registered trademarks of and licensed by Beckhoff Automation GmbH.

Other designations used in this publication may be trademarks whose use by third parties for their own purposes could violate the rights of the owners.

1.4 Patent Pending

The EtherCAT Technology is covered, including but not limited to the following patent applications and patents:

EP1590927, EP1789857, DE102004044764, DE102007017835

with corresponding applications or registrations in various other countries.

The TwinCAT Technology is covered, including but not limited to the following patent applications and patents:

EP0851348, US6167425 with corresponding applications or registrations in various other countries.

1.5 Copyright

© Beckhoff Automation GmbH & Co. KG

The reproduction, distribution and utilization of this document as well as the communication of its contents to others without express authorization are prohibited.

Offenders will be held liable for the payment of damages. All rights reserved in the event of the grant of a patent, utility model or design.

1.6 Documentation issue status

Version	Comment
5.9	Chapter update: Dual Use 1.7.1 ; Installation in the control cabinet 5.1.1
5.8	Chapter update: Permissible ambient and operating conditions 4.4.1
5.7	Chapter update: Appropriate use 1.7 ; For your safety 2 ; Guidelines and Standards 3 ; Electrical data 4.4.3.2 ; Motors and cables 5.3 ; New chapter: RoHS requirements 3.3 Further update: The DVD has been replaced by a QR code on the cover.
5.6	Chapter update: Name plate 4.3 ; Permissible ambient and operating conditions 4.4.1
5.5	Chapter update: 4.5;4.6
5.4	Chapter update: 1.1; 1.2; 4.4.2.2
5.3	Chapter update: 1.7.1
5.2	Chapter update: 1.1; 4.4.3.2; 4.4.6; 4.5; 4.6; 4.7.3; 4.7.4; 4.7.9; 4.8; 5.1.1.1; 5.1.1.2; 5.2.3.1; 5.2.3.2; 6
5.1	Chapter update: 3.3.3; 5.2.4
5.0	Chapter update: 4.4.2; 4.4.3; 4.5; 4.6; 4.7.3; 4.7.12; 5.2.3.2
4.9	Chapter update: 2.2; 4.4.2.1; 4.4.2.2; 4.4.3.1; 4.4.3.2; 4.7.3; 4.7.7; 4.7.12
4.8	Chapter update: 4.7.7
4.7	Chapter update: 4.4.2.1; 4.4.2.2; 4.4.3.1; 4.4.3.2; 4.7.9; 4.7.11; 7
4.6	Chapter update: 3.3.1; 3.3.2; 4.1; 4.3; 4.8; 5.1.1; 5.1.1.2; 5.2.1.3; 5.2.1.5; 5.2.3; 5.2.4; 7.1.1
4.5	New chapter: 5.2.5; 5.2.6

	Chapter update: 4.7.11; 5.2.1.1
4.4	Chapter update: 4.4.2; 4.4.3
4.3	New chapter: 1.7.1 Chapter update: 1.5; 2.1.2; 4.3; 5.3; 8.1.2
4.2	Deleted chapter: 7.5 New chapter: 5.3
4.1	General revision
4.0	General revision on account of the cULus-Listing of the AX5000.

1.7 Appropriate use

The servo drives of the AX5000 series are **exclusively** designed for torque, speed and position control of suitable asynchronous and synchronous three-phase current motors. The maximum permissible effective motor voltage must be at least equal the effective mains voltage fed into the servo drive.

The servo drives from the AX5000 series are designed for installation as components in electrical systems or machines and may be operated only as integrated system or machine components.

 WARNING	<p>Caution – Risk of injury!</p> <p>Electronic equipment is not fail-safe. The machine manufacturer is responsible for ensuring that the connected motors and the machine are brought into a safe state in the event of a fault in the drive system.</p>
--	---

The servo drives may **only** be operated in enclosed control cabinets and in accordance with the conditions described in the: "**Technical data**" section.

Improper use

The servo drive AX5000 is **not** suitable for use in the following areas:

- in ATEX zones without a suitable housing
- in areas with aggressive environments (e.g. aggressive gases or chemicals)

The relevant standards and directives for EMC interference emissions must be complied with in residential areas.

1.7.1 Dual Use (EU 1384/2014)

As published on December 30, 2014 by EU Commission Delegated Regulation 1382/2014, standard frequency inverters – and with that also Beckhoff products AX5000 – become newly classified Dual-Use items: the item list Annex I of the Dual-Use Council Regulation 428/2009 has been changed accordingly, Frequency inverters (listed in item position 3A225) with „operating frequency of 600 Hz or more“ are now export controlled items. As a consequence some modifications have to be noticed.

Firmware versions without extension (Dual Use conform) can be used in consideration of Hardware Versions with following drives:

- HW Version 1.0 (AX5xxx-0000-x0xx): Serial Number < 68.000
- HW Version 1.0 (AX5xxx-0000-x01x)
- HW Version 2.0 (AX5xxx-0000-x2xx): Serial Number < 140.000
- HW Version 2.0 (AX5xxx-0000-x21x)

Firmware versions with extension (Dual Use conform) can be used in consideration of Hardware Versions with all drives.

Example: Exchange of an old Hardware 1.0 device

The defect servo drive AX5203-0000-x0xx should be replaced with an AX5203-0000-x01x to avoid changes in the TC System Manager. When downgrading, the desired Firmware (FW v1.00 - FW v1.05) must also be requested from Beckhoff Automation GmbH & Co. KG.

1.8 Documented servo drives

This documentation describes the following servo drives in the AX5000 range:

AX5101	AX5103	AX5106	AX5112	AX5118
AX5125	AX5140	AX5201	AX5203	AX5206

2 For your safety

Read the section on safety and heed the notices to protect yourself against personal injury and material damages.

Liability limitations

All the components of the servo drive AX5000 are supplied in certain hardware and software configurations appropriate for the conditions of the application. Unauthorized modifications to the hardware and/or software configurations other than those described in the documentation are not permitted, and nullify the liability of Beckhoff Automation GmbH & Co. KG.

In addition, the following actions are excluded from the liability of Beckhoff Automation GmbH & Co. KG:

- Failure to comply with this documentation
- Improper use
- Untrained personnel
- Use of unauthorized spare parts

2.1 Staff qualification

Only technical personnel with knowledge of control and automation technology may carry out any of the illustrated work steps on the Beckhoff software and hardware, in particular on the servo drive AX5000.

The technical personnel must have knowledge of drive technology and electrical systems and must also know how to work safely on electrical equipment and machines.

This also includes:



- work preparation and
- Securing of the working environment
(e.g. securing the control cabinet against being switched on again).

The technical personnel must be familiar with the current and necessary standards and directives for the automation and drive environment.

2.2 Description of symbols

The following safety symbols with a adjoining safety advise are used in this manual. You have to read the adjoining safety advice carefully and adhere it strictly.



Symbols that warn of personal injury:

 <p>DANGER</p>	<p>Acute risk of injury!</p> <p>This is an extremely dangerous situation. Disregarding the safety notice will lead to serious permanent injuries or even death.</p>
 <p>WARNING</p>	<p>Risk of injury!</p> <p>This is a dangerous situation. Disregarding the safety notice may lead to serious injuries.</p>
 <p>CAUTION</p>	<p>Personal injuries!</p> <p>This is a dangerous situation. Disregarding the safety notice may lead to minor injuries.</p>

Symbols that warn of damage to property or equipment:

 <p>Attention</p>	<p>Warning of damage to property or the environment!</p> <p>This notice indicates disturbances in the operational procedure that could damage the product or the environment.</p>
---	--



Symbols indicating further information or tips:

 <p>Note</p>	<p>Tip or pointer!</p> <p>This symbol notice provides important information that will be of assistance in dealing with the product or software. There is no immediate danger to product, people or environment.</p>
	<p>UL pointer</p> <p>This symbol indicates important information about the UL-compliant.</p>

2.3 Notes for the servo drive AX5000

The safety instructions are designed to avert danger and must be followed during installation, commissioning, production, troubleshooting, maintenance and trial or test assemblies.

The servo drives of the AX5000 series are not designed for stand-alone operation and must always be installed in a machine or system. After installation the additional documentation and safety instructions provided by the machine manufacturer must be read and followed.

 <p>WARNING</p>	<p>Danger of life due to high voltage at the DC link capacitors of the servo drive AX5000!</p> <p>Due to the DC link capacitors dangerous voltage ($> 875 V_{DC}$) may persist at the DC link contacts “ZK+ and ZK- (DC+ and DC-)” and “RB+ and RB-” after the servo drive has been disconnected from the mains supply.</p> <p>Take the following measures for Safety:</p> <ul style="list-style-type: none"> • Wait at: <ul style="list-style-type: none"> ○ AX5101 – AX5125 and AX520x = 5 minutes ○ AX5140 = 15 minutes <p>after disconnected the servo drive from the mains supply. The device is safe once the voltage has fallen below 50 V.</p> • Measure the voltage at the DC link contacts. • Secure the work area and wear the PPE (personal protective equipment).
 <p>WARNING</p>	<p>Serious burns due to hot surfaces on the devices!</p> <p>The surface temperature of the devices can reach $\geq 50^{\circ}\text{C}$ during operation of the system. There is an acute risk of sustaining burns to parts of the body and limbs.</p> <p>Take the following measures to avert danger:</p> <ul style="list-style-type: none"> • Do not touch any components (housing, etc.) shortly after or during operation. • Wait until all components have cooled sufficiently. At least 15 minutes. • Check the surface temperature with a thermometer. • DO NOT wear work gloves with a rubber coating. These can fuse with the skin on account of the high temperature and cause serious injuries.

**NOTE****Notes on operation of the servo drive AX5000:**

- Carefully read this manual before using the servo drive thoroughly, paying particular attention to the safety instructions. In the event of any uncertainties please notify your sales office immediately and refrain from working on the servo drive.
- During the electrical installation it is essential to ensure that the correct fuses/protective circuit breakers are used between the mains supply and the servo drive.
Further information can be found in the "**Electrical installation**" section.
- If a servo drive is installed in a machine it must not be commissioned until proof of compliance of the machine with the latest version of the EC Machinery Directive has been provided. This includes all relevant harmonised standards and regulations required for implementation of this Directive in national legislation.

**Attention****Hazard to devices and environment**

- During installation it is essential to ensure that the specified ventilation clearances and climatic conditions are adhered to. Further information can be found in the "**Technical data**" and "**Mechanical installation**" sections.
- If the servo drive is operated in contaminated ambient air, the cooling openings must be checked regularly for blockage. These checks should be carried out several times per day.
- The servo drives contain components at risk from electrostatic discharge caused by improper handling:
 - Please ensure you are electrostatically discharged before touching the servo drive directly.
 - Avoid contact with highly insulating materials (synthetic fibres, plastic film etc.).
 - Place the servo drive on a conductive surface.
 - Do not touch the motor plug during operation of the AX5000.

3 Guidelines and Standards

3.1 CE conformity



NOTE

Supply of EC declaration of conformity:

Beckhoff Automation GmbH & Co. KG will gladly provide you with the certificates and manufacturer's declaration for all products on request at: info@beckhoff.com.



CAUTION

Hazard to individuals!

Servo drives are **not** covered by the EU Machinery Directive. Operation of the servo drives in machines or systems is only permitted once the machine or system manufacturers has provided evidence of CE conformity of the complete machine or system.

3.2 Electromagnetic compatibility

The servo drives of the AX5000 series comply with the

- 2004/108/EC EMC Directive (until 19/04/2016) and
- 2014/30/EU EMC Directive (from 20/04/2016)

Applied harmonised standards:

IEC / EN 61000-6-2:2005

(Interference immunity for the industrial areas)

IEC / EN 61000-6-4:2007+A1:2011

(Interference emission for the industrial areas)

3.3 RoHS requirements

The servo drives meet the requirements of RoHS Directive 2011/65/EU.

Applied harmonised standards:

RoHS : IEC / EN 50581:2012

(Technical documentation for the assessment of electrical and electronic products with respect to the restriction of hazardous substances).

3.3 UL-Listing in USA and Canada

The following servo drives from the AX5000 series have a UL-Listing and must bear the CUS symbol

	AX5000 with UL-Listing AX5101, AX5103, AX5106, AX5112, AX5118, AX5125, AX5140, AX5201, AX5203 und AX5206
--	--

on the name plate. If you wish to operate an AX5000 in USA or Canada, please check that there is a CUS symbol on the name plate.

Below is a list of the relevant chapters that are amended with respect to the UL-Listing. Furthermore, UL-specific remarks are listed. It is essential to observe these specifications.

3.3.1 UL-specific chapter changes

“5.2.1 Mains supply connection (X01)”

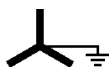

AX5000 shall be connected only to a **grounded wye-source** where the maximum voltage does not exceed 277 V to ground.

“5.2.3 Connection of several servo drives to form a drive system”

	Drive system with UL-Listing! Please note the configuration example in chapter 5.2.4
--	--

3.3.2 UL-specific chapter

“5.2.1.3 External protection, UL-compliant”

Integral solid state short circuit protection does not provide branch circuit protection. Branch circuit protection must be provided in accordance with the Manufacture Instructions, National Electrical Code and any additional local codes.

Suitable for use on a circuit capable of delivering not more than 18000 rms symmetrical amperes, 480 V maximum, when protected by RK5 class fuses.

For alternatives regarding class RK5 UL-fuses, you must observe “UL508 A, chapter SB4.2.3, exception no. 1”. For further questions regarding UL-fuses, please contact your responsible certification authority.

Single-phase

Fusing	AX5101	AX5103	AX5106	AX5201	AX5203	AX5206
AC supply (max.) *)	6 A	12 A	20 A	12 A	20 A	20 A
24 V supply (max.)	3 A					
Brake resistor	electronic					

*) UL-Mains fuses must be used

Three-phase

Fusing	AX									
	5101	5103	5106	5112	5118	5125	5140	5201	5203	5206
AC suppl (max.) ^{*)}	6 A	12 A	20 A	20 A	35 A	45 A	80 A	12 A	20 A	20 A
24 V supply (max.)	3 AT									
Brake resistor	elektronisch									

*) UL-Mains fuses must be used.

	<p>When protected by UL-fuses:</p>
	<p>AX5112 Rated 20 A, min. 480 V</p>
	<p>AX5118 Rated 35 A, min. 480 V</p>
	<p>AX5125 Rated 45 A, min. 480 V</p>
	<p>AX5140 Rated 80 A, min. 480 V</p>

3.3.3 UL-specific notes

Use in a Pollution Degree 2 environment

Use 75 °C Copper Conductors min.

Control Board rating = 24 V

Drive does not provide motor overtemperature protection.

Drive intended for use over a range of motor sizes. Internal motor overload protection level is adjustable (see "AX5000 function description → Thermal motor model").

	<p>Canada!</p>
	<p>In Canada use only in combination with unit AX2090-TS50, manufactured by Beckhoff Automation.</p>

3.4 Electrical isolation according to EN 50178 / VDE 160

The power section (motor connection, DC link connection and mains connection) and the control unit are **doubly** insulated against each other, so that safe protection against accidental contact is ensured at all terminals of the control unit without additional measures. The air and creepage distances also meet the requirements of the above standard.

4 Product description

The servo drives of the AX5000 series are available as single- or multi-channel versions and are optimised in terms of function and cost-effectiveness. In conjunction with EtherCAT, the real-time Ethernet system, the integrated control technology offers minimum cycle times and supports fast, highly dynamic positioning tasks.

4.1 Type code

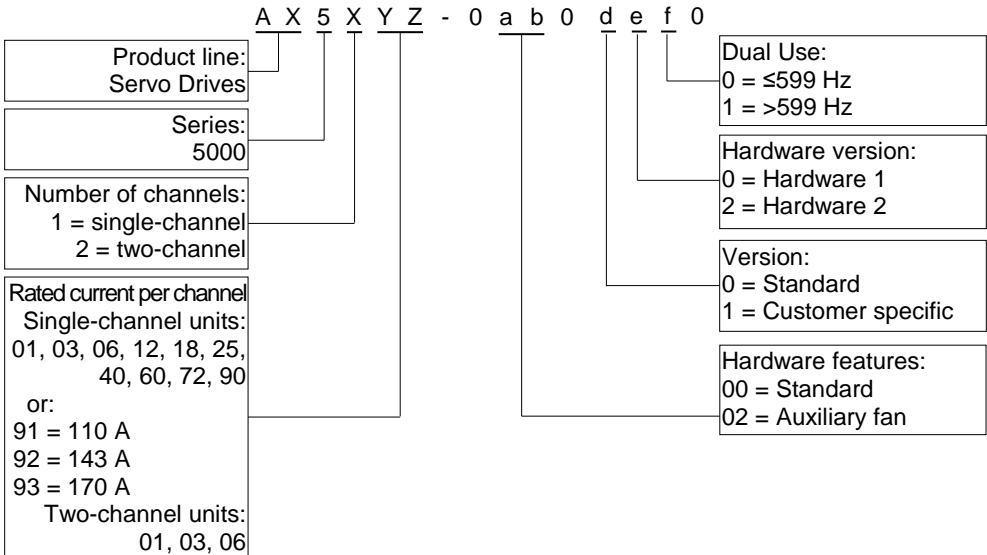

4.2 Scope of supply

The scope of delivery may vary depending on the ordered configuration. Before installing the device please ensure that all ordered components were delivered and that they are undamaged. In the event of any damage please contact the carrier immediately and document the damage.

4.2.1 Standard scope of supply

- AX5000 in the performance class according to the order
- Connectors for:
 - X01: Mains input
 - X02: DC link
 - X03: DC power supply 24 V
 - X06: Digital inputs and outputs
 - X07: External brake resistor (only AX5140)
- Startup (this manual)

4.2.2 Accessories

A comprehensive list of accessories can be found in the complete Beckhoff catalogue or on our website at www.beckhoff.com.

	<p>Accessories with UL-Listing!</p> <p>If you wish to operate an AX5000 in USA or Canada , please make sure that the accessories also have a UL-Listing.</p>
--	---

4.3 Name plate

The servo drive features two name plates. A comprehensive name plate can be found on the right-hand side. An extract showing the main data can be found at the top of the servo drive.

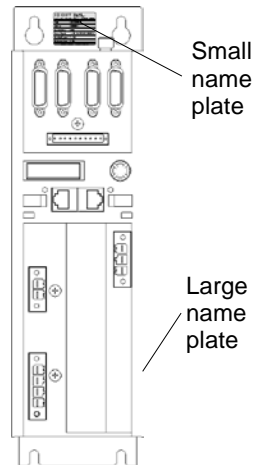
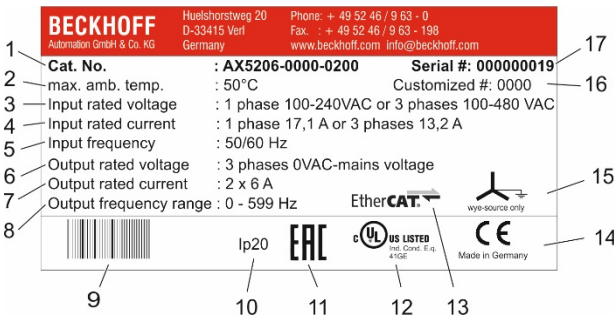

1	Catalog number	7	Output rated current	13	EtherCAT – Conform
2	Max. ambient temperature	8	Output frequency range	14	CE – Conform
3	Input rated voltage	9	Barcode	15	wye-source only
4	Input rated current	10	Protection class	16	Customer-specific
5	Input frequency	11	EAC - Conform	17	Serial number
6	Output rated voltage	12	cULus – Listed		

4.4 Technical data

	<p>UL-Listing!</p> <p>It is essential to observe chapter 3.3 if you wish to operate an AX5000 in USA or Canada.</p>
--	--

4.4.1 Permissible ambient and operating conditions

Ambient / operating conditions	Permissible values
Ambient temperature during operation	0 °C to +50 °C
Ambient temp. during transport/storage	-25 °C to +70 °C
Air humidity	5 % to 95 %, non-condensing
Pollution degree	2 according to EN 60204/EN 50178
Corrosion protection	Normally not required. Under extreme operating conditions separate measures must be agreed with the manufacturer.
Operating altitude	up to 1000 m above sea level without reduced power Between 1000 m and max. 3000 m with reduced power 1.5% per 100 m.
Installation position	vertical
Ventilation	Total device current ≤ 3 A: free convection Total device current > 3 A: built-in temperature-controlled fan
Protection class	IP 20
Vibration test (EN 60068-2-6)	Frequency range: 10-500 Hz Amplitude: 10-58 Hz = 0,075 mm pk-pk 59-500 Hz = 1 g
Shock test (EN 60068-2-27)	Half sine wave amplitude: 5 g Duration: 30 ms Number of shocks: 3 per axis and direction (total 18)
Repetitive shock test (EN 60068-2-27)	Half sine wave amplitude: 5 g Duration: 30 ms Number of shocks: 1000 per axis and direction (total 6000)

4.4.2 Electrical data - single-channel servo drive (AX51xx)

4.4.2.1 Single-phase connection

Electrical data	AX5101	AX5103	AX5106
Rated output current	1.5 A	3 A	4.5 A
Minimum channel current at full current resolution	0.35 A	1 A	1 A
Max. output current ⁽¹⁾	4.5 A	7.5 A	13 A
Rated supply voltage	1x 100 _{-10%} – 240 _{+10%} V _{AC}		
Max. DC link voltage	875 V _{DC}		
DC-link capacitance	235 μ F		
Rated apparent power S1 mode (selection)			
120 V	0.3 kVA	0.6 kVA	1.2 kVA
230 V	0.6 kVA	1.2 kVA	2.4 kVA
Power dissipation ⁽²⁾	35 W	50 W	85 W
Continuous braking power	50 W	50 W	150 W

Electrical data	AX5101	AX5103	AX5106
(with internal brake resistor)			
Max. braking power (with internal brake resistor)	14 kW		
Min. brake resistor (external brake resistor)	47 Ω		
Max. braking power (with external brake resistor)	15 kW		

(1) I_{eff} for max. 7 s

(2) S1 mode, including power supply unit, without brake chopper

4.4.2.2 Three-phase connection

Electrical data	AX							
	5101	5103	5106	5112	5118	5125	5140	
Rated output current [A]	1,5	3	6	12	18	25 ⁽¹⁾	40	
Minimum channel current at full current resolution [A]	0,35	1	1	6	12	12	18	
Max. output current ⁽³⁾ [A]	4,5	7,5	13	26	36	50	80 ⁽⁴⁾	
Rated supply voltage [V _{AC}]	3x 100 ^{-10%} – 480 ^{+10%} ⁽²⁾							
Max. DC link voltage [V _{DC}]	875							
DC-link capacitance [μF]	235			471		1175	1485	
Rated apparent power S1-mode (selection) [kVA]								
120 V	0,3	0,6	1,2	2,5	3,4	4,8	8,3	
230 V	0,6	1,2	2,4	4,8	7,2	10,0	16,0	
400 V	1,0	2,1	4,2	8,3	12,5	17,3	27,7	
480 V	1,2	2,5	5,0	10,0	15,0	20,8	33,3	
Power dissipation ⁽⁵⁾ [W]	35	50	85	160	255	340	510	
Max. continuous braking power [W] (with internal brake resistor)	50	50	150	90	200	200	150	
Max. braking power [kW] (with internal brake resistor)	14				26	26	26	
Min. brake resistor (external brake resistor) [Ω]	47	47	47	30	22	22	22 ⁽⁶⁾	
Max. braking power (external brake resistor) [kW]	15	15	15	23,5	32	32	32	

(1) $cU_{Lus} = 24$ A

(2) $cU_{Lus} = AX5118$ und $AX5125 = 3 \times 480 V_{AC} \pm 10\%$

(3) I_{eff} for max. 7 s

(4) I_{eff} for max. 7 s, if rotating field frequency >3 Hz at max. 40°C

(5) S1 mode, including power supply unit, without brake chopper

(6) Brake resistor < 22 Ω -> Please consult our Application Department

4.4.3 Electrical data - two-channel servo drive (AX52xx)

4.4.3.1 Single-phase connection

Electrical data	AX5201	AX5203	AX5206
Rated output current / channel	1.5 A	3 A	6 A
Minimum channel current at full current resolution	0.35 A	1 A	1 A
Maximum rated channel current	3 A	4.5 A	9 A
Total rated output current	3 A	4.5 A	9 A
Max. output current ⁽¹⁾ /channel	5 A	10 A	13 A
Max. output current ⁽¹⁾ total device current	10 A	20 A	26 A
Rated supply voltage	1x 100-10% – 240 ^{+10%} V _{AC}		
Max. DC link voltage	875 V _{DC}		
DC-link capacitance	235 µF	235 µF	470 µF
Rated apparent power S1 mode (selection)			
120 V	0.6 kVA	1.2 kVA	2.5 kVA
230 V	1.2 kVA	2.4 kVA	4.8 kVA
Power dissipation ⁽²⁾	55 W	85 W	160 W
Continuous braking power (with internal brake resistor)	50 W	150 W	90 W
Max. braking power (with internal brake resistor)	14 kW		
Min. brake resistor (external brake resistor)	47 Ω		
Max. braking power (with external brake resistor)	15 kW		

⁽¹⁾ I_{eff} for max. 7 s

⁽²⁾ S1 mode, including power supply unit, without brake chopper

4.4.3.2 Three-phase connection

Electrical data	AX5201	AX5203	AX5206
Rated output current per channel	1.5 A	3 A	6 A
Minimum channel current at full current resolution	0.35 A	1 A	1 A
Maximum rated channel current	3 A	6 A	9 A
Total rated output current	3 A	6 A	12 A
Max. output current ⁽¹⁾ /channel	5 A	10 A	13 A
Peak output current ⁽¹⁾ total device current	10 A	20 A	26 A
Rated supply voltage	3x 100-10% – 480 ^{+10%} V _{AC}		
Max. DC link voltage	875 V _{DC}		
DC-link capacitance	235 µF	235 µF	470 µF

Electrical data	AX5201	AX5203	AX5206
Rated apparent power S1 mode (selection)			
120 V	0.6 kVA	1.2 kVA	2.5 kVA
230 V	1.2 kVA	2.4 kVA	4.8 kVA
400 V	2.1 kVA	4.2 kVA	8.3 kVA
480 V	2.5 kVA	5.0 kVA	10.0 kVA
Power dissipation ⁽²⁾	55 W	85 W	160 W
Continuous braking power (with internal brake resistor)	50 W	150 W	90 W
Max. braking power (with internal brake resistor)	14 kW		
Min. brake resistor (external brake resistor)	47 Ω		
Max. braking power (with external brake resistor)	15 kW		

⁽¹⁾ I_{eff} for max. 7 s

⁽²⁾ S1 mode, including power supply unit, without brake chopper

SCCR-Values:

AX5x01 – AX5140 = 18 kA

4.4.4 Mechanical data (single-channel servo drive)

Mechanical data	AX						
	5101	5103	5106	5112	5118	5125	5140
Weight [kg]	ca. 4	ca. 4	ca. 5	ca. 5	ca. 11	ca. 11	ca. 13
Width [mm]	92				185		
Height without plugs [mm]	274						
Depth without connectors/ accessories [mm]	232						

4.4.5 Mechanical data (two-channel servo drive)

Mechanical data	AX5201	AX5203	AX5206
Weight	approx. 5 kg	approx. 6 kg	approx. 6 kg
Width	92 mm		
Height without plugs	274 mm		
Depth without connectors / accessories	232 mm		

4.5 General overview (AX5101 – AX5112 and AX520x)

The servo drive shown below is a two-channel device. Components that are only available for the second channel are identified in the item description.

Item description:

No	Designation
1	X11 – feedback connection, encoder
2	X12 – feedback connection, resolver
3	X21 – feedback connection, encoder channel B (only for two-channel unit)
4	X22 – feedback connection, resolver channel B (only for two-channel unit)
5	X3x – optional slot for safety card X4x – optional slot for expansion cards
6	Navigation rocker
7	Status LED for EtherCAT output
8	Labeling field
9	X05 – socket for EtherCAT output
10	X03 – power supply 24 V DC input
11	X14 – sensor for motor temperature and brake
12	X24 – sensor for motor temperature and brake channel B (only for two-channel unit)
13	X23 – motor connection (U, V, W, PE) channel B (only for two-channel unit)
14	X13 – motor connection (U, V, W, PE)
15	X01 – mains supply 100 – 480 V
16	X02 – DC link output (875 V DC voltage) Connection for the external brake resistor
17	 875 V DC voltage at the DC link terminals. Dangerous voltage may be present for 5 minutes after the device is switched off. The device is safe once the voltage has fallen below 50 V.
18	X04 – socket for EtherCAT input
19	Labeling field
20	Status LED for EtherCAT input
21	Display
22	X06 – connection for digital inputs and outputs

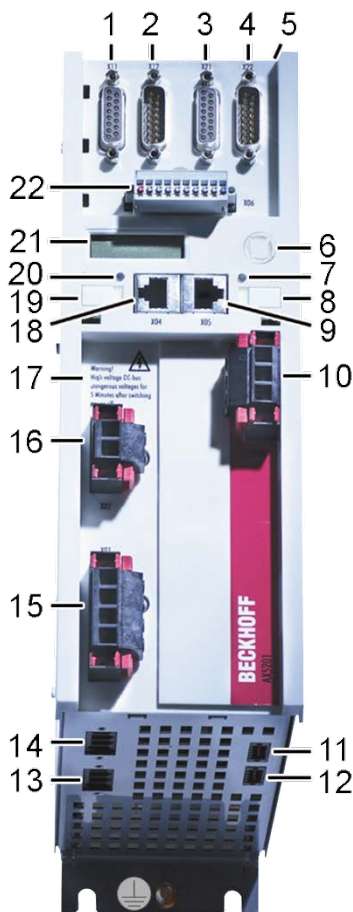

4.6 General overview (AX5118, AX5125 und AX5140)

The servo drive illustrated below is an AX5140; the devices with 18 A or 25 A are structurally similar apart from pos. 11 "X07" (external brake resistor).

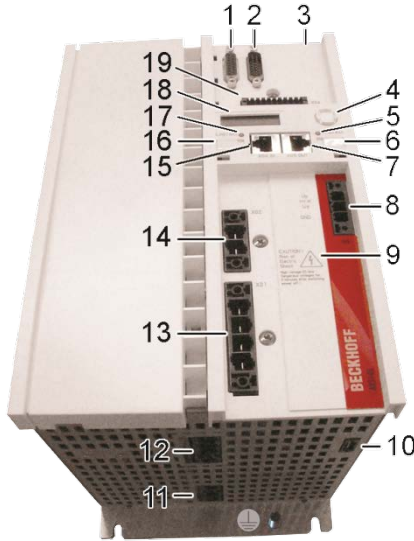

Item description:

No	Designation	No	Designation
1	X11 – feedback connection, encoder	11	X07 – external brake resistor (only AX5140)
2	X12 – feedback connection, resolver	12	X13 – motor connection (U, V, W, PE)
3	X3x – optional slot for safety card X4x – optional slot for expansion cards	13	X01 – mains supply 100 – 480 V
4	Navigation rocker	14	X02 – DC link output (875 V DC voltage) Connection for the external brake resistor (only AX5118 u. AX5125)
5	Status LED for EtherCAT output	15	X04 – socket for EtherCAT input
6	Labeling field	16	Labeling field
7	X05 – socket for EtherCAT output	17	Status LED for EtherCAT input
8	X03 – power supply 24 V DC input	18	Display
9	 WARNING Max. 875 V DC voltage at the DC link terminals. Dangerous voltage may be present for 15 minutes after the device is switched off. The device is safe once the voltage has fallen below 50 V.	19	X06 – connection for digital inputs and outputs
10	X14 – sensor for motor temperature and brake		

4.7 Overview of connectors/terminal points

4.7.1 X01 - wide voltage input



Terminal point	Connection		Tightening torque
	3-phase	1-phase	
L1	Phase L1	Phase L1	0,5 -0,6 Nm
L2	Phase L2	not used	
L3/ N	Phase L3	Neutral conductor	
PE	Protective conductor		

4.7.2 X02 - DC link (AX5101 - AX5125 und AX520x)



Terminal point	Connection		Tightening torque
DC+	DC link +	external brake resistor and drive system	0,5 -0,6 Nm
DC -	DC link -		

4.7.3 X02 - DC link (Only AX5140)



Terminal point	Connection		Tightening torque
DC+	DC link +	only for drive system	1,2 -1,5 Nm
DC -	DC link -		



WARNING

Serious risk of injury through high electrical voltage!

875 V DC voltage at the DC link terminals. Dangerous voltage may be present for 5 minutes after the device is switched off. Measure the voltage at the DC link contacts DC+ and DC-. The device is safe once the voltage has fallen below 50 V.

Remove the connector only if you want to build a drive system with a AX-Bridge. Remove the white hexagon plugs only if you wire the terminal points again.

4.7.4 X03 - 24 V_{DC} supply



Terminal point	Connection	Current consumption	Tightening torque
U _p +	Periphery supply 24 V _{DC} ±10 (depending on the motor holding brake)	Depending on the connected consumers (see X06 and X14,X24)	0,5 – 0,6 Nm
U _s +	System supply 24 V _{DC} ±25%	-12 A = 0,4 A – 0,8 A 18 A – 25 A = 1,1 A 40 A = 1,6 A	
GND	GND		

4.7.5 X04, X05 - EtherCAT connection

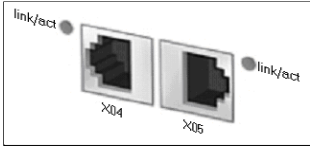

Terminal point	Connection
X04 (IN)	incoming EtherCAT line
X05 (OUT)	outgoing EtherCAT line

4.7.6 X06 – Digital I/Os

	<p>Destruction of the AX5000!</p> <p>This connector is not designed for external power supply. It is supplied via the 24 V supply (U_p) of connector X03.</p>
--	---

	<p>Output current</p> <p>The specified output currents are maximum values. The actual values depend on your current configuration.</p>
--	---

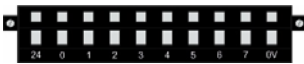

Terminal point	Connection	Output current
24	Output voltage (U_p 24 V _{DC} +)	1 A max.
0	Input 0	
1	Input 1	
2	Input 2	
3	Input 3	
4	Input 4	
5	Input 5	
6	Input 6	
7	Input 7 or output (configurable) (U_p 24 V _{DC} +)	0.5 A max.
0 V	Output voltage GND (-)	

4.7.7 X11 (channel A) , X21 (channel B) - feedback, high-resolution

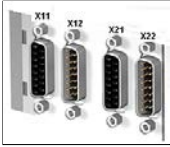

Pin	EnDAT / BiSS	Hiperface	Sin / Cos 1Vpp	TTL ¹⁾
1	SIN +	SIN +	SIN +	n.c.
2	GND_5 V	GND_9 V	GND_5 V	GND_5 V
3	COS +	COS +	COS +	n.c.
4	U _{s_5 V} ²⁾	n.c.	U _{s_5 V} ²⁾	U _{s_5 V} ²⁾
5	DX + (Data)	DX + (Data)	n.c.	B +
6	n.c.	U _{s_9 V} ²⁾	n.c.	n.c.
7	n.c.	n.c.	REF Z	REF Z
8	CLK + (Clock)	n.c.	n.c.	A +
9	REFSIN	REFSIN	REFSIN	n.c.
10	GND_Sense	n.c.	GND_Sense	GND_Sense
11	REF COS	REF COS	REF COS	n.c.
12	U _{s_5 V} Sense	n.c.	U _{s_5 V} Sense	U _{s_5 V} Sense
13	DX - (Data)	DX - (Data)	n.c.	B -
14	n.c.	n.c.	Z +	Z +
15	CLK - (Clock)	n.c.	n.c.	A -

¹⁾ **Attention: Wire break detection for TTL encoder is not supported**

²⁾ The max. output current per channel is 0,25 A

4.7.8 X12 (channel A) , X22 (channel B) - resolver/hall

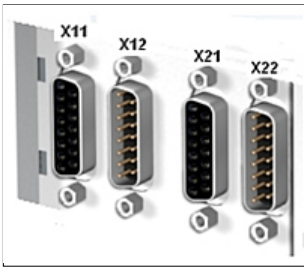

Pin	Feedback system	
	Resolver	Analog Hall sensor
1	Temperature (only PTC, Klixon or bimetal!) Switchpoint: 1300 Ω ± 3%	n.c.
2	AGND	n.c.
3	COS - (S3)	n.c.
4	SIN - (S4)	n.c.
5	REF - (R2)	n.c.
6	n.c.	SIN 1Vpp
7	n.c.	-120° oder -90° 1Vpp ^{*)}
8	n.c.	U _{s_9 V} (supply)
9	Temp_GND	n.c.
10	COS + (S1)	n.c.
11	SIN + (S2)	n.c.
12	REF + (R1)	n.c.
13	n.c.	REFSIN 1 Vpp
14	n.c.	REF -120° oder -90° 1Vpp ^{*)}
15	n.c.	GND (supply)

^{*)} The angle must be configured

4.7.9 X13 (channel A) , X23 (channel B) - motor connection (power)
(AX5101 - AX5125 und AX520x)



Terminal point	Connection	Tightening torque (Knurled screw)
U	Motor connection U	0,6 Nm
V	Motor connection V	
W	Motor connection W	
PE	Protective conductor	
Shroud	Screen	

4.7.10 X13 - motor connection (power - only AX5140)



Terminal point	Connection
U	Motor connection U
V	Motor connection V
W	Motor connection W
PE	Protective conductor
Shroud	Screen

 Attention	<p>Grounding shield!</p> <p>The grounding shield of the motor is connected via the shield plate in the motor connector. Please tighten the knurled screws of the motor connector with a screwdriver. It is possible that some feedback problems may be caused due to a poor shield connection of the motor.</p>
----------------------	--

4.7.11 X14 (channel A), X24 (channel B)-motor brake, thermal contact, OCT



AX5000-xxxx-0000 (Hardware 1)

Terminal point	Connection	Output current	Conductor cross-section	Tightening torque
T-	Temp. - *		0.2 – 1.5 mm ²	0.2 – 0.25 Nm
T+	Temp. + *			
PE	Signal pair screen			
B-	Brake GND			
B+	Brake (U _p) +	1.5 A max.		

*) Switch, KTY 83-1xx or KTY 84-1xx

AX5000-xxxx-0200 (Hardware 2)

Terminal point	Connection	Output current	Conductor cross-section	Tightening torque
T-	OCT – and temp.		0.2 – 1.5 mm ²	0.2 – 0.25 Nm
T+	OCT + and temp.			
PE	Signal pair screen			
B-	Brake GND			
B+	Brake (U _p) +	2.2 A max.		



Note

Output current

The specified output current is the maximum value. The actual value depends on your current configuration.

4.7.12 X07 – internal and external brake resistor (Only AX5140)



Terminal point	Connection
PE	Protective conductor
+ R _B	External brake resistor +
+ R _{Bint}	Internal brake resistor +
- R _B	Brake resistor GND



Note

Operation of AX5140

Commissioning the AX5140 can only be carried out when the terminal points "+R_{Bint}" and "+R_B" are bypassed (delivery state) or an external brake resistor is connected (terminal points "+R_B" and "-R_B"). If these measures are not taken then the AX5140 will be stopped with the error message "FD4B – undervoltage"

**Serious risk of injury through high electrical voltage!**

875 V DC voltage at the brake terminals X07. Dangerous voltage may be present for 15 minutes after the device is switched off. Measure the voltage at the brake contacts +R_B und -R_B. The device is safe once the voltage has fallen below 50 V.

4.8 Dimensions

The specified measurements relate to the actual device, without connectors and cables. The fitting dimensions for control cabinet installation can be found in section "Mechanical installation → Installation examples".

AX5118, AX5125 and AX5140

AX5101-AX5112 / AX5201-AX5206

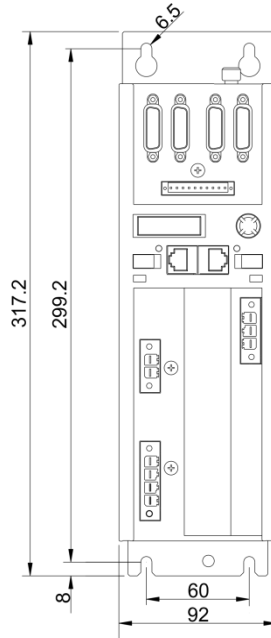
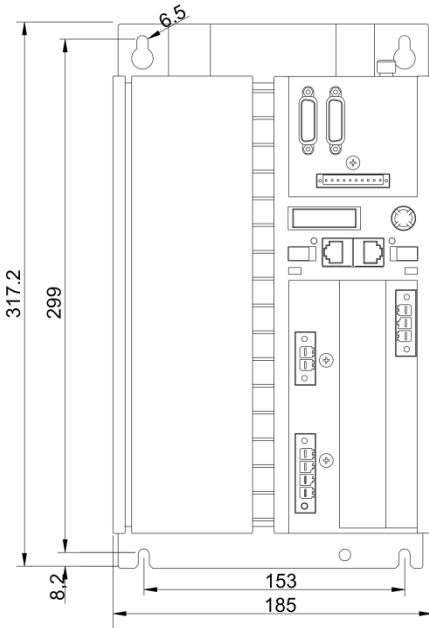

All dimensions are in mm

AX5000 without AX-Bridge

AX5000 with AX-Bridge

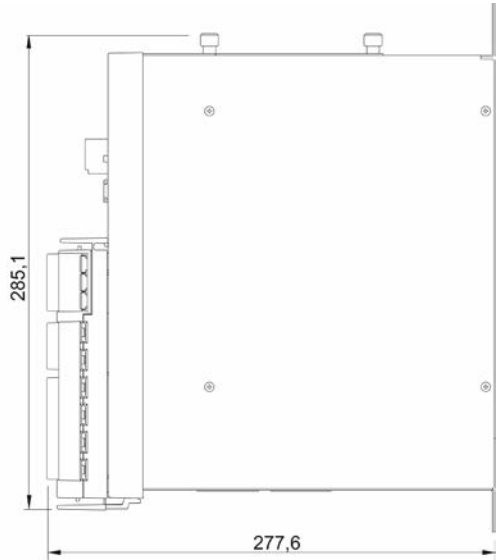
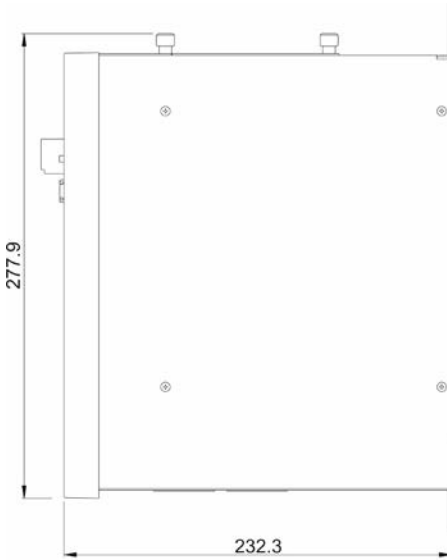

All dimensions are in mm

5 Installation

 <p>WARNING</p>	<p>Caution - Risk of injury through electric shock!</p> <p>De-energise all electrical components (servo drive, control cabinet, etc.) before commencing the installation or deinstallation.</p>
--	--

5.1 Mechanical installation

 <p>Attention</p>	<p>Destruction of the servo drive!</p> <ul style="list-style-type: none"> • Always install the servo drive vertically. • Provide adequate ventilation for the servo drive. The permissible ambient conditions are specified in the "Technical data" section. • It is essential to adhere to the required distances (see diagrams below).
---	--

5.1.1 Installation in the control cabinet

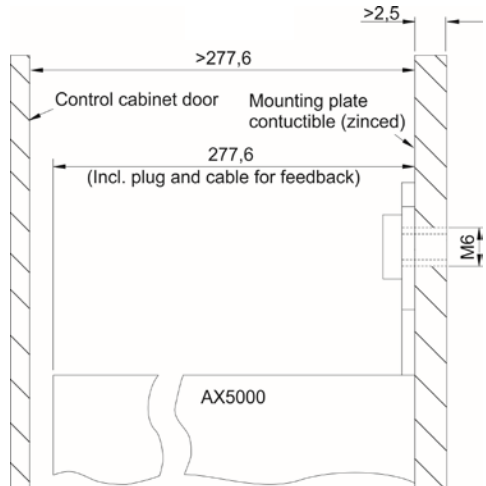

 <p>WARNING</p>	<p>Caution - Risk of injury through electric shock!</p> <p>The mounting plate must be earthed according to the statutory regulations.</p>
--	--

 <p>Attention</p>	<p>Connection of the protective earth conductor on the AX5000:</p> <p>The servo drives AX5000 have earthing bolts on the device housing. To attach the protective earth conductor via the earthing bolts, use at least the cross section that is applied to the wide voltage input "X01" (PE).</p>
---	---



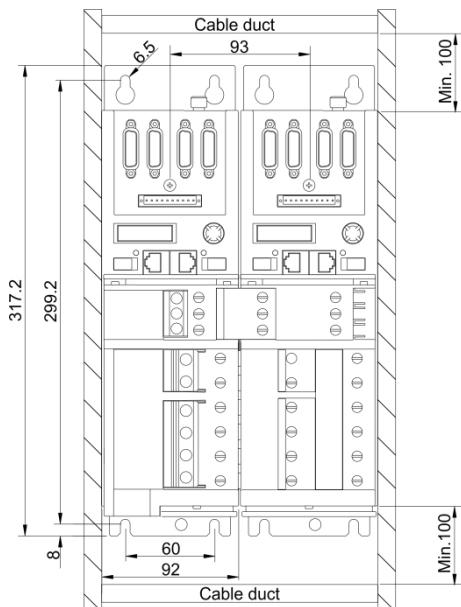

5.1.1.1 Installation example - AX5101-AX5112 and AX5201-AX5206

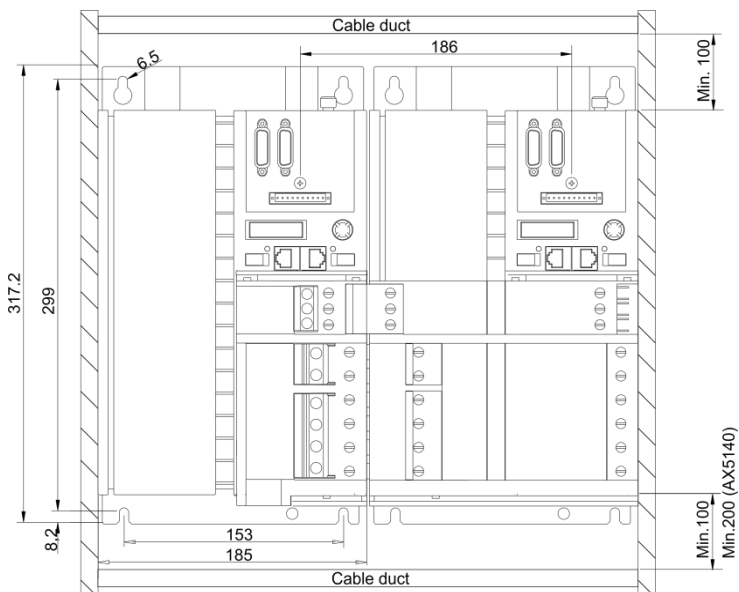

5.1.1.2 Installation example - AX5118, AX5125 and AX5140



5.2 Electrical installation

	<p>UL-Listing!</p> <p>It is essential to observe chapter 3.3 if you wish to operate an AX5000 in USA or Canada.</p>
 DANGER	<p>Serious risk of injury through electric shock!</p> <p>Due to the DC link capacitors dangerous voltage may persist at the DC link contacts "X02" after the servo drive has been disconnected from the mains supply. After disconnecting the servo drive wait 5 minutes and measure the voltage at the DC link contacts DC+ and DC-. The device is safe once the voltage has fallen below 50 V.</p>
 WARNING	<p>Caution – Risk of injury through electric shock!</p> <ul style="list-style-type: none">• Before installation, wiring and commissioning it is essential to read the section on "Safety".• Before installing, uninstalling or connecting the servo drive and the motors please note the following:<ul style="list-style-type: none">- Remove all relevant mains fuses.- Switch off the main system switch and secure it with a lock.- Put up a warning sign.• The control and power connections for the motors may be live, even if the motor is prevented from rotating by the internal brake.
 Attention	<p>Destruction of the equipment!</p> <ul style="list-style-type: none">• Check the rated voltage and current of the servo drive and the connected motors.• When the AX5000 is disconnected from the mains supply (emergency stop, mains contactor etc.), wait at least 3 minutes before starting again or query the status of the IDN "P-0-0205" (see documentation of the "IDN-Description").

5.2.1 Mains supply connection (X01)

The servo drives of the AX5000 series are equipped with a wide voltage input "X01" and can be connected to voltage systems between single-phase 100 V_{AC} -10% - 240 V_{AC} +10% and three-phase 100 V_{AC} -10% - 480 V_{AC} +10%.



Note

Connection to the standard mains supply (TT/TN) with earthed centre is described below. Details for connections to other supply systems (e.g. IT-mains supply, isolating transformer etc.) can be found in the "AX5000 User manual" on the enclosed CD or can be downloaded from our website at www.beckhoff.com.

single-phase 100_{-10%} - 240_{+10%} V_{AC}

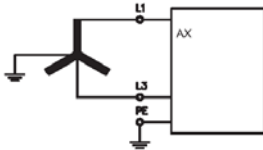

three-phase 100_{-10%} - 480_{+10%} V_{AC}

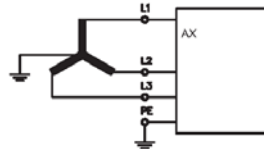

5.2.1.1 External protection for individual devices, CE-compliant



Fire hazard through short circuit!

- The following data refer to individual devices. Please note the total current of all connected devices in a multi-axis system.
- The recommended fuses are designed for line protection. The servo drives feature integrated self-protection.

Single-phase

Fusing	AX5101	AX5103	AX5106	AX5201	AX5203	AX5206
AC supply *)	10 A	10 A	16 A	10 A	16 A	20 A
24 V supply *)	5 A					
Brake resistor	electronic					

*) Application class "gG" mains fuses according to IEC 60269 with characteristic "T" or "C" type automatic circuit breakers must be used.

Three-phase

Fusing	AX									
	5101	5103	5106	5112	5118	5125	5140	5201	5203	5206
AC supply *)	6 AT	6 A	10 A	20 A	35 A	35 A	50 A	10 A	10 A	20 A
24 V supply *)	5 A									
Brake resistor	elektronisch									

*) Application class "gG" mains fuses according to IEC 60269 with characteristic "T" or "C" type automatic circuit breakers must be used.

5.2.1.2 Internal protection, CE-compliant

Circuit	Fuse
24 V - system voltage	3.4 AF
24 V - peripheral voltage	electronic
Brake resistor	electronic

5.2.1.3 External protection, UL-compliant

Integral solid state short circuit protection does not provide branch circuit protection. Branch circuit protection must be provided in accordance with the Manufacture Instructions, National Electrical Code and any additional local codes.

Suitable for use on a circuit capable of delivering not more than 18000 rms symmetrical amperes, 480 V maximum, when protected by RK5 class fuses.

For alternatives regarding class RK5 UL-fuses, you must observe “UL508 A, chapter SB4.2.3, exception no. 1”. For further questions regarding UL-fuses, please contact your responsible certification authority.

Single-phase

Fusing	AX5101	AX5103	AX5106	AX5201	AX5203	AX5206
AC supply (max.) *)	6 A	12 A	20 A	12 A	20 A	20 A
24 V supply (max.)	3 A					
Brake resistor	electronic					

*) UL-Mains fuses must be used.

Three-phase

Fusing	AX									
	5101	5103	5106	5112	5118	5125	5140	5201	5203	5206
AC suppl (max.) *)	6 A	12 A	20 A	20 A	35 A	45 A	80 A	12 A	20 A	20 A
24 V supply (max.)	3 A									
Brake resistor	elektronisch									

*) UL-Mains fuses must be used.

	When protected by RK5 class fuses:
	AX5112 Rated 20 A, min. 480 V
	AX5118 Rated 35 A, min. 480 V
	AX5125 Rated 45 A, min. 480 V
	AX5140 Rated 80 A, min. 480 V

5.2.1.4 Internal protection, UL-compliant

Circuit	Fuse
24 V - system voltage	3.4 AF
24 V - peripheral voltage	electronic
Brake resistor	electronic

5.2.1.5 External drive system protection

Rule of thumb: Determine the total device rated current, multiply by correction factor and round it up to the next higher standard level.

Example: $1 \times \text{AX5103} + 2 \times \text{AX5201} + 2 \times \text{AX5203}$
 $3 \text{ A} + 6 \text{ A} + 12 \text{ A} = 21 \times 1,1 = 23,1 \text{ A} \rightarrow \text{selected } 25 \text{ A}$



Special requirements for a drive system

Please note the configuration example in chapter 5.2.4

5.2.2 24 V_{DC} - supply network connection (X03)

The 24 V_{DC} connection "X03" is used for supplying control electronics and periphery with DC voltage. The control electronics and the periphery can be supplied separately with two different voltage sources.

 Note	<p>If one transformer is used for the 24 V_{DC} power supply, the connections U_s and U_p must be bridged, in order to ensure that both the control electronics and the periphery are supplied.</p>
--	---

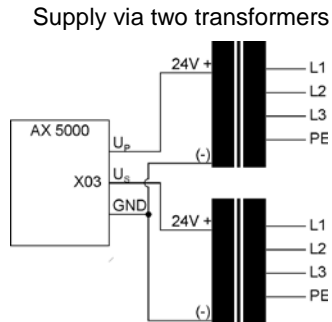
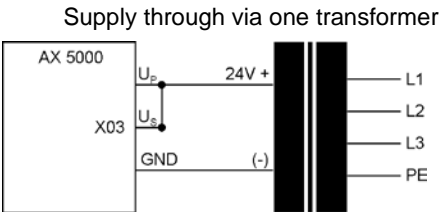

5.2.3 Connection of several servo drives to form a drive system

	<p>Drive system with UL-Listing! Please note the configuration example in chapter 5.2.4</p>
--	--

 Attention	<p>Hazard to the equipment</p> <ul style="list-style-type: none"> The connection sequence of the devices is <u>not</u> arbitrary. The total rated current of the device must decrease from the power supply. AX5112-AX5203-AX5106-AX5201 = OK; AX5201-AX5112-AX5203 ≠ OK All devices in a drive system are <u>always</u> to be disconnected from and reconnected to the mains supply together (emergency stop, mains contactor etc.).
---	--

 CAUTION	<p>Danger for persons and equipment</p> <p>Note the total rated current of the connected devices. According to CE the current carrying capacity of power busbars of the AX Bridge is limited to 85 A.</p>
--	--

 Attention	<p>Destruction of the external brake resistor</p> <p>An external brake resistor may not be connected to the X02 terminal point (DC link) in a drive system. Use an external brake module AX5021 for this.</p>
---	--

5.2.3.1 Connection example - module AX5901 and AX5911 (AX Bridge)

This connection option enables a safe system to be set up very quickly. The modules are attached to plug contacts X01, X02 and X03, the relevant slides are pushed to the left and screwed tight. According to CE the current carrying capacity of power busbars of the AX Bridge is limited to 85 A.



Hazard to individuals through electric shock

Move all busbar sliders to the left limit stop in order to ensure full current carrying capacity. Then tighten all screws with a torque of 2.2 Nm.



Hazard to individuals and equipment

Please ensure that the connection line for the AX5901 supply module is adequately dimensioned. The dimensioning depends on the total rated current and must comply with EN60204-1.

The supply connection is established as described in sections 5.2.1 and 5.2.2.

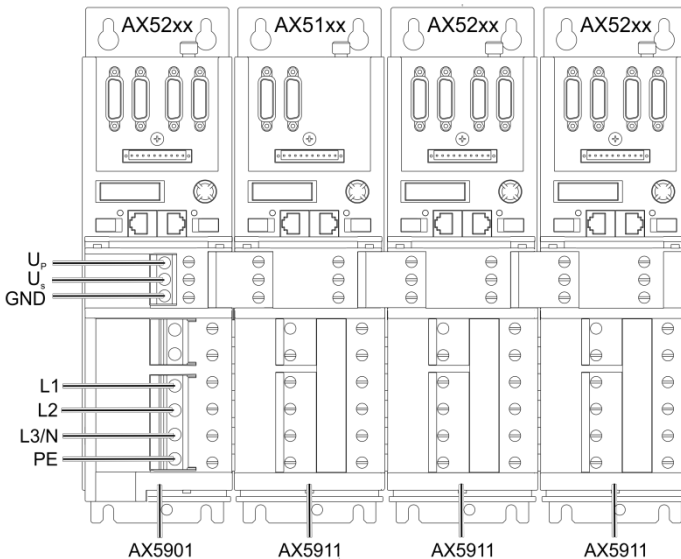

Information of the terminal points

Terminal points	Conductor design	max. Conductor cross-section	Tightening torque
L1-L3, PE	single wire	10 mm ²	2,2 Nm
L1-L3, PE	finely stranded with wire end sleeves	16 mm ²	2,2 Nm
L1-L3, PE	finely stranded / stranded	25 mm ²	2,2 Nm

5.2.3.2 Connection example - wiring in series without AX Bridge

Wire the relevant connections using individual cables.

 CAUTION	<p>Hazard to individuals and equipment</p> <ul style="list-style-type: none"> • Please ensure that the final supply network connection cable is adequately dimensioned. The dimensioning depends on the total rated current and must comply with EN60204-1. • To establish a DC link system wire the X02 connections with a suitable cable. Voltages up to 875 V may be present. • The connectors are designed for a maximum current of 41 A and a maximum conductor cross-section of 6 mm². • Avoid phase reversal between the devices!
--	--

The supply connection is established as described in sections 5.2.1 and 5.2.2.

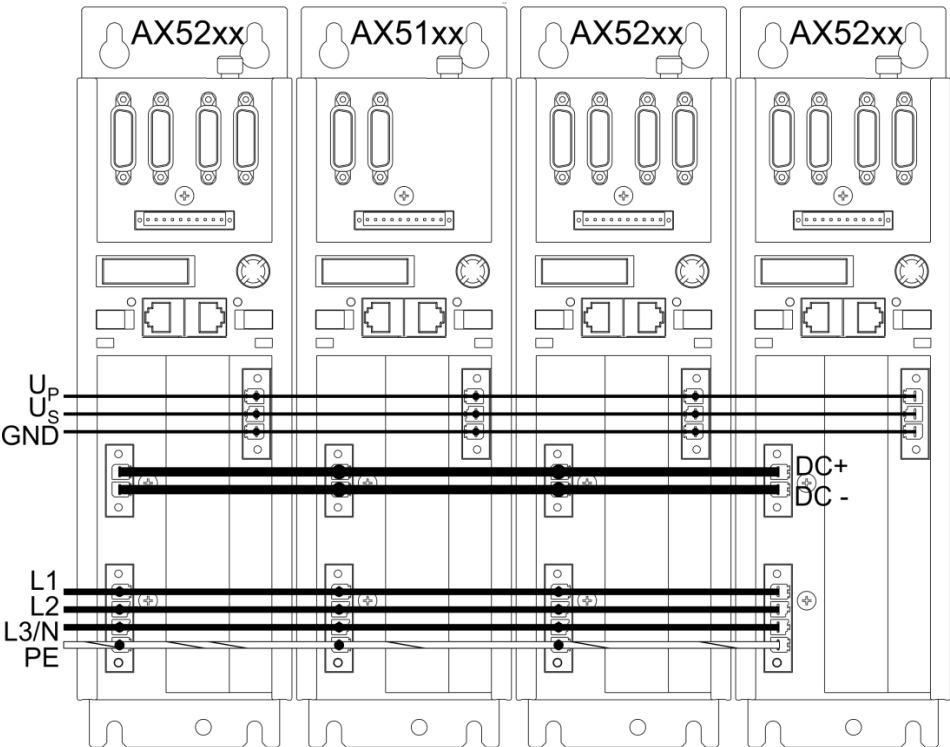

5.2.4 UL-Bridge, configuration example

	<p>Drive system with UL-Listing!</p> <p>The figure below shows a configuration example. Before realization, please contact your UL-certification authority and discuss the boundary conditions necessary. Please note that the AX Bridge has no UL-Listing!</p>
--	---

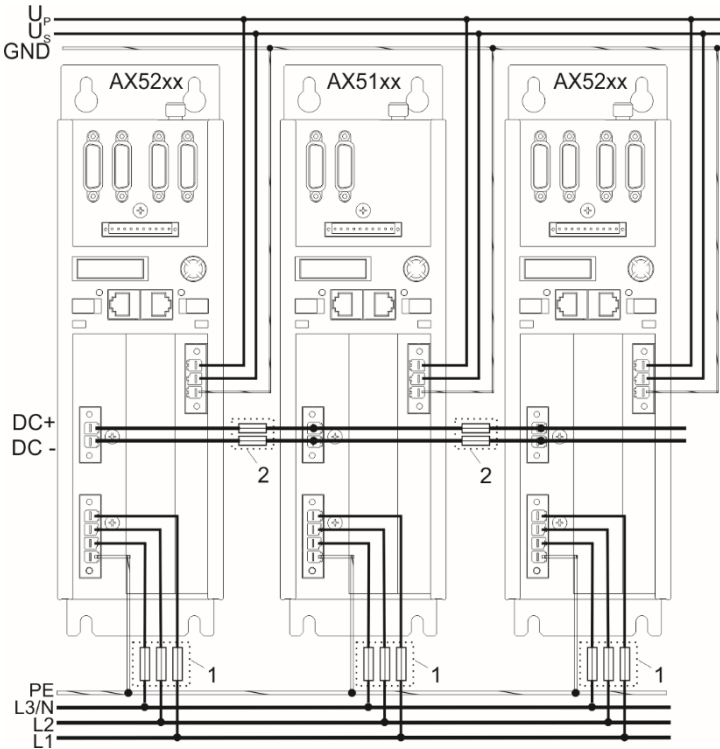

Legend:

1 = UL-Fuse (480 VAC)

2 = UL-Fuse (700 VAC / 800 VDC) e.g. Ferrule FWP from Cooper-Bussmann

	<p>UL-certified fuse holders</p> <p>When using UL-fuses, please make sure that the necessary fuse holders are UL-certified, as well.</p>
--	---

5.2.5 Connection diagram AX5101 – AX5112 and AX520x

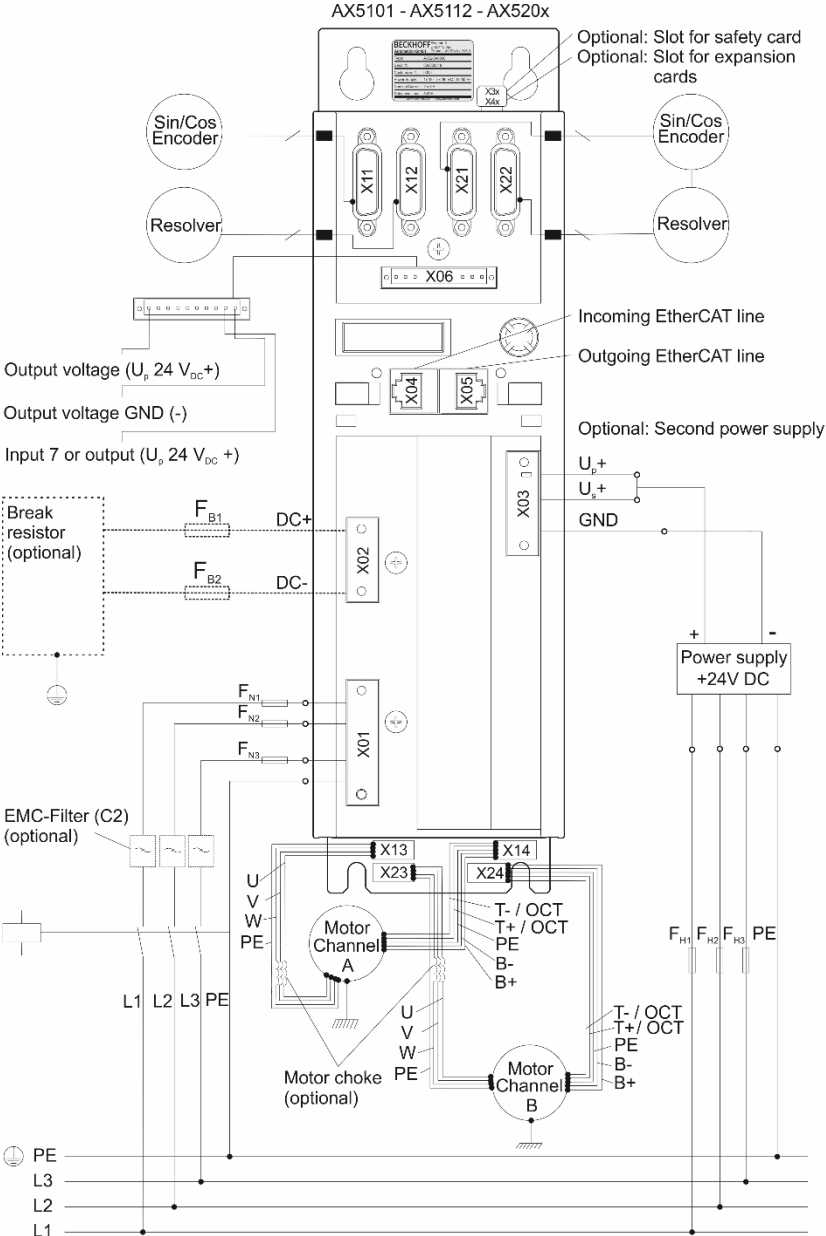

5.2.6 Connection diagram AX5118, AX5125 and AX5140

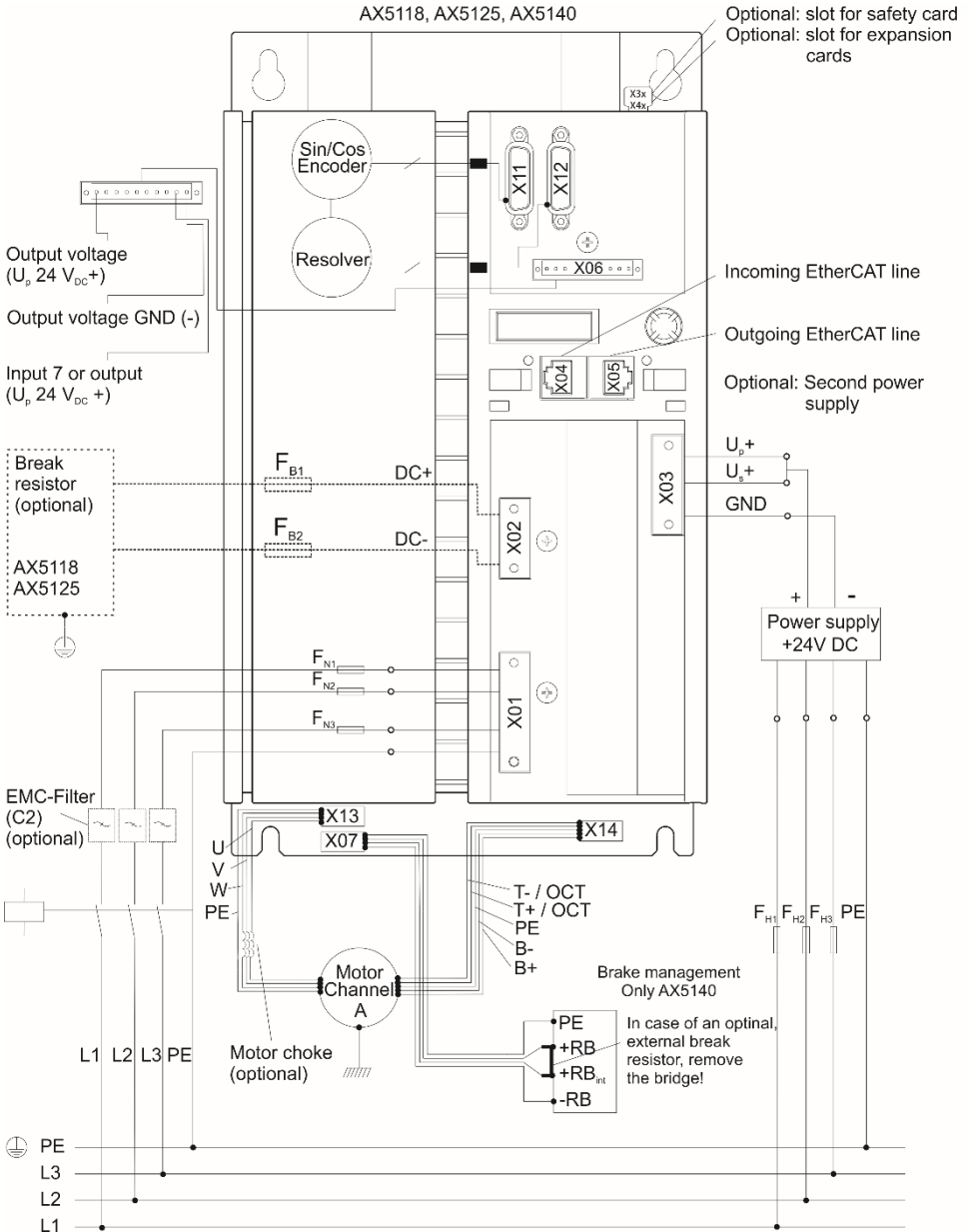

5.3 Motors and cables

With longer motor cables the resulting commutation currents can affect the control quality and lead to EMC faults. Use the tables below to check whether motor chokes or mains filters have to be used in your application. When selecting the control cabinet ensure that there is adequate space for motor chokes, mains filters, etc.

Lay the power and signal cables in separate metal cable ducts or, if both types of cable use the same metal cable duct, make sure there is an earthed metal dividing wall between the cables.

Maximum cable length (including extensions) for a rated motor voltage up to 400 V

Motor choke	AX5101 - AX5112 a. AX52xx		AX5118 a. AX5125		AX5140	
	C2 ¹⁾	C3	C2 ²⁾	C3	C2	C3
Without	< 25 m	< 25 m	< 25 m	< 25 m	-	< 35 m
AX2090-MD50-0012	< 100 m	< 100 m	-	-	-	-
AX2090-MD50-0025	-	-	< 50 m	< 50 m	-	-

1) For compliance with EN 61800-3 only with mains filter AX2090-NF50-0014.

2) For compliance with EN 61800-3 only with mains filter AX2090-NF50-0032.

In exceptional cases (sensitive sensors, etc.) it can be necessary to use a motor choke even for motor cable lengths < 25 m.

Maximum cable length (including extensions) for a rated motor voltage up to 480 V

Motor choke	AX5101 - AX5112 a. AX52xx		AX5118 a. AX5125		AX5140	
	C2 ¹⁾	C3	C2 ²⁾	C3	C2	C3 ³⁾
Without	< 20 m	< 20 m	< 20 m	< 20 m	-	< 35 m
AX2090-MD50-0012	< 100 m	< 100 m	-	-	-	-
AX2090-MD50-0025	-	-	< 50 m	< 50 m	-	-

1) For compliance with EN 61800-3 only with mains filter AX2090-NF50-0014.

2) For compliance with EN 61800-3 only with mains filter AX2090-NF50-0032.

3) C3 up to 100 m without mains choke for devices with order number AX5140-0000-1202.

In exceptional cases (sensitive sensors, etc.) it can be necessary to use a motor choke even for motor cable lengths < 20 m.

 Note	We recommend that feedback wires and motor wires used have the same length.
--	---

6 Important information for commissioning

 <p>WARNING</p>	<p>Caution – Risk of injury!</p> <p>Electronic equipment is not fail-safe. The machine manufacturer is responsible for ensuring that the connected motors and the machine are brought into a safe state in the event of a fault in the drive system.</p>
---	---

Please be aware each time before commissioning the AX5000 that connected motors can make uncontrolled movements, which cannot always be prevented even by the AX5000's integrated diagnostic system, or may permit uncontrolled movements until the diagnostic system responds. Analyse your system and take suitable precautions to prevent damage being caused by these uncontrolled movements.

Potential causes of uncontrolled movements:

The diagnostic system of the AX5000 is equipped with complex plausibility checks, which constantly monitor installation, operation, parameterisation and operation and, if necessary, interrupt them with a diagnostic message. The points listed below are naturally also monitored as standard, but it is not possible to include all eventualities; therefore, with respect to the following points, you must always consider whether the driven axes can only perform permissible movements.

- Incorrect commutation results (e.g. during wake & shake), It is essential to observe chapter "AX5000 System manual→Advanced system characteristics→commutation methods→commutation error "F2A0"" on our Homepage.
- **Specific caution with motors of third parties:** always execute the command „P-0-0166“ without load when changing the motor or feedback or when changing the SysMan-file (.TSM) and evaluate the result. Correct the commutation offset if applicable, as described in chapter "AX5000 System manual→Advanced system characteristics→commutation methods".
- Input of invalid parameters
- Measuring transducer and/or signal transducer defective or incorrectly adjusted
- Cables defective or not adequately screened
- Incorrectly attached sensors

 <p>CAUTION</p>	<p>Increased attention in the case of vertical axes!</p> <p>When commissioning vertical axes, the risk consideration described above is to be carried out with particular care. An uncontrolled movement can mean the sudden falling down of a load in this case.</p>
---	--

7 Project planning – important information

The more thoroughly a machine or plant project is thought through in advance, the less risk there is of having to carry out expensive modifications during or after commissioning. This applies to both the mechanical and electrical design. This section can only give a rough overview of electrical design.

7.1 Drive train design

Application, servo drive, motors and gear mechanism must be adapted to each other so that there is an adequate safety margin for all components as a degree of sluggishness appears over time due to high temperatures or wear. Make sure that the components in the working area of the system have adequate reserves so that the working life is not impaired and the necessary control quality can be maintained.

7.1.1 Control quality, mass inertia ratio and load connection

Control quality is dependent on the parameters "mass inertia ratio" and "load connection":

Control quality / Dynamics	Mass inertia ratio
Good	up to 3:1
Average	up to 5:1
Bad	from 5:1

The "Control quality / dynamics" is primarily affected by the mass moment of inertia: a poor "Control quality / dynamic" due to an unfavourable mass moment of inertia cannot be improved even with a very good load connection. Likewise, however, a good "Control quality / dynamic" due to a favourable mass moment of inertia can be reduced through a poor load connection.

7.2 Energy management

If the quality of the mains supply is impaired due to wide fluctuations in voltage, then both the servo drive specification and the speed range of the motor will need to be considered. With a positive tolerance for voltage fluctuation the upper limit value of the wide voltage input of the AX5000 needs to be taken into account. With a negative tolerance of the voltage fluctuation it must be checked whether the decrease in speed caused by the low voltage is permissible. With these motors what is known as field weakening operation (check availability) of the servo drive may provide a solution. If the mains supply does not meet the specifications for operation of the AX5000, then isolating transformers, mains chokes, mains filters or other measures may be required. An energy efficient drive system operates in a drive system with a shared DC link and shared internal and possibly also external brake resistors or brake modules. If you are already using similar drive systems, the AX5000 offers a convenient diagnostic system for determining the load on the brake resistors and for transferring the values. Previous experience with drive systems shows that in such a system much smaller or even no external brake resistors / brake modules need to be used.

7.3 EMC, earthing, screen connection and potential

The AX5000 corresponds to EMC category "C3" (industrial sector) in terms of conducted interference emissions. If you wish to use components which comply with a higher category you can limit the AX5000 conducted interference emissions with the aid of additional filters to such a degree that this complies with the EMC category "C2" (residential and industrial environment) or "C1" (residential environments).

Ensure that there is adequate earthing (large-area low-impedance connection) of all relevant components (incl. control cabinet). The AX5000 incl. periphery, control cabinet, machine bed and motors must be at the same potential, as the AX5000 control quality will suffer under differing potentials and operational malfunction may result. Using the screen connection for potential equalisation is not permitted. If you are unable to provide a uniform reference potential you need to lay potential equalisation cables of adequate dimensions. Smooth operation is only guaranteed by faultless screen connections of the cables. The screens must be applied generously at both ends and must on no account be disconnected. Use pre-assembled Beckhoff motor and feedback cables as these are optimally adapted to the drive system and reduce interference to a minimum. Ensure that the connectors are properly connected: this applies to the motor connector in particular.

7.4 Control cabinet

The dimensions of the control cabinet must be sufficient to accommodate all components with the specified distances. Remember that high temperatures may necessitate forced cooling. Position the control cabinet as close as possible to the machine so that the motor cables can be as short as possible.

In addition, the control cabinet should have an earthed metal rear panel to which the AX5000 incl. periphery are attached so that safe earthing can be guaranteed. If you are unable to guarantee these conditions you need to earth the AX5000 and the relevant components using an approved cable of adequate size.

8 Appendix

8.1 Support and Service

Beckhoff and their partners around the world offer comprehensive support and service, making available fast and competent assistance with all questions related to Beckhoff products and system solutions.

8.1.1 Beckhoff's branch offices and representatives

Please contact your Beckhoff branch office or representative for [local support and service](#) on Beckhoff products!

The addresses of Beckhoff's branch offices and representatives round the world can be found on her internet pages: <http://www.beckhoff.com>

You will also find further [documentation](#) for Beckhoff components there.

8.1.2 Beckhoff Headquarters

Beckhoff Automation GmbH & Co. KG
Hülshorstweg 20
33415 Verl
Germany

Phone: +49(0)5246/963-0

Fax: +49(0)5246/963-198

E-Mail: info@beckhoff.com

8.1.3 Beckhoff Support

Support offers you comprehensive technical assistance, helping you not only with the application of individual Beckhoff products, but also with other, wide-ranging services:

- Support
- Design, programming and commissioning of complex automation systems
- Extensive training program for Beckhoff system components

Hotline : +49(0)5246/963-157

Fax : +49(0)5246/963-9157

E-Mail : support@beckhoff.com

8.1.4 Beckhoff Service

The Beckhoff Service Center supports you in all matters of after-sales service:

- On-site service
- Repair service
- Spare parts service

Hotline : +49(0)5246/963-460

Fax : +49(0)5246/963-479

E-Mail : service@beckhoff.com