

E21235

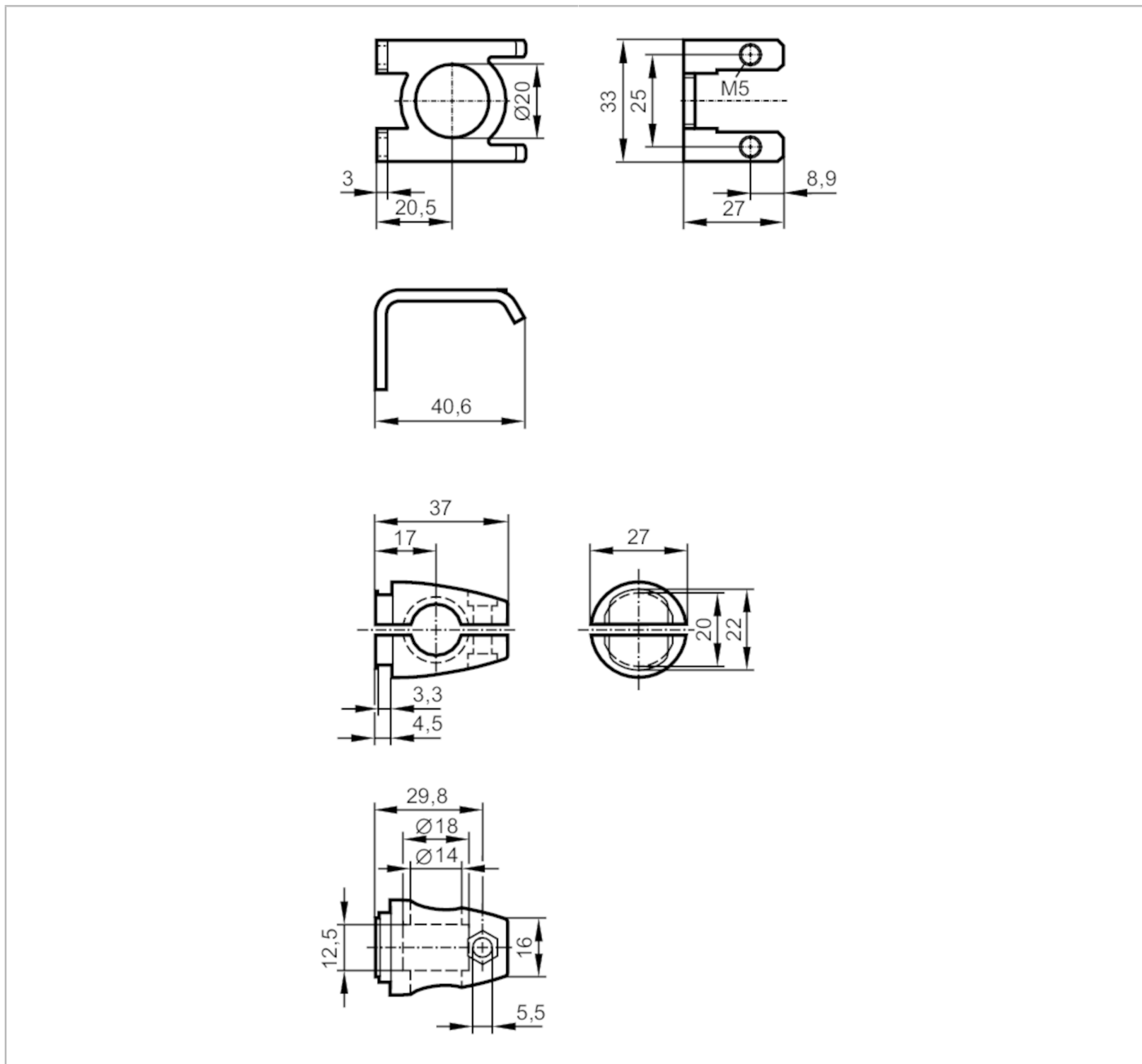

Mounting set for photoelectric sensors

O5 MOUNTING BRACKET 200



Application	
Design	clamp mounting
Mechanical data	
Weight [g]	98.8
Type of mounting	Mounting rod; (Ø 14 mm)
Materials	stainless steel (1.4571/316Ti); Clamp: diecast zinc
Accessories	
Accessories (supplied)	cylinder screws: 2 x M5 x 8
Remarks	
Pack quantity	1 pcs.