

E60065

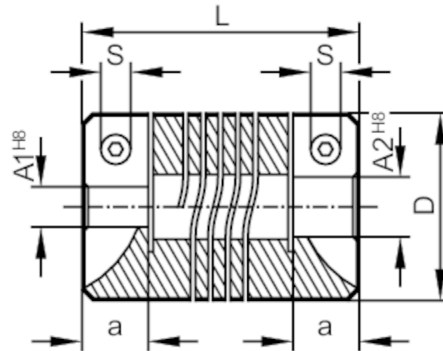

Flexible coupling for encoders

COUPLING 25-6-6-32-KV



Mechanical data	
Weight [g]	36.6
Materials	aluminium
External diameter D [mm]	25
inside diameter A1 [mm]	6
inside diameter A2 [mm]	6
Length L [mm]	32
depth of the clamping hub [mm]	8
Clamp screw [mm]	M3
Max. revolution, mechanical [U/min]	6000
Max. axial shaft misalignment [mm]	± 0,5
Max. radial shaft misalignment [mm]	± 0,35
Max. angular displacement [°]	± 4,0
Remarks	
Remarks	The data indicated apply to couplings with the above hub borings at an ambient temperature of 23 °C. The values of radial, angular and axial displacement are maximum values which must not reach their maximum simultaneously while in operation.
Pack quantity	1 pcs.