

E11807

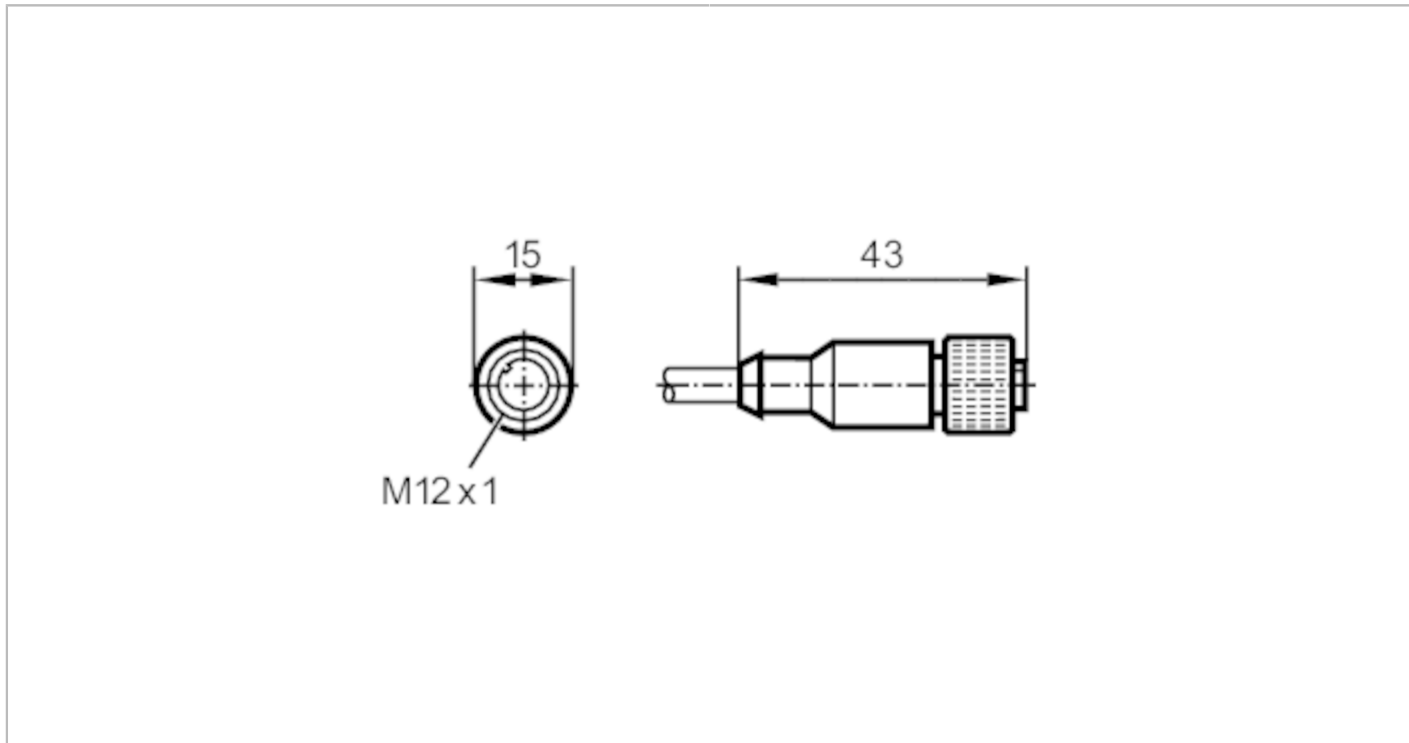

Connecting cable with socket

ADOGH080MSS0005H08



Electrical data

Operating voltage	[M]	< 30 AC / < 36 DC
-------------------	-----	-------------------

Operating conditions

Ambient temperature	[°C]	-25...80
Protection		IP 68

Mechanical data

Weight	[g]	317.6
Dimensions	[mm]	15 x 15 x 43
Materials		PUR
Material nut		brass

Remarks

Notes	For 8-pole sockets the core colours are not standardised.; Please note the wiring of the sensor and the sockets (see data sheet).
Pack quantity	1 pcs.

Electrical connection

Cable: 5 m, PUR, Halogen-free, black, Ø 6.2 mm; 8 x 0.25 mm²

Electrical connection - socket

Connector: 1 x M12, straight; Moulded body: PUR; Locking: brass, nickel-plated; Tightening torque: 0.7...0.9 Nm

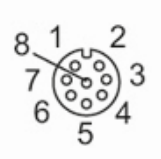

E11807



Connecting cable with socket

ADOGH080MSS0005H08

Connection

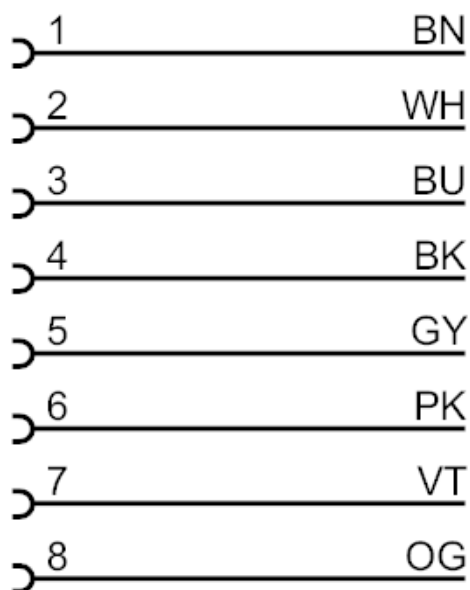

colours to DIN EN
60947-5-2

Core colours :

BK =	black
BN =	brown
BU =	blue
GY =	grey
PK =	pink
OG =	orange
VT =	lilac
WH =	white