

EVC16A

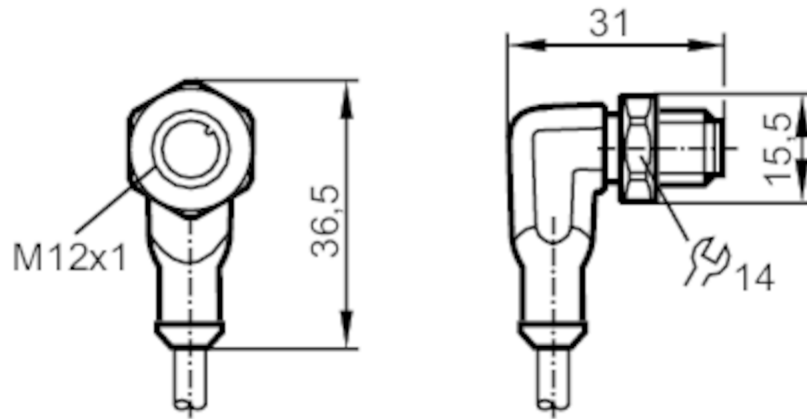

Connecting cable with plug

ASTAH040VAT0005H04/3G/2D



Application	
Free from silicone	yes
Electrical data	
Operating voltage [V]	< 60 AC/DC
Protection class	II
Max. current load total [A]	2
Operating conditions	
Ambient temperature [°C]	-20...60
Protection	IP 67; (outside hazardous areas: IP 68 / IP 69K)
Tests / approvals	
Approval	BVS 08 ATEX E 109 U; IECEx BVS 08.0041 U
ATEX marking	II 3G Ex nA IIC Gc
	II 2D Ex tb IIIC Db IP65/IP67
Mechanical data	
Weight [g]	186.4
Materials	housing: TPU orange
Material nut	stainless steel (1.4404 / 316L)
Remarks	
Pack quantity	1 pcs.

EVC16A



Connecting cable with plug

ASTAH040VAT0005H04/3G/2D

Electrical connection

Cable: 5 m, PUR, Halogen-free, black, Ø 4.9 mm; 4 x 0.34 mm² (42 x Ø 0.1 mm)

Electrical connection - plug

Connector: 1 x M12, angled; Locking: stainless steel (1.4404 / 316L); Contacts: gold-plated; Tightening torque: 1.2...1.5 Nm



Connection

1	BN
2	WH
3	BU
4	BK

Core colours :

BK =	black
BN =	brown
BU =	blue
WH =	white