

EVC227

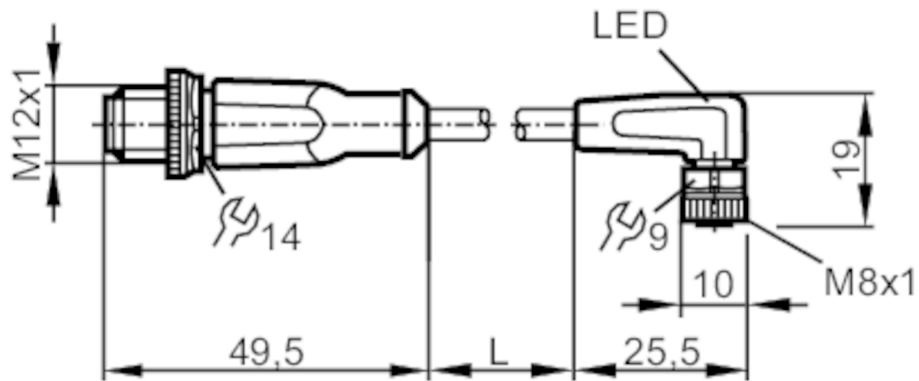

Connection cable

VDOAF032MSS0001H03STGH030MSS



Application

Free from silicone yes

Electrical data

Operating voltage [V] 10...36 DC

Protection class III

Max. current load total [A] 3

Outputs

Electrical design PNP

Operating conditions

Ambient temperature [°C] -25...90

Note on ambient temperature cULus: ...75

Ambient temperature (moving) [°C] -25...90

Note on ambient temperature (moving) cULus: ...75

Protection IP 65; IP 67; IP 68; IP 69K

Tests / approvals

MTTF [years] 31710

EVC227



Connection cable

VDOAF032MSS0001H03STGH030MSS

Mechanical data		
Weight [g]	54.6	
Materials	connector housing: TPU orange; socket housing: TPU black transparent; Sealing: FKM	
Material nut	brass / brass	
Drag chain suitability	bending radius for flexible use	min. 10 x cable diameter
	travel speed	max. 3.3 m/s for a horizontal travel length of 5 m and max. acceleration of 5 m/s ²
	bending cycles	> 5 Mio.
	torsional strain	± 180 °/m
Drag chain suitability	yes	

Displays / operating elements		
Display	switching status	1 x LED, yellow
	operation	1 x LED, green

Remarks	
Pack quantity	1 pcs.

Electrical connection
Cable: 1 m, PUR, Halogen-free, black, Ø 4.9 mm; 3 x 0.34 mm² (42 x Ø 0.1 mm)

Electrical connection - socket
Connector: 1 x M8, angled; Locking: brass, nickel-plated; Contacts: gold-plated; Tightening torque: 0.3...0.5 Nm

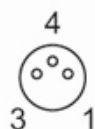

Electrical connection - plug
Connector: 1 x M12, straight; Locking: brass, nickel-plated; Contacts: gold-plated; Tightening torque: 0.6...1.5 Nm



EVC227



Connection cable

VDOAF032MSS0001H03STGH030MSS

Connection

