

E20716

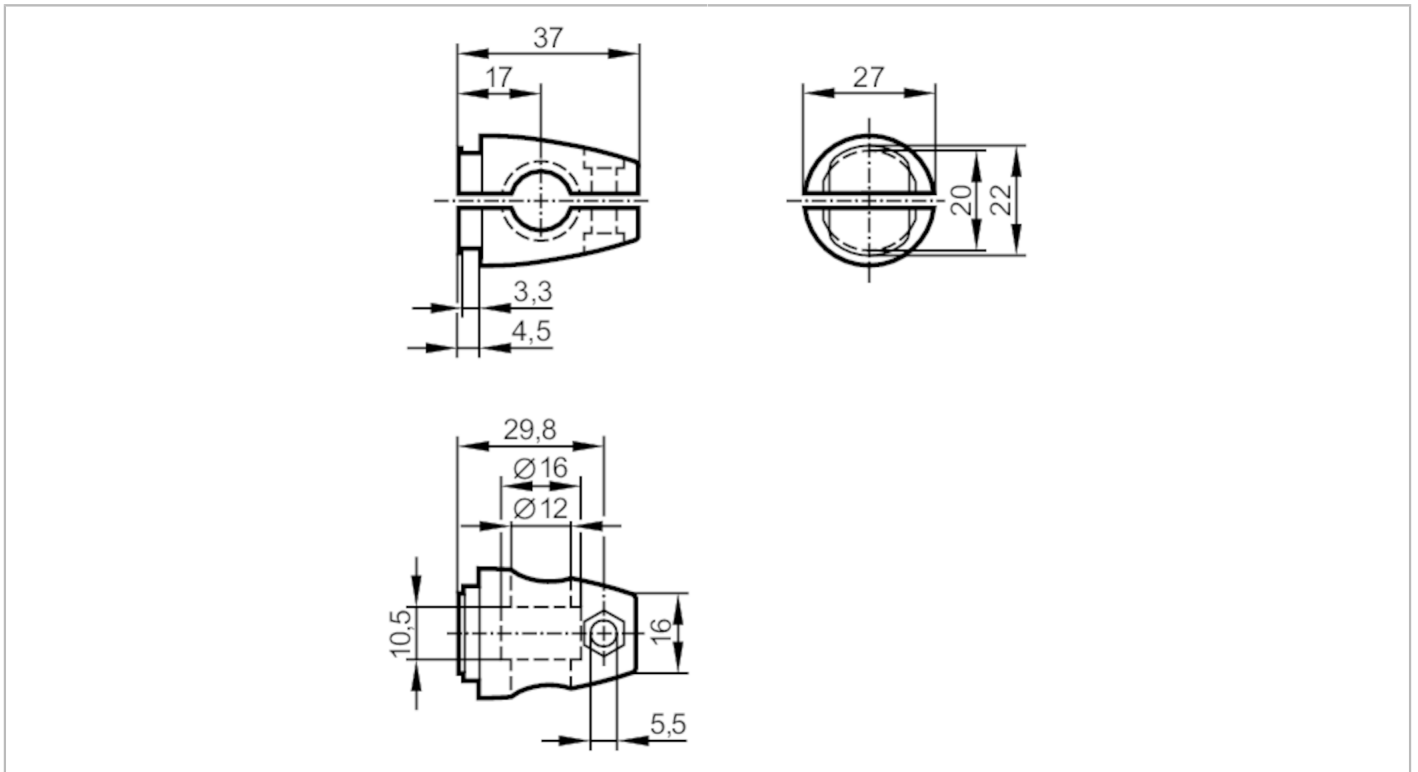

Mounting set for position sensors

CLAMP KF



Mechanical data

Weight	[g]	148
Type of mounting		free-standing; (M10)
Dimensions	[mm]	M10
Thread designation		M10
Materials		Clamp: diecast zinc

Accessories

Accessories (supplied)		head cap screw: 1 x M10 x 55
------------------------	--	------------------------------

Remarks

Pack quantity		1 pcs.
---------------	--	--------