

EVC707

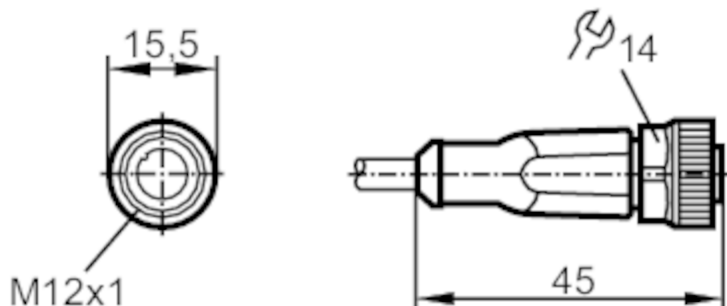

Connecting cable with socket

ADOGH040MSP0005H04



Application		
Free from silicone	yes	
Electrical data		
Operating voltage [V]	< 250 AC / < 300 DC	
Protection class	II	
Max. current load total [A]	4	
Operating conditions		
Ambient temperature [°C]	-25...90	
Ambient temperature (moving) [°C]	-25...90	
Protection	IP 65; IP 67; IP 68; IP 69K	
Mechanical data		
Weight [g]	343.8	
Dimensions [mm]	15.5 x 15.5 x 45	
Materials	housing: TPU orange; Sealing: FKM	
Material nut	brass	
Drag chain suitability	bending radius for flexible use	min. 10 x cable diameter
	travel speed	max. 3.3 m/s for a horizontal travel length of 5 m and max. acceleration of 5 m/s ²
	bending cycles	> 5 Mio.
	torsional strain	± 180 °/m
Drag chain suitability	yes	
Remarks		
Pack quantity	1 pcs.	

EVC707



Connecting cable with socket

ADOGH040MSP0005H04

Electrical connection

Cable: 5 m, PUR, Halogen-free, black, Ø 6.2 mm; 4 x 1.00 mm² (32 x Ø 0.2 mm)

Electrical connection - socket

Connector: 1 x M12, straight; Locking: brass, nickel-plated; Contacts: gold-plated; Tightening torque: 0.6...1.5 Nm

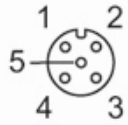

Connection

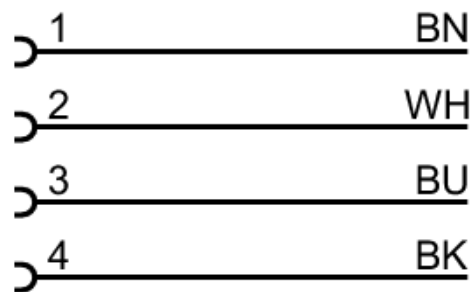

Core colours :

BK = black
BN = brown
BU = blue
WH = white