

# E11232

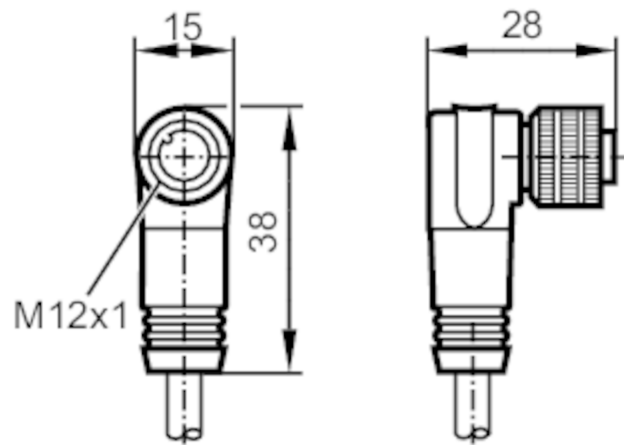

## Connecting cable with socket

ADOAH080MSS0005H08



### Application

Free from silicone yes

### Electrical data

Operating voltage [V] < 30 AC / < 36 DC  
Protection class III  
Max. current load total [A] 2; (...40 °C)

### Operating conditions

Ambient temperature [°C] -25...80  
Protection IP 67

### Mechanical data

Weight [g] 317.4  
Dimensions [mm] 28 x 15 x 38  
Materials PUR  
Material nut brass

### Remarks

Notes For 8-pole sockets the core colours are not standardised.; Please note the wiring of the sensor and the sockets (see data sheet).  
Pack quantity 1 pcs.

### Electrical connection

Cable: 5 m, PUR, Halogen-free, black, Ø 6.2 mm; 8 x 0.25 mm<sup>2</sup>

### Electrical connection - socket

Connector: 1 x M12, angled; Moulded body: PUR; Locking: brass, nickel-plated; Contacts: gold-plated; Tightening torque: 0.7...0.9 Nm

# E11232



## Connecting cable with socket

ADOAH080MSS0005H08



### Connection

1	BN
2	WH
3	BU
4	BK
5	GY
6	PK
7	VT
8	OG

colours to DIN EN 60947-5-2

Core colours :

BK =	black
BN =	brown
BU =	blue
GY =	grey
PK =	pink
OG =	orange
VT =	lilac
WH =	white