

TM4431

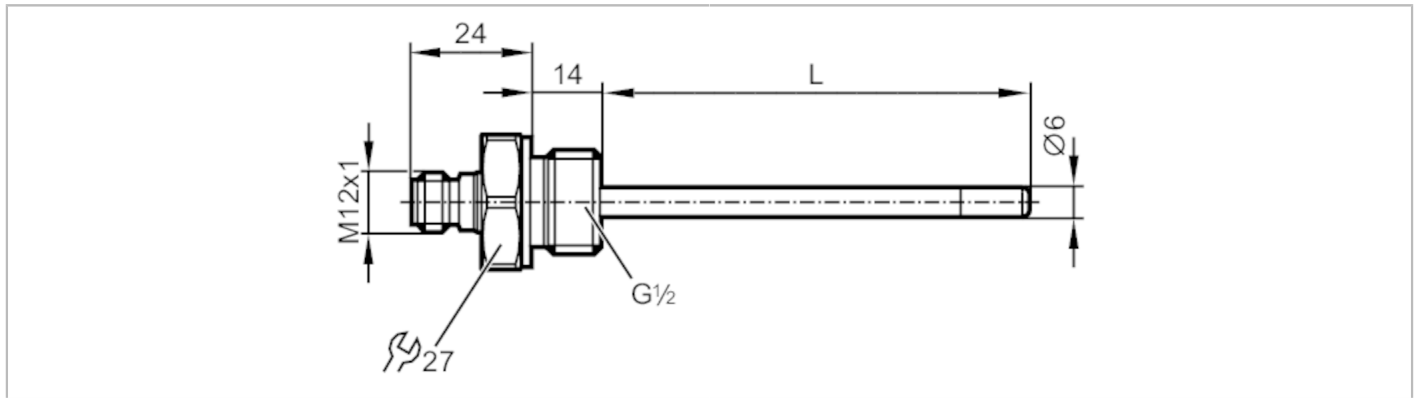

Temperature sensor with process connection

TM-100KFBR12- /US/



Application		
Measuring element	1 x Pt 100; (to DIN EN 60751, class A)	
Media	liquids and gases	
Pressure rating [bar]	160	
Minimum installation depth [mm]	15	
Electrical data		
Protection class	III	
Measuring/setting range		
Probe length L [mm]	86	
Measuring range	-40...150 °C	-40...302 °F
Accuracy / deviations		
Accuracy [K]	± (0,15 K + 0,002 x t)	
Response times		
Dynamic response T05 / T09 [s]	1 / 3; (to DIN EN 60751)	
Operating conditions		
Ambient temperature [°C]	-25...80	
Storage temperature [°C]	-40...100	
Protection	IP 68; IP 69K	
Tests / approvals		
Shock resistance	DIN EN 60068-2-2-27	50 g (11 ms)
Vibration resistance	DIN EN 60068-2-6	10 g (10...2000 Hz)
MTTF [years]	22831	
Mechanical data		
Weight [g]	129.6	
Materials	stainless steel (1.4404 / 316L)	
Materials (wetted parts)	stainless steel (1.4404 / 316L); FKM	
Process connection	threaded connection G 1/2	
Probe diameter [mm]	6	
Installation length EL [mm]	100	

TM4431



Temperature sensor with process connection

TM-100KFBR12-

/US/

Remarks

Remarks

operating voltage "supply class 2" according to cULus

The values for accuracy apply to flowing water.

Pack quantity

1 pcs.

Electrical connection

Connector: 1 x M12; Contacts: gold-plated



Connection

