

# E37230

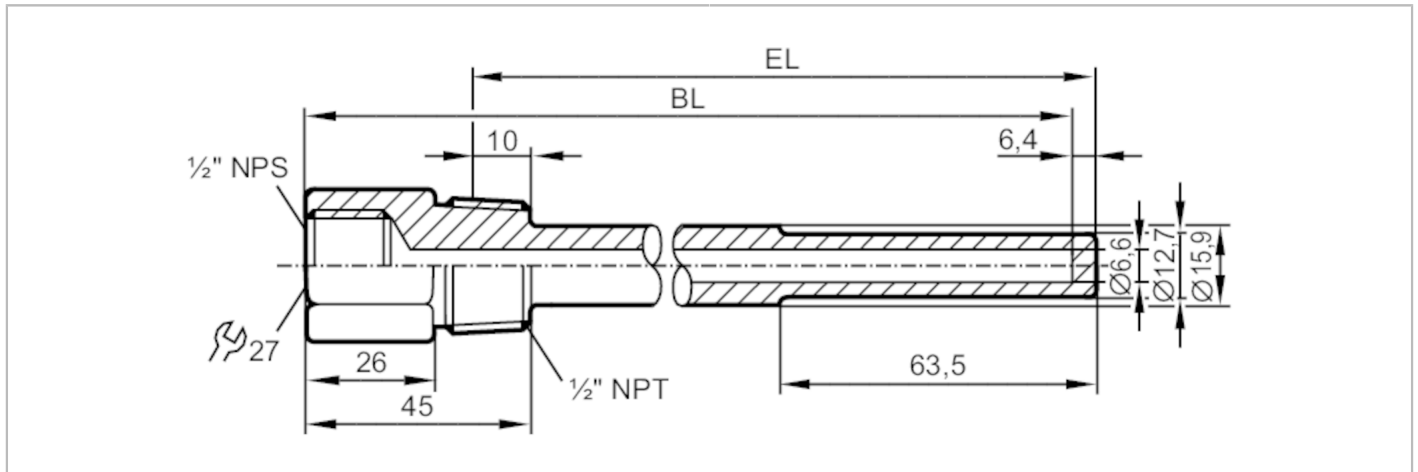

## Thermowell for temperature sensors

THERMOWELL, D6/1/2"NPT/L=230



Application	
Design	for temperature sensors EL = 300 mm
Pressure rating [bar]	400
Accuracy / deviations	
Max. permissible flow velocity [m/s]	12
Mechanical data	
Weight [g]	354.6
Materials	stainless steel (1.4404 / 316L)
Sensor connection	1/2 NPS Ø 6 mm suitable for G1/2 and 1/2" NPT
Process connection	1/2 NPT
Installation length EL [mm]	201
Bore length BL [mm]	228.6
Remarks	
Pack quantity	1 pcs.