

EVF009

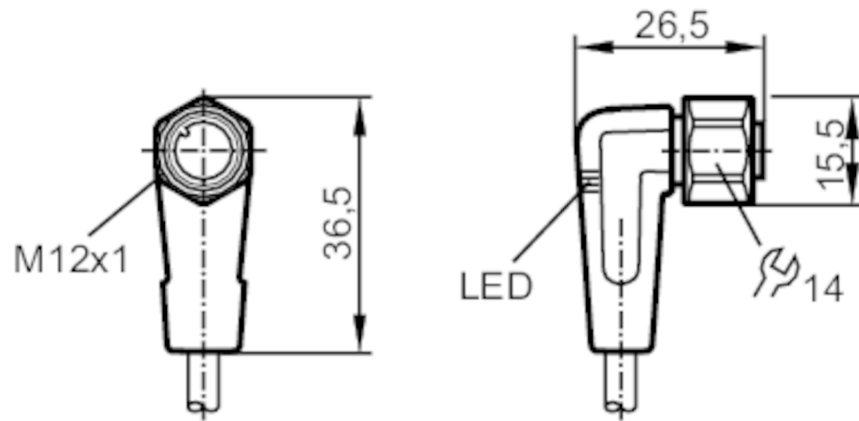

Connecting cable with socket

ADOAH043VAS0025P04



Application

Application	hygienic and wet areas in the food industry
Free from silicone	yes

Electrical data

Operating voltage	[V]	10...36 DC
Protection class		II
Max. current load total	[A]	4

Outputs

Electrical design	PNP
-------------------	-----

Operating conditions

Ambient temperature	[°C]	-25...100
Note on ambient temperature		cULus: ...65 °C
Ambient temperature (moving)	[°C]	0...100
Note on ambient temperature (moving)		cULus: ...65 °C
Protection		IP 65; IP 67; IP 68; IP 69K

EVF009



Connecting cable with socket

ADOAH043VAS0025P04

Mechanical data		
Weight [g]	754.5	
Dimensions [mm]	26.5 x 15.5 x 36.5	
Materials	PP Halogen-free; Sealing: EPDM	
Material nut	stainless steel (1.4404 / 316L)	
Drag chain suitability	bending radius for flexible use	min. 10 x cable diameter
	travel speed	max. 3.3 m/s for a horizontal travel length of 5 m and max. acceleration of 5 m/s ²
	bending cycles	> 1 Mio.
	torsional strain	± 180 °/m
Drag chain suitability	yes	

Displays / operating elements		
Display	switching status	2 x LED, yellow
	operation	1 x LED, green

Remarks	
Pack quantity	1 pcs.

Electrical connection	
Cable: 25 m, MPPE, grey, Ø 4.9 mm; 4 x 0.34 mm ² (42 x Ø 0.1 mm)	

Electrical connection - socket	
Connector: 1 x M12, angled; Moulded body: PP, Halogen-free; Locking: stainless steel (1.4404 / 316L); Contacts: gold-plated; Tightening torque: 0.6...1.5 Nm	

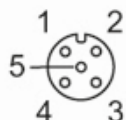

EVF009



Connecting cable with socket

ADOAH043VAS0025P04

Connection



Core colours :

BK =	black
BN =	brown
BU =	blue
WH =	white