

EVF001

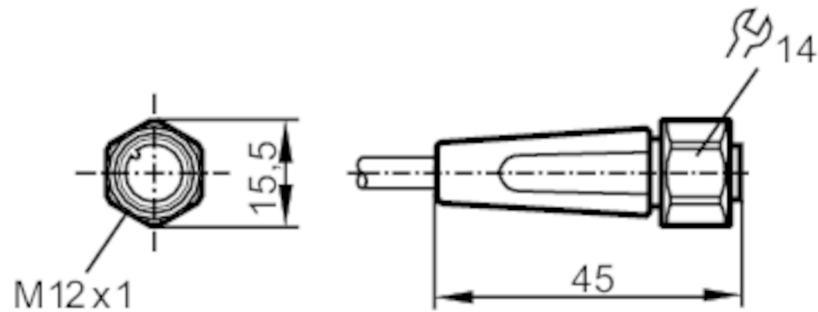

Connecting cable with socket

ADOGH040VAS0005P04



Application

Application	hygienic and wet areas in the food industry
Free from silicone	yes

Electrical data

Operating voltage [V]	< 250 AC / < 300 DC
Protection class	II
Max. current load total [A]	4

Operating conditions

Ambient temperature [°C]	-25...100
Note on ambient temperature	cULus: ...65 °C
Ambient temperature (moving) [°C]	0...100
Note on ambient temperature (moving)	cULus: ...65 °C
Protection	IP 65; IP 67; IP 68; IP 69K

EVF001



Connecting cable with socket

ADOGH040VAS0005P04

Mechanical data		
Weight [g]	164.8	
Dimensions [mm]	15.5 x 15.5 x 45	
Materials	PP Halogen-free; Sealing: EPDM	
Material nut	stainless steel (1.4404 / 316L)	
Drag chain suitability	bending radius for flexible use	min. 10 x cable diameter
	travel speed	max. 3.3 m/s for a horizontal travel length of 5 m and max. acceleration of 5 m/s ²
	bending cycles	> 1 Mio.
	torsional strain	± 180 °/m
Drag chain suitability	yes	

Remarks	
Pack quantity	1 pcs.

Electrical connection	
Cable: 5 m, MPPE, Halogen-free, grey, Ø 4.9 mm; 4 x 0.34 mm ² (42 x Ø 0.1 mm)	

Electrical connection - socket	
Connector: 1 x M12, straight; Moulded body: PP, Halogen-free; Locking: stainless steel (1.4404 / 316L); Contacts: gold-plated; Tightening torque: 0.6...1.5 Nm	



EVF001



Connecting cable with socket

ADOGH040VAS0005P04

Connection

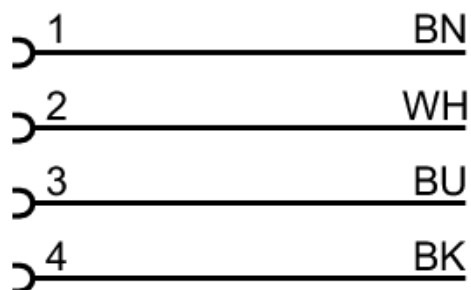

Core colours :

BK =	black
BN =	brown
BU =	blue
WH =	white