

SIRIUS SAFETY RELAY BASIC UNIT ADVANCED SERIES WITH
TIME DELAY 0.5-30S ELECTRONIC ENABLING CIRCUITS 2
INSTANTANEOUS 2 DELAYED US = 24 V DC SCREW TERMINAL



Figure similar

General technical data:	
product brand name	SIRIUS
Product designation	Advanced basic units
Design of the product	For autonomous safety applications
Protection class IP of the enclosure	IP20
Protection against electrical shock	finger-safe
Insulation voltage rated value	50 V
Ambient temperature	
• during storage	-40 ... +80 °C
• during operation	-25 ... +60 °C
Air pressure acc. to SN 31205	90 kPa ... 106 kPa
Relative humidity during operation	10 ... 95 %
Installation altitude at height above sea level maximum	2 000 m
Vibration resistance acc. to IEC 60068-2-6	5 ... 500 Hz: 0,75 mm
Shock resistance	10g / 11 ms
Surge voltage resistance rated value	500 V
EMC emitted interference	IEC 60947-5-1, Class A

Installation environment regarding EMC	This product is suitable for Class A environments only. It can cause undesired radio-frequency interference in residential environments. If this is the case, the user must take appropriate measures.
Overvoltage category	3
Degree of pollution	3
Number of sensor inputs 1-channel or 2-channel	1
Design of the cascading	yes
Type of the safety-related wiring of the inputs	single-channel and two-channel
Product feature cross-circuit-proof	Yes
Safety Integrity Level (SIL)	
• acc. to IEC 61508	SIL3
• for delayed release circuit acc. to IEC 61508	SIL3
Performance level (PL)	
• acc. to EN ISO 13849-1	e
• for delayed release circuit acc. to EN ISO 13849-1	e
Category acc. to EN ISO 13849-1	4
Safe failure fraction (SFF)	99 %
PFHD with high demand rate acc. to EN 62061	0.0000000015 1/h
PFDavg with low demand rate acc. to IEC 61508	0.000007
T1 value for proof test interval or service life acc. to IEC 61508	20 y
Hardware fault tolerance acc. to IEC 61508	1
Safety device type acc. to IEC 61508-2	Type B
Number of outputs as contact-affected switching element	
• as NC contact	
— for signaling function instantaneous contact	0
— for signaling function delayed switching	0
— safety-related instantaneous contact	0
— safety-related delayed switching	0
• as NO contact	
— for signaling function instantaneous contact	0
— for signaling function delayed switching	0
— safety-related instantaneous contact	0
— safety-related delayed switching	0
Number of outputs as contact-less semiconductor switching element	
• safety-related	
— delayed switching	2
— instantaneous contact	2

• for signaling function instantaneous contact	0
Stop category acc. to DIN EN 60204-1	0 / 1

General technical data:

Design of input	
• cascading input/functional switching	Yes
• feedback input	Yes
• Start input	Yes
Type of electrical connection Plug-in socket	No
Operating frequency maximum	2 000 1/h
Switching capacity current	
• of semiconductor outputs at DC-13 at 24 V	2 A
Design of the fuse link for short-circuit protection of the NO contacts of the relay outputs required	not required
Wire length	
• with Cu 1.5 mm ² and 150 nF/km per sensor circuit maximum	4 000 m
Make time with automatic start	
• at DC maximum	85 ms
Make time with automatic start after power failure	
• typical	6 500 ms
• maximum	6 500 ms
Make time with monitored start	
• maximum	85 ms
Backslide delay time after opening of the safety circuits typical	40 ms
Backslide delay time in the event of power failure	
• typical	0 ms
• maximum	0 ms
Adjustable OFF-delay time after opening of the safety circuits	0.5 ... 30
Recovery time after opening of the safety circuits typical	30 ms
Recovery time after power failure typical	6.5 s
Pulse duration	
• of the sensor input minimum	60 ms
• of the ON pushbutton input minimum	0.15 s

Control circuit/ Control:

Type of voltage of the control supply voltage	DC
Control supply voltage	
• at DC	
— rated value	24 V
Operating range factor control supply voltage rated value of magnet coil	

• at DC	0.8 ... 1.2
Power loss [W] typical	2 W
Installation/ mounting/ dimensions:	
Mounting position	any
Required spacing for grounded parts at the side	5 mm
Required spacing with side-by-side mounting at the side	0 mm
Mounting type	screw and snap-on mounting
Width	22.5 mm
Height	100 mm
Depth	121.6 mm
Connections/ Terminals:	
Type of electrical connection	screw-type terminals
Type of connectable conductor cross-sections	
• solid	1x (0.5 ... 2.5 mm ²), 2x (1.0 ... 1.5 mm ²)
• finely stranded — with core end processing	1x (0.5 ... 2.5 mm ²), 2x (0.5 ... 1.0 mm ²)
Type of connectable conductor cross-sections at AWG conductors	
• solid	1x (20 ... 14), 2x (18 ... 16)
• stranded	1x (20 ... 16), 2x (20 ... 16)
Product Function:	
Product function parameterizable	Sensor floating / sensor non-floating, monitored start / autostart, 1-channel / 2-channel sensor connection, cross-circuit detection, startup testing, antivalent sensors, 2-hand switches, time delay
Suitability for operation Device connector 3ZY12	Yes
Suitability for interaction press control	Yes
Suitability for use	
• safety switch	Yes
• Monitoring of floating sensors	Yes
• Monitoring of non-floating sensors	Yes
• magnetically operated switch monitoring	Yes
• safety-related circuits	Yes
Certificates/approvals	

General Product Approval	EMC	Functional Safety/Safety of Machinery
--------------------------	-----	---------------------------------------



CCC



CSA



UL



C-Tick

[Baumusterbescheinigung](#)

Declaration of Conformity	Test Certificates	Shipping Approval	other	Railway
---------------------------	-------------------	-------------------	-------	---------



EG-Konf.

[Typprüfbescheinigung/Werkszeugnis](#)



LRS



RMRS

[Bestätigungen](#)

[Bestätigungen](#)

Further information

Information- and Downloadcenter (Catalogs, Brochures,...)

<http://www.siemens.com/industrial-controls/catalogs>

Industry Mall (Online ordering system)

<https://mall.industry.siemens.com/mall/en/en/Catalog/product?mlfb=3SK1122-1CB42>

Cax online generator

<http://support.automation.siemens.com/WW/CAXorder/default.aspx?lang=en&mlfb=3SK1122-1CB42>

Service&Support (Manuals, Certificates, Characteristics, FAQs,...)

<https://support.industry.siemens.com/cs/ww/en/ps/3SK1122-1CB42>

Image database (product images, 2D dimension drawings, 3D models, device circuit diagrams, EPLAN macros, ...)

http://www.automation.siemens.com/bilddb/cax_de.aspx?mlfb=3SK1122-1CB42&lang=en

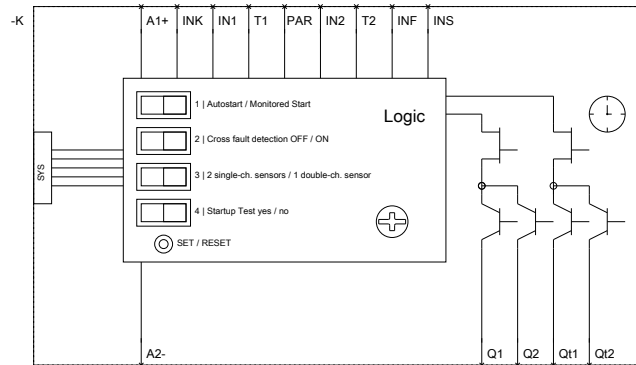
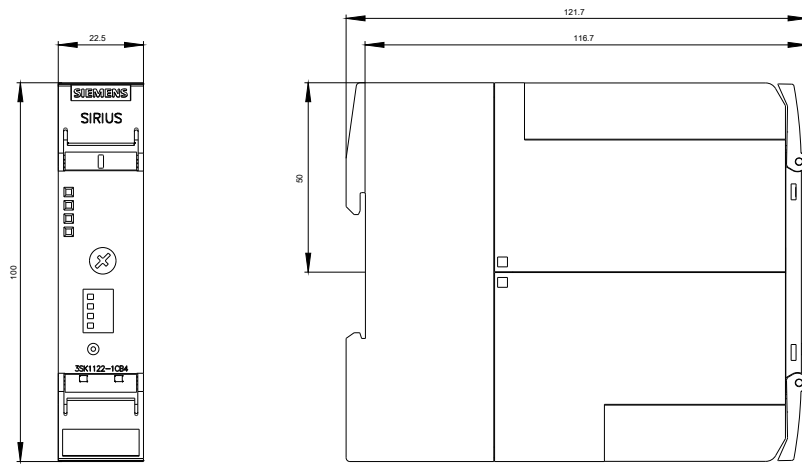

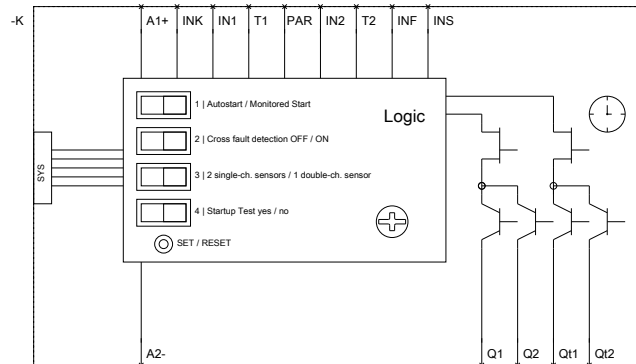

last modified:

10/07/2016