

Draw-out circuit breaker with slide-in module frame 3-pole, Size 3, IEC In=4000 A up to 690 V, 50/60 Hz AC Icu=100 kA at 500 V with connecting flange Overcurrent release ETU 45 LSING protection adjustable 0.4-1 in with display and cubicle bus with ground fault protection Opt.: Comm./measuring func./ZSS Motorized/manual operating mechanism with spring charging motor AC 50/60 Hz 208-240 V or 220-250 V DC Activation AC 50/60 Hz 230 V, 220 V DC With 1st auxiliary release Shunt release "F", F1 50/60 Hz 230 V AC/220 V DC, 100% on-load factor With 2nd auxiliary release "R", F3 Undervoltage, instant. 208-240 V AC, 220-250 V DC 4NO+4NC C01= Mechanical switching cycle counter C22= Ready indicator F12= COM16 Modbus module with breaker status sensor R15= Position signaling switch, withdrawable part 3 changeover contacts

Further information

Information on the packaging

<https://support.industry.siemens.com/cs/ww/en/view/109813875>

Industry Mall (Online ordering system)

<https://mall.industry.siemens.com/mall/en/en/Catalog/product?mlfb=3WL1340-4FG68-4GN4-Z C01+C22+F12+R15>

Service&Support (Manuals, Certificates, Characteristics, FAQs,...)

<https://support.industry.siemens.com/cs/ww/en/ps/3WL1340-4FG68-4GN4-Z C01+C22+F12+R15>

Image database (product images, 2D dimension drawings, 3D models, device circuit diagrams, ...)

http://www.automation.siemens.com/bilddb/cax_en.aspx?mlfb=3WL1340-4FG68-4GN4-Z C01+C22+F12+R15

CAX-Online-Generator

<http://www.siemens.com/cax>

Tender specifications

<http://www.siemens.com/specifications>

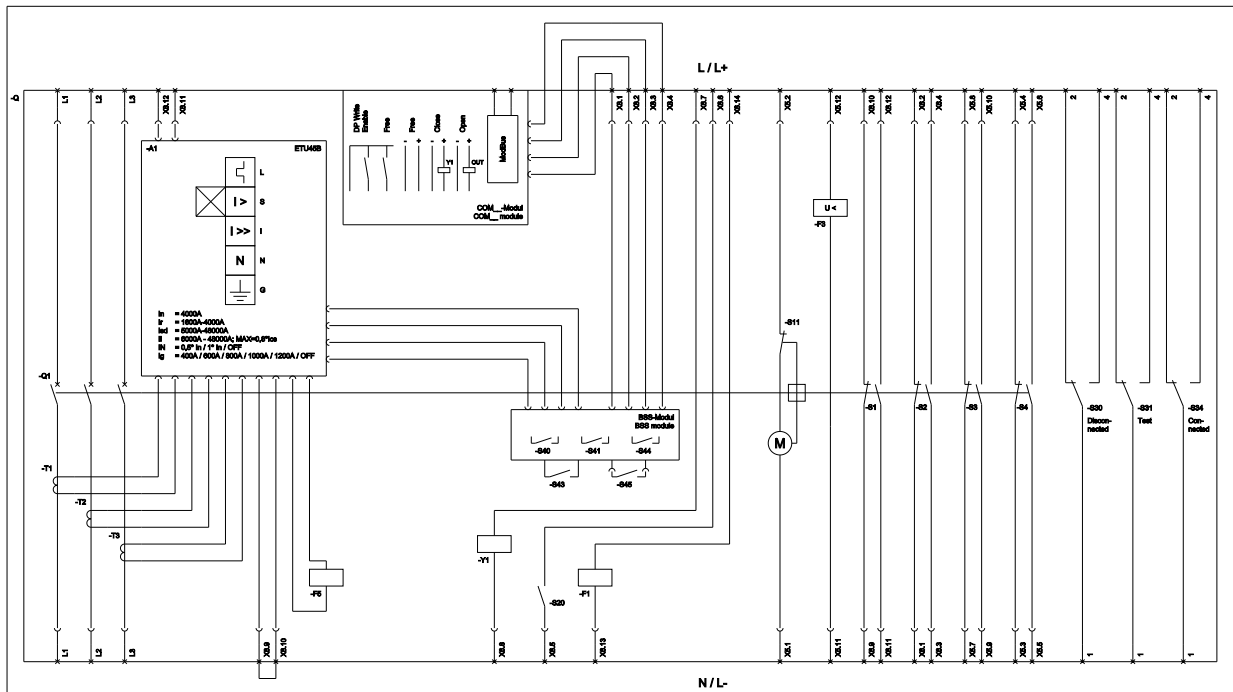

last modified:

3/14/2024

