

ACCESSORY FOR VL160X, VL160, VL250, CONNECTING CABLE
0,5M

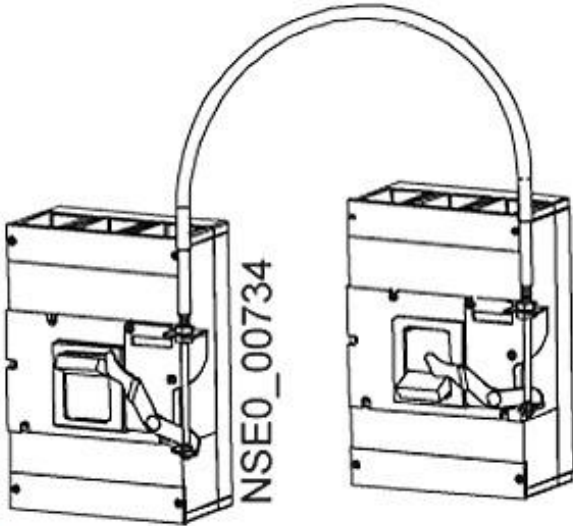







Figure similar

Model	
product brandname	SETRON
Accessories	
accessories	Accessories for...VL160, VL250

General Product Approval	EMC	Declaration of Conformity	Test Certificates	Shipping Approval
sonstig	 EAC	 C-Tick	 EG-Konf.	spezielle Prüfbescheinigungen n  PRS

Shipping Approval	other
 RINA	 RMRS
	Bestätigungen Umweltbestätigung sonstig

Further information

Information- and Downloadcenter (Catalogs, Brochures,...)

<http://www.siemens.com/lowvoltage/catalogs>

Industry Mall (Online ordering system)

<https://eb.automation.siemens.com/mall/en/WW/Catalog/Product/3VL9000-8LH10>

Service&Support (Manuals, Certificates, Characteristics, FAQs,...)

<http://support.automation.siemens.com/WW/view/en/3VL9000-8LH10/all>

Image database (product images, 2D dimension drawings, 3D models, device circuit diagrams, ...)

http://www.automation.siemens.com/bilddb/cax_en.aspx?mlfb=3VL9000-8LH10

CAX-Online-Generator

<http://www.siemens.com/cax>

Tender specifications

<http://www.siemens.com/specifications>