



## Main

Range of product	Altivar 212
Product or component type	Variable speed drive
Device short name	ATV212
Product destination	Asynchronous motors
Product specific application	Pumps and fans in HVAC
Assembly style	With heat sink
Network number of phases	3 phases
Motor power kW	18.5 kW
Motor power hp	25 hp
Power supply voltage	380...480 V (- 15...10 %)
Power supply voltage limits	323...528 V
Supply frequency	50...60 Hz (- 5...5 %)
Network frequency	47.5...63 Hz
EMC filter	Class C2 EMC filter integrated
Line current	34.8 A for 380 V 27.8 A for 480 V

## Complementary

Apparent power	28.2 kVA for 380 V
Prospective line I <sub>sc</sub>	22 kA
Continuous output current	37 A at 380/460 V
Maximum transient current	40.7 A for 60 s
Speed drive output frequency	0.5...200 Hz
Nominal switching frequency	8 kHz
Switching frequency	8...16 kHz with derating factor 6...16 kHz adjustable
Speed range	1...10
Speed accuracy	+/- 10 % of nominal slip for 0.2 T <sub>n</sub> to T <sub>n</sub> torque variation
Torque accuracy	+/- 15 %
Transient overtorque	120 % of nominal motor torque, +/- 10 % for 60 s
Asynchronous motor control profile	Voltage/Frequency ratio, 2 points Voltage/Frequency ratio, 5 points Flux vector control without sensor, standard Voltage/Frequency ratio - Energy Saving, quadratic U/f Voltage/Frequency ratio, automatic IR compensation (U/f + automatic U <sub>0</sub> )
Regulation loop	Adjustable PI regulator
Motor slip compensation	Adjustable Automatic whatever the load Not available in voltage/frequency ratio motor control
Local signalling	1 LED - red - DC bus energized
Output voltage	<= power supply voltage
Isolation	Electrical between power and control
Type of cable for external connection	UL 508 cable with UL Type 1 kit: 3 wire(s) - 40 °C, copper 75 °C / PVC IEC cable without mounting kit: 1 wire(s) - 45 °C, copper 70 °C / PVC IEC cable without mounting kit: 1 wire(s) - 45 °C, copper 90 °C / XLPE/EPR

The information provided in this documentation contains general descriptions and/or technical characteristics of the performance of the products contained herein. This documentation is not intended as a substitute for and is not to be used for determining suitability or reliability of these products for specific user applications. It is the duty of any such user or integrator to perform the appropriate and complete risk analysis, evaluation and testing of the products with respect to the relevant specific application or use thereof. Neither Schneider Electric Industries SAS nor any of its affiliates or subsidiaries shall be responsible or liable for misuse of the information contained herein.

Electrical connection	Terminal 25 mm <sup>2</sup> / AWG 3 (L1/R, L2/S, L3/T) Terminal 2.5 mm <sup>2</sup> / AWG 14 (VIA, VIB, FM, FLA, FLB, FLC, RY, RC, F, R, RES)
Tightening torque	4.5 N.m - 40 lb.in (L1/R, L2/S, L3/T) 0.6 N.m (VIA, VIB, FM, FLA, FLB, FLC, RY, RC, F, R, RES)
Supply	Internal supply: 24 V (21...27 V) DC - <= 200 A with overload and short-circuit protection Internal supply for reference potentiometer (1 to 10 kOhm): 10.5 V DC, +/- 5 % - <= 10 A with overload and short-circuit protection
Analogue input number	2
Analogue input type	Configurable voltage: (VIB) 0...10 V DC - 24 V max - 30000 Ohm - resolution: 10 bits Switch-configurable current: (VIA) 0...20 mA - 250 Ohm - resolution: 10 bits Switch-configurable voltage: (VIA) 0...10 V DC - 24 V max - 30000 Ohm - resolution: 10 bits Configurable PTC probe: (VIB) 0...6 probes - 1500 Ohm
Sampling duration	22 ms +/- 0.5 ms (VIB) - analog input(s) 3.5 ms +/- 0.5 ms (VIA) - analog input(s) 2 ms +/- 0.5 ms (RES) - discrete input(s) 2 ms +/- 0.5 ms (R) - discrete input(s) 2 ms +/- 0.5 ms (F) - discrete input(s)
Response time	7 ms +/- 0.5 ms (RY, RC) - discrete output(s) 7 ms +/- 0.5 ms (FLB, FLC) - discrete output(s) 7 ms +/- 0.5 ms (FLA, FLC) - discrete output(s) 2 ms +/- 0.5 ms (FM) - analog output(s)
Accuracy	+/- 1 % (FM) for a temperature variation 60 °C +/- 0.6 % (VIB) for a temperature variation 60 °C +/- 0.6 % (VIA) for a temperature variation 60 °C
Linearity error	+/- 0.2 % for output (FM) +/- 0.15 % of maximum value for input (VIB) +/- 0.15 % of maximum value for input (VIA)
Analogue output number	1
Analogue output type	Switch-configurable current: (FM) 0...20 mA - 970 Ohm - resolution: 10 bits Switch-configurable voltage: (FM) 0...10 V DC - 7620 Ohm - resolution: 10 bits
Discrete output number	2
Discrete output type	Configurable relay logic: (RY, RC) NO - 100000 cycles Configurable relay logic: (FLB, FLC) NC - 100000 cycles Configurable relay logic: (FLA, FLC) NO - 100000 cycles
Minimum switching current	3 mA at 24 V DC (configurable relay logic)
Maximum switching current	2 A at 30 V DC on inductive load - cos phi = 0.4 - L/R = 7 ms (FL, R) 2 A at 250 V AC on inductive load - cos phi = 0.4 - L/R = 7 ms (FL, R) 5 A at 30 V DC on resistive load - cos phi = 1 - L/R = 0 ms (FL, R) 5 A at 250 V AC on resistive load - cos phi = 1 - L/R = 0 ms (FL, R)
Discrete input type	Programmable (RES) 24 V DC, with level 1 PLC - 4700 Ohm Programmable (R) 24 V DC, with level 1 PLC - 4700 Ohm Programmable (F) 24 V DC, with level 1 PLC - 4700 Ohm
Discrete input logic	Negative logic (sink) (F, R, RES), >= 16 V (state 0), <= 10 V (state 1) Positive logic (source) (F, R, RES), <= 5 V (state 0), >= 11 V (state 1)
Acceleration and deceleration ramps	Automatic based on the load Linear adjustable separately from 0.01 to 3200 s
Braking to standstill	By DC injection
Protection type	With PTC probes for motor Motor phase break for motor Thermal protection for motor Against input phase loss for drive Line supply undervoltage for drive Line supply overvoltage and undervoltage for drive Against exceeding limit speed for drive Break on the control circuit for drive Overvoltages on the DC bus for drive Overcurrent between output phases and earth for drive Input phase breaks for drive Short-circuit between motor phases for drive Thermal power stage for drive Overheating protection for drive
Dielectric strength	5092 V DC between control and power terminals 3535 V DC between earth and power terminals
Insulation resistance	>= 1 MOhm at 500 V DC for 1 minute
Frequency resolution	0.024/50 Hz for analog input 0.1 Hz for display unit

Communication port protocol	APOGEE FLN BACnet LonWorks METASYS N2 Modbus
Connector type	1 RJ45 1 open style
Physical interface	2-wire RS 485
Transmission frame	RTU
Transmission rate	9600 bps or 19200 bps
Data format	8 bits, 1 stop, odd even or no configurable parity
Type of polarization	No impedance
Number of addresses	1...247
Communication service	Monitoring inhibitable Read device identification (43) Read holding registers (03) 2 words maximum Time out setting from 0.1 to 100 s Write multiple registers (16) 2 words maximum Write single register (06)
Option card	Communication card for LonWorks
Operating position	Vertical +/- 10 degree
Width	245 mm
Height	330 mm
Depth	190 mm
Product weight	11.65 kg
Power dissipation in W	603 W
Fan flow rate	214 m3/h

## Environment

Electromagnetic compatibility	Voltage dips and interruptions immunity test conforming to IEC 61000-4-11 Conducted radio-frequency immunity test level 3 conforming to IEC 61000-4-6 1.2/50 $\mu$ s - 8/20 $\mu$ s surge immunity test level 3 conforming to IEC 61000-4-5 Electrical fast transient/burst immunity test level 4 conforming to IEC 61000-4-4 Radiated radio-frequency electromagnetic field immunity test level 3 conforming to IEC 61000-4-3 Electrostatic discharge immunity test level 3 conforming to IEC 61000-4-2
Pollution degree	2 IEC 61800-5-1
IP degree of protection	IP20 on upper part without blanking plate on cover conforming to EN/IEC 60529 IP20 on upper part without blanking plate on cover conforming to EN/IEC 61800-5-1 IP41 on upper part conforming to EN/IEC 60529 IP41 on upper part conforming to EN/IEC 61800-5-1 IP21 conforming to EN/IEC 60529 IP21 conforming to EN/IEC 61800-5-1
Vibration resistance	1 gn (f = 13...200 Hz) conforming to EN/IEC 60068-2-8 1.5 mm (f = 3...13 Hz) conforming to EN/IEC 60068-2-6
Shock resistance	15 gn for 11 ms conforming to IEC 60068-2-27
Environmental characteristic	Classes 3S2 conforming to IEC 60721-3-3 Classes 3C1 conforming to IEC 60721-3-3
Noise level	54 dB conforming to 86/188/EEC
Operating altitude	1000...3000 m (limited to 2000 m for the Corner Grounded distribution network) with current derating 1 % per 100 m <= 1000 m without derating
Relative humidity	5...95 % without dripping water conforming to IEC 60068-2-3 5...95 % without condensation conforming to IEC 60068-2-3
Ambient air temperature for operation	> 40...50 °C with derating factor -10...40 °C without derating
Ambient air temperature for storage	-25...70 °C

Standards	EN 55011 class A group 1 EN 61800-3 EN 61800-3 category C2 EN 61800-3 category C3 EN 61800-3 environments 1 category C1 EN 61800-3 environments 1 category C2 EN 61800-3 environments 1 category C3 EN 61800-3 environments 2 category C1 EN 61800-3 environments 2 category C2 EN 61800-3 environments 2 category C3 EN 61800-5-1 IEC 61800-3 IEC 61800-3 category C2 IEC 61800-3 category C3 IEC 61800-3 environments 1 category C1 IEC 61800-3 environments 1 category C2 IEC 61800-3 environments 1 category C3 IEC 61800-3 environments 2 category C1 IEC 61800-3 environments 2 category C2 IEC 61800-3 environments 2 category C3 IEC 61800-5-1 UL Type 1
Product certifications	CSA C-Tick NOM 117 UL
Marking	CE

## Offer Sustainability

Sustainable offer status	Green Premium product
RoHS	Compliant - since 1051 - <a href="#">Schneider Electric declaration of conformity</a>
REACH	Reference contains SVHC above the threshold - <a href="#">go to CaP for more details</a>
Product environmental profile	Available <a href="#">Download Product Environmental</a>
Product end of life instructions	Available <a href="#">Download End Of Life Manual</a>

Dimensions

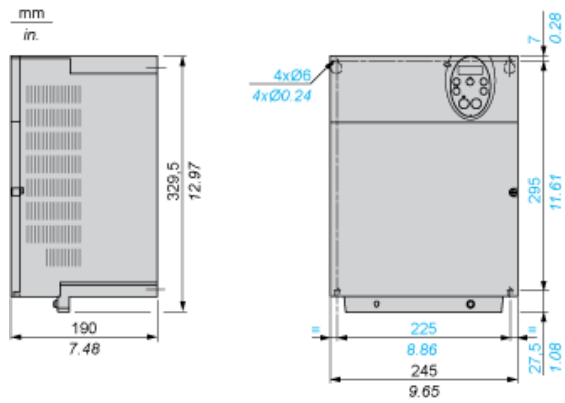
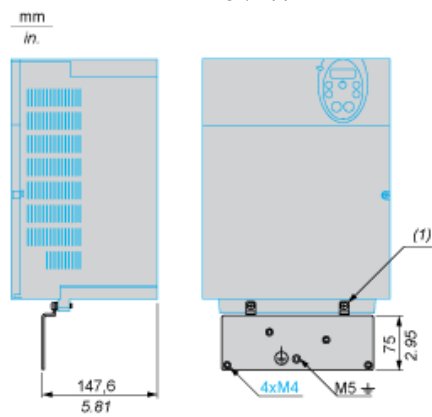

Plate for EMC mounting (supplied with the drive)



(1) 2 x M5 screws

Mounting Recommendations

Clearance

Depending on the conditions in which the drive is to be used, its installation will require certain precautions and the use of appropriate accessories.

Install the unit vertically:

- Do not place it close to heating elements.
- Leave sufficient free space to ensure that the air required for cooling purposes can circulate from bottom to the top of the unit.

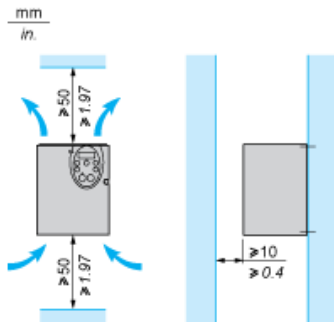

Mounting Types

Type A mounting

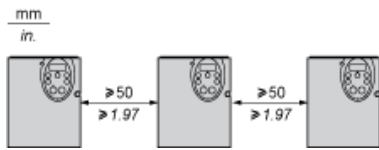

Type B mounting

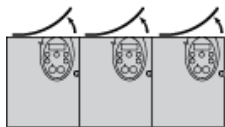

Type C mounting

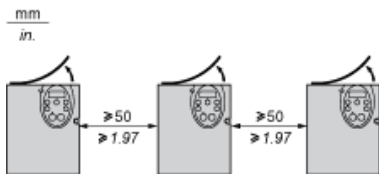

By removing the protective blanking cover from the top of the drive, the degree of protection for the drive becomes IP21. The protective blanking cover may vary according to the drive model, see opposite.

Specific Recommendations for Mounting in an Enclosure

To help ensure proper air circulation in the drive:

- Fit ventilation grilles.
- Check that there is sufficient ventilation. If there is not, install a forced ventilation unit with a filter. The openings and/or fans must provide a flow rate at least equal to that of the drive fans (refer to the product characteristics).

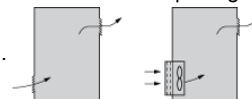

- Use special filters with UL Type 12/IP54 protection.
- Remove the blanking cover from the top of the drive.

### Sealed Metal Enclosure (IP54 Degree of Protection)

The drive must be mounted in a dust and damp proof enclosure in certain environmental conditions, such as dust, corrosive gases, high humidity with risk of condensation and dripping water, splashing liquid, etc. This enables the drive to be used in an enclosure where the maximum internal temperature reaches 50°C.

Recommended Wiring Diagram

3-Phase Power Supply

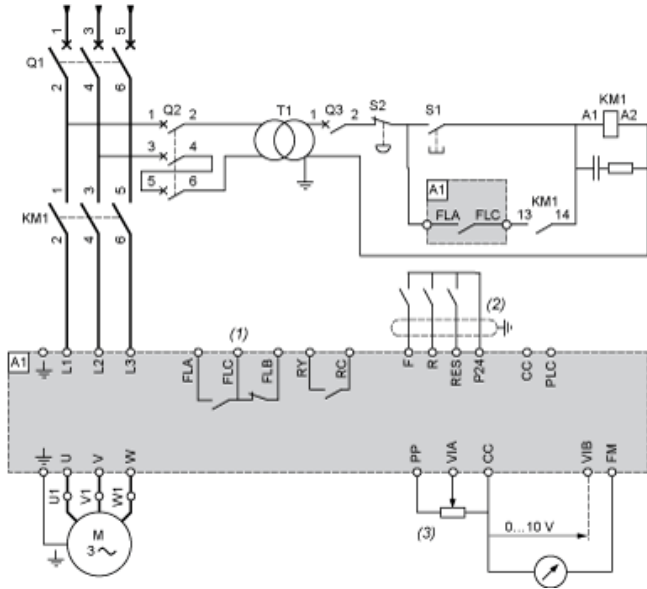

- A1: ATV 212 drive
- KM1: Contactor
- Q1: Circuit breaker
- Q2: GV2 L rated at twice the nominal primary current of T1
- Q3: GB2CB05
- S1, XB4 B or XB5 A pushbuttons
- S2:
- T1: 100 VA transformer 220 V secondary
- (1) Fault relay contacts for remote signalling of the drive status
- (2) Connection of the common for the logic inputs depends on the positioning of the switch (Source, PLC, Sink)
- (3) Reference potentiometer SZ1RV1202

All terminals are located at the bottom of the drive. Install interference suppressors on all inductive circuits near the drive or connected on the same circuit, such as relays, contactors, solenoid valves, fluorescent lighting, etc.

Switches (Factory Settings)

Voltage/current selection for analog I/O (VIA and VIB)



Voltage/current selection for analog I/O (FM)



Selection of logic type



- (1) negative logic
- (2) positive logic

Other Possible Wiring Diagrams



## Logic Inputs According to the Position of the Logic Type Switch

"Source" position

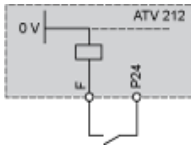

"Sink" position

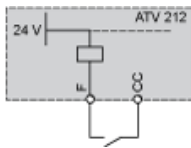

"PLC" position with PLC transistor outputs	
<p>(1) PLC</p>	<p>(1) PLC</p>

2-wire control

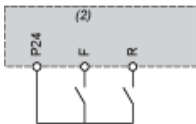

- F: Forward
- R: Preset speed
- (2) ATV 212 control terminals

3-wire control

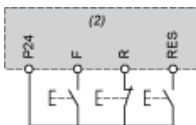

- F: Forward
- R: Stop
- RES: Reverse
- (2) ATV 212 control terminals

PTC probe

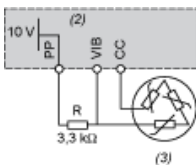

- (2) ATV 212 control terminals
- (3) Motor

## Analog Inputs

Voltage analog inputs

External +10 V	
<p>(2) ATV 212 control terminals (4) Speed reference potentiometer 2.2 to 10 kΩ</p>	<p>(2) ATV 212 control terminals</p>

Analog input configured for current: 0-20 mA, 4-20 mA, X-Y mA

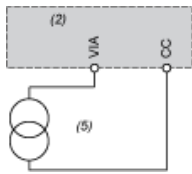

(2) ATV 212 control terminals

(5) Source 0-20 mA, 4-20 mA, X-Y mA

Analog input VIA configured as positive logic input ("Source" position)



(2) ATV 212 control terminals

Analog input VIA configured as negative logic input ("Sink" position)

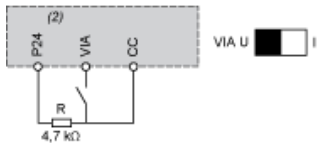

(2) ATV 212 control terminals

## Derating Curves

The derating curves for the drive nominal current ( $I_n$ ) depend on the temperature, the switching frequency and the mounting type (A, B or C). For intermediate temperatures (45°C for example), interpolate between 2 curves.

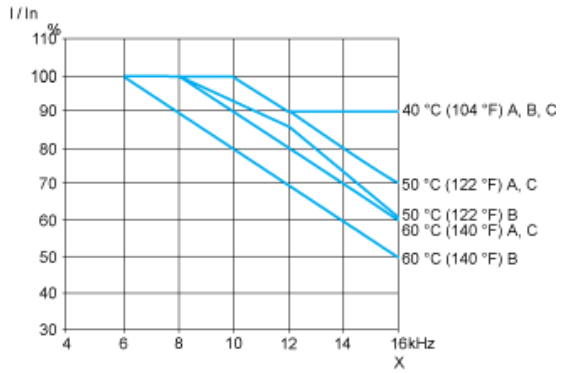

X Switching frequency