

CAP FOR D-BOX M12 8-WAY 5-POLE

No pot.-sep. 3m PUR/PVC-JB, 16x0,34+3x0,75

for 8-way distribution boxes, 5-pole

PUR/PVC

3.0 m

New Art.-No. 8000-88559-3980300

Plastic housings with good resistance against chemicals and oils.

The resistance to aggressive media should be individually tested for your application. Further details on request.

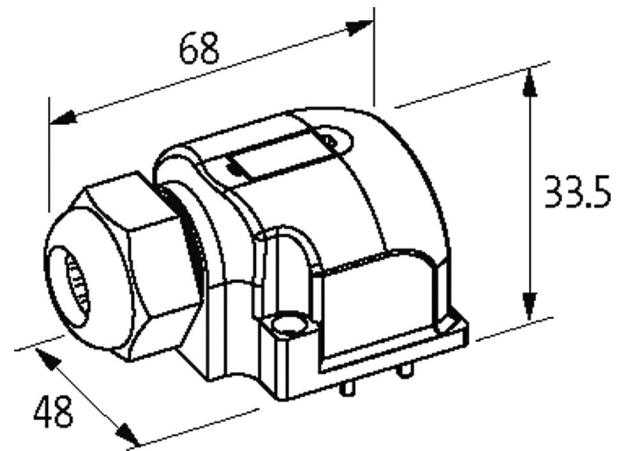
[Link to Product](#)**Illustration**

Product may differ from Image

**Technical Data**

Total current max. 8 A

General data

Dimensions HxWxD 33x48x68 mm

Cables

Cable number 398

No./diameter of wires 16x 0.34 + 3x 0.75 mm²

Wire isolation PVC

C-track properties 2 Mio.

Jacket Color gray

Material (jacket) PUR/PVC (UL/CSA)

Outer Ø 10.0 mm ±5%

Bend radius (moving) 10x outer Ø

Cable identification 398

Cable Type 2 (PUR/PVC)

Approval (cable) UL (AWM-Style 21441/10955), CE conform

Cable weight [g/m] 165,0

Material (wire) Cu wire, bare

Resistor (core) max. 57 Ω/km (0.34 mm²), max. 26 Ω/km (0.75 mm²); (20 °C)

Single wire Ø (core) 0.15 mm

The information in this brochure has been compiled with the utmost care.

Liability for the correctness completeness and topicality of the information is restricted to gross negligence. Version: 03/22

Murrelektronik Ltd. | 5 Albion Street, Pendlebury Industrial Estate, Swinton | Manchester M27 4FG | Fon +44 161 728 3133 | Fax +44 161 728 3130 | shop@murrelektronik.co.uk | shop.murrelektronik.co.uk

Construction (core)	19× 0.15 mm (0.34 mm ²); 42× 0.15 mm (0.75 mm ²); (multi-strand wire class 5/6)
Diameter (core)	16× 0.34 + 3× 0.75 mm ²
AWG	similar to AWG 22 (0.34 mm ²); similar to AWG 19 (0.75 mm ²)
Material (wire isolation)	PVC
Material property (wire isolation)	CFC-, cadmium-, silicone- and lead-free
Shore hardness (wire isolation)	43 ±5 D
Wire-Ø incl. isolation	1.3 mm ±5% (0.34 mm ²); 1.8 mm ±5% (0.75 mm ²)
Color/numbering of wires	wh, grpk, brgn, ye, whgn, gn, rdbl, vi, grbr, bk, whgr, rd, yebr, pk, whye, gr+bl, br, gnye longitudinally striped
Shield	no
Material (jacket)	PUR/PVC
Shore hardness (jacket)	87 ±5 A
Outer-Ø (jacket)	10.0 mm ±5%
Color (jacket)	gray
chemical resistance	good resistance to oil, gasoline and chemicals (EN 60811-404)
Nominal voltage	U0/U 300/300 V AC
Test voltage	2000 V AC
Current load capacity	to DIN VDE 0298-4
Temperature range (fixed)	-30...+80 °C
Temperature range (mobile)	-5...+60 °C
Bend radius (fixed)	5× outer Ø
Bend radius (moving)	10× outer Ø
No. of bending cycles (C-track)	max. 2 Mio. (25 °C)
Traversing distance (C-track)	max. 5 m (horizontal)
Travel speed (C-track)	max. 2 m/s
Acceleration (C-track)	max. 10 m/s ²

Commercial data

old articlenumber	8000-88559-3980300
country of origin	CZ
customs tariff number	85444290
EAN	4048879058339
eClass	27143423
Packaging unit	1